



Hoffman Specialty® General Catalog

HS-900G

ESP-PLUS™

For computer aided selection of Steam Trap and Regulators, please refer to the *Steam Specialty Component Selectors* at <http://bellgossett.com/selection-sizing-cad-tools/>

For a stand-alone version of ESP-PLUS, contact your local Bell & Gossett Representative.

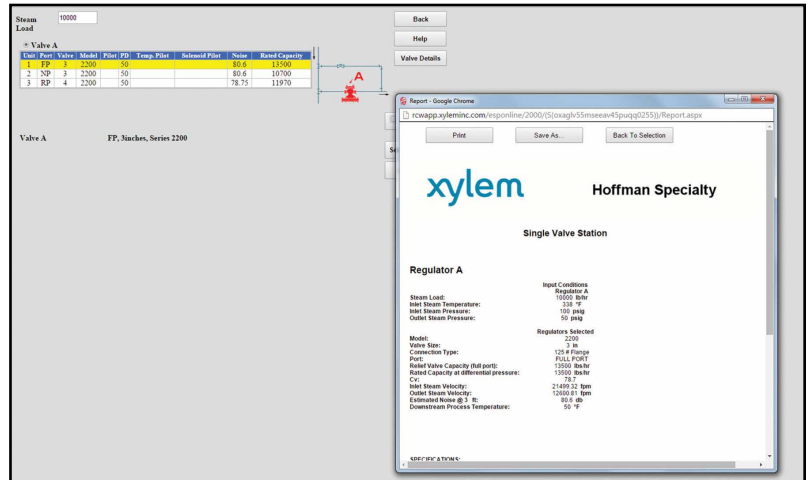

Hoffman Specialty® BEAR TRAP® Steam Traps

FLOAT AND THERMOSTATIC

SERIES

PAGE

How to Select

All

105



14



8



12



14

Competitive Changeover



18

THERMOSTATIC

8C



22

9C



23

17C



20

Competitive Changeover

17C



24

Replacement Modules

Dura-stat®



24

INVERTED BUCKET

SERIES

PAGE

B0



26

B1



28

B2



28

B3



32

B4



32

B6



38

THERMODISC

TD6520



40

TD6420



40

Steam Traps

Regulators

Vacuum Breakers

Vents

Valves













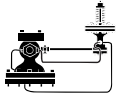





Y-Strainers

Pumps

















Heat Exchangers

Selection Guides









Hoffman Specialty® Regulators

	<u>PRESSURE</u> <i>(for Steam Service)</i>	<u>SERIES</u>	<u>PAGE</u>	<u>TEMPERATURE</u> <i>(for Steam Service)</i>	<u>SERIES</u>	<u>PAGE</u>
Steam Traps						
Regulators	Self-Contained Pressure Reducing	754 	58	Tempering Valves <i>(for Water Service)</i>	21 	78
Vacuum Breakers	Pilot Operated Typical Applications	2000 	42 120	Self-Activated <i>(for Steam or Water Service)</i>	1140 	60
Vents	Main Valves - How to Size Operation	All	115 111		1141 	60
	Pilots - How to Select Operation	All	118 111	Pilot Operated Typical Applications	2000 	42 120
	• Main Valves	2000 	43	Main Valves - How to Size Operation	All	115 111
	• Hardware Kits		49	Pilots - How to Select Operation	All	118 111
Valves	• Air Pressure Control	AP 	51	• Main Valves	2000 	44
	• Spring Pressure Control	SPS 	50	• Hardware Kits		49
Y-Strainers	• Solenoid	SLD 	57	• Air Pressure Control	AP 	51
Pumps				• Spring Pressure Control	SPS 	50
Heat Exchangers				• Temperature Control Self-Contained	STPA 	52
Selection Guides				Pneumatic	240 	55
					315 	54
				Electronic-pneumatic	GT610-1P 	56
				• Solenoid	SLD 	57



Hoffman Specialty® Vents

<u>STEAM</u>	<u>SERIES</u>	<u>PAGE</u>
How to Select 131	All	
Main	4A 	84
	75 	84
	76 	85
High Pressure	8C 	86
	3 	87
Special	4 	87
	74 	87
	1A 	88
Radiator	40 	88
	70A 	88
Convactor	1B 	89
	41 	89
	43 	89
	45 	89
	71 	89
	508 	89



Hoffman Specialty® Vents

<u>WATER</u>	<u>SERIES</u>	<u>PAGE</u>
How to Select	All	152
	77 	90
	78 	90
	79 	90
	508 	92
	550 	92
	790 	91
	791 	91
	792 	91

Hoffman Specialty® Valves

<u>DRAIN</u>	<u>SERIES</u>	<u>PAGE</u>
	793 	93
<u>SUPPLY</u>		
	185C 	94

Steam Traps
Regulators
Vacuum Breakers
Vents
Valves
Y-Strainers
Pumps
Heat Exchangers
Selection Guides

	Hoffman Specialty® Vacuum Breakers			Hoffman Specialty® Y-Strainers		
	<u>VACUUM BREAKERS</u>	<u>SERIES</u>	<u>PAGE</u>	<u>Y-STRAINERS</u>	<u>SERIES</u>	<u>PAGE</u>
Steam Traps		62 	82	<i>For Steam or Water</i>	400 	96
Regulators						
Vacuum Breakers						
Vents						
Valves						
Y-Strainers						
Pumps						
Heat Exchangers						
Selection Guides						

Technical Information and Selection Guidelines

Reference

Saturated Steam Table	100
Steam Flow Requirement for Heating Water	102
Liquid Weight and Specific Heat Table	102
General Usage Formulas	104
Conversion Factors	104

Steam Traps

Selecting and Sizing Steam Traps.....	105
Steam Trap Selection Guide Chart.....	107
Steam Trap Application Guide.....	108

Series 2000 Pilot Operated Pressure and Temperature Regulators

Operation of Main Valve and Pilots.....	110
Operation of Series 2000 Pilot-Operated Main Valve.....	110
Operation Main Valve with a Spring or Air Pilot.....	111
Operation Main Valve with a Self-Contained Temperature Pilot.....	112
Operation Main Valve with a Combination of Pilots.....	112
Operation Main Valve with Pneumatic Temperature Pilots.....	113
Accuracy of Control – Regulator Steam Capacities.....	114
Selecting and Sizing of Series 2000 Regulators and Pilots.....	115
Typical Application Diagrams	120

Series 1140 & 1141 Temperature Regulators

Selecting and Sizing of Series 1140 and 1141 Temperature Regulators.....	130
--	-----

Steam and Water Vents

Steam Vent Selection Guidelines	131
Water Vent Selection Guidelines	132

Glossary of Terms	134
-------------------------	-----

Date Code Information.....	139
----------------------------	-----

Warranty & Return Policy.....	140
-------------------------------	-----

Float and Thermostatic Steam Traps

Series C, H, I and X

The Series C, H, I and X Float and Thermostatic Traps are designed for commercial and industrial heating applications such as steam main drip traps, unit heaters, tank coils, air

make-up coils, shell and tube heat exchangers, or others that require frequent start ups and continuous modulating loads.

- Maximum operating pressure 175 psi (12.1 bar)
- Maximum capacity 60,000 lb/hr.
- Meets Mil specification WW-T-696-E Type VI, Class 1-5

Series	Maximum Capacity		NPT/BSPT Connection Sizes	Series Features
	lb/hr	kg/hr	in.	
C	60,000	24,240	1 1/4 - 2 1/2	Inlet and outlet in trap cover. High capacity units.
H	9,800	4,450	3/4 - 2	4-Port piping convenience. Cover assembly can be replaced without disturbing piping.
I	2,340	1,062	3/4 - 1 1/4	In-line piping provides maximum return line elevation. Cover assembly can be replaced without disturbing piping.
X	24,000	10,896	2	Inlet and outlet in trap cover. Higher capacity than Series C 2 in.

Float and Thermostatic Steam Traps

Series H **BEAR TRAP**

- Models ¾" - 2" feature Universal 4 - port tapplings, (2 inlets, 2 outlets) that provide versatility to allow easy piping and system monitoring
- Sizes available:
 - ¾" NPT and BSPT
 - 1" NPT and BSPT
 - 1¼" NPT
 - 1½" NPT
 - 2" NPT
- Stainless steel internal components
- Resistant to water hammer and corrosion
- Below condensate level seat design prevents steam leakage
- Rugged thermostatic element eliminates air binding
- Maximum body design pressure
 - 250 psig (17.3 bar) ¾" - 1¼"
 - 175 psig (12.1 bar) 1½" - 2"
- Maximum operating pressure
 - 175 psig (12.1 bar) ¾" - 2"
- Maximum temperature
 - 406°F (208°C) ¾" - 1¼"
 - 377°F (192°C) 1½" - 2"



¾", 1", 1¼"

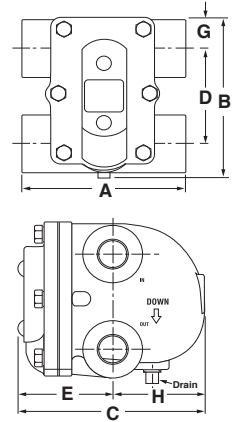

1½", 2"

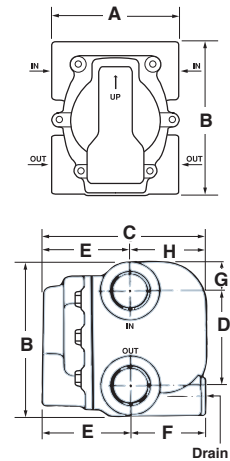

Materials of Construction	
Part	Specifications
Body and cover	Cast Iron 30,000 psi tensile
Valve Pin and Seat	Stainless Steel (Hardened)
Float	Stainless Steel
Lever Assembly	Stainless Steel
Thermostatic Air Vent	Stainless Steel Cage and Thermal Element
Cover Bolts	Grade 5

Dimensions in. (mm)

Size in.	A	B	C	D	E	F	G	H
¾"	5½ (140)	5 ¹⁹ / ₃₂ (142)	6½ (165)	3 ⁵ / ₁₆ (84)	3 ¹³ / ₃₂ (86)	—	1 ⁵ / ₆₄ (27)	3 ¹ / ₁₆ (78)
1"	5½ (140)	5 ¹⁹ / ₃₂ (142)	6½ (165)	3 ⁵ / ₁₆ (84)	3 ¹³ / ₃₂ (86)	—	1 ⁵ / ₆₄ (27)	3 ¹ / ₁₆ (78)
1¼"	5½ (140)	5 ¹⁹ / ₃₂ (142)	6½ (165)	3 (76)	3 ¹³ / ₃₂ (86)	—	1 ⁵ / ₆₄ (27)	3 ¹ / ₁₆ (78)
1½"	6 ³ / ₈ (162)	7 ¹¹ / ₁₆ (195)	8 ⁷ / ₃₂ (209)	5¼ (133)	4 ¹³ / ₃₂ (112)	3 ³ / ₁₆ (97)	1 ¹¹ / ₃₂ (34)	3 ¹³ / ₁₆ (97)
2"	6 (152)	11 (279)	9 ⁵ / ₃₂ (233)	7 ¹⁵ / ₃₂ (190)	4 ¹⁷ / ₃₂ (115)	4 ⁷ / ₃₂ (107)	1 ⁵ / ₈ (41)	4 ⁵ / ₈ (117)

Series H additional inlet and outlet features

Models 3/4" - 2"

- Allows positioning options for easy service
- Additional inlet provides a convenient location for vacuum breakers or separate external air vents. Vacuum breakers are required for systems with a modulating temperature regulating valve. External air vents are required when the trap discharges into a wet return line.
- Additional outlet provides a convenient location for a test valve, which eliminates the need for a costly trap test chamber and electronic monitors.

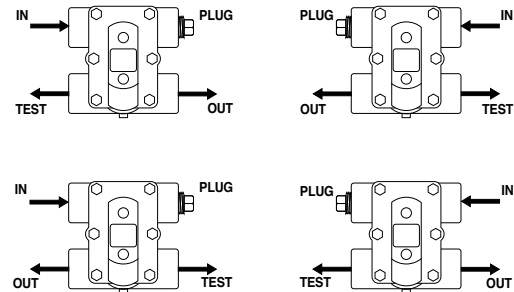

Series H Piping Options

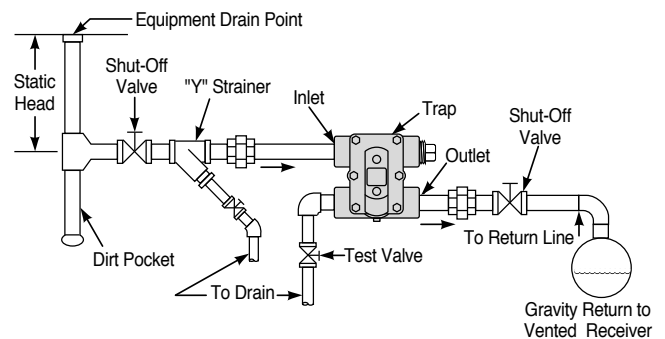

Ordering Information

To convert previously manufactured Hoffman Specialty F & T Trap Model numbers, see page 17.

NPT Model Number	BSPT Model Number	Size in.	NPT Part Number	BSPT Part Number	Seat Differential Pressure Rating psi (bar)	Body Design Pressure Rating psi (bar)	Weight lbs. (kg)
FT015H-3	FT015H-3J	3/4	404200	404201	15 (1)	250 (17.3)	11.7 (5.3)
FT015H-4	FT015H-4J	1	404210	404211	15 (1)	250 (17.3)	11.7 (5.3)
FT015H-5	FT015H-5J	1 1/4	404220	404221	15 (1)	250 (17.3)	11.7 (5.3)
FT015H-6	FT015H-6J	1 1/2	401626	404627	15 (1)	175 (12.1)	22 (10)
FT015H-8	FT015H-8J	2	401629	404630	15 (1)	175 (12.1)	38 (17)
FT030H-3	FT030H-3J	3/4	404202	404203	30 (2.1)	250 (17.3)	11.7 (5.3)
FT030H-4	FT030H-4J	1	404212	404213	30 (2.1)	250 (17.3)	11.7 (5.3)
FT030H-5	FT030H-5J	1 1/4	404222	404223	30 (2.1)	250 (17.3)	11.7 (5.3)
FT030H-6	FT030H-6J	1 1/2	401638	401639	30 (2.1)	175 (12.1)	22 (10)
FT075H-3	FT075H-3J	3/4	404204	404205	75 (5.2)	250 (17.3)	11.7 (5.3)
FT075H-4	FT075H-4J	1	404214	404215	75 (5.2)	250 (17.3)	11.7 (5.3)
FT125H-3	FT125H-3J	3/4	404206	404207	125 (12.1)	250 (17.3)	11.7 (5.3)
FT125H-4	FT125H-4J	1	404216	404217	125 (12.1)	250 (17.3)	11.7 (5.3)
FT175H-3	FT175H-3J	3/4	404208	404209	175 (12.1)	250 (17.3)	11.7 (5.3)
FT175H-4	FT175H-4J	1	404218	404219	175 (12.1)	250 (17.3)	11.7 (5.3)

Float and Thermostatic Steam Traps (continued)

Series H (continued)

- Determine the differential pressure across the trap (inlet pressure - outlet pressure). On applications where the steam is controlled by a modulating temperature regulator, the trap differential should be 1/2 psi (0.34 bar).
- Determine the capacity based on the differential pressure and the required capacity of the trap to open against the maximum inlet steam pressure.
- Apply a Safety Factor by multiplying required capacity by 1.5.

Capacities (Gross Ratings)

Model	Size in.	Orifice Size in. (mm)	Pressure Differential in Pounds Per Square Inch (bar)																	
			1/4 (0.017)	1/2 (0.035)	1 (0.07)	2 (0.14)	5 (0.35)	10 (0.69)	15 (1.0)	20 (1.4)	25 (1.69)	30 (2.1)	40 (2.8)	50 (3.5)	60 (4.2)	75 (5.2)	100 (6.9)	125 (8.6)	150 (10.4)	175 (12.1)
			Capacities in Pounds of Condensate Per Hour (kg/hr.)																	
FT015H-3	3/4	.253 (6.4)	390 (177)	500 (227)	680 (308)	910 (413)	1100 (500)	1450 (658)	1600 (725)											
FT015H-4	1	.253 (6.4)	390 (177)	500 (227)	680 (308)	910 (413)	1100 (500)	1450 (658)	1600 (725)											
FT015H-5	1 1/4	.312 (8)	600 (272)	770 (350)	980 (444)	1240 (562)	1640 (744)	2000 (907)	2340 (1062)											
FT015H-6	1 1/2	.500 (13)	1280 (581)	1700 (771)	2050 (930)	2550 (1157)	3500 (1588)	4400 (1996)	5300 (2404)											
FT015H-8	2	.687 (17)	2500 (1134)	3150 (1429)	4000 (1814)	5000 (2268)	6800 (3084)	8300 (3765)	9800 (4405)											
FT030H-3	3/4	.235 (6)	380 (172)	470 (214)	630 (285)	870 (395)	1050 (475)	1380 (625)	1530 (695)	1700 (770)	1820 (825)	1900 (860)								
FT030H-4	1	.235 (6)	380 (172)	470 (214)	630 (285)	870 (395)	1050 (475)	1380 (625)	1530 (695)	1700 (770)	1820 (825)	1900 (860)								
FT030H-5	1 1/4	.253 (6.4)	420 (190)	550 (250)	740 (335)	1000 (450)	1200 (545)	1550 (700)	1760 (800)	1850 (840)	2000 (907)	2200 (1000)								
FT030H-6	1 1/2	.438 (11)	580 (263)	800 (362)	1200 (544)	1680 (762)	2600 (1179)	3500 (1387)	4500 (2041)	5200 (2358)	5700 (2585)	6100 (2766)								
FT075H-3	3/4	.166 (4.2)	160 (72)	210 (95)	280 (125)	360 (165)	520 (235)	700 (320)	800 (360)	870 (395)	930 (420)	970 (440)	1120 (510)	1230 (560)	1300 (590)	1450 (658)				
FT075H-4	1	.166 (4.2)	160 (72)	210 (95)	280 (125)	360 (165)	520 (235)	700 (320)	800 (360)	870 (395)	930 (420)	970 (440)	1120 (510)	1230 (560)	1300 (590)	1450 (658)				
FT125H-3	3/4	.125 (3.2)	100 (45)	130 (60)	170 (77)	230 (104)	330 (150)	410 (186)	500 (225)	560 (255)	620 (280)	660 (300)	750 (340)	830 (375)	890 (400)	970 (440)	1100 (500)	1190 (540)		
FT125H-4	1	.125 (3.2)	100 (45)	130 (60)	170 (77)	230 (104)	330 (150)	410 (186)	500 (225)	560 (255)	620 (280)	660 (300)	750 (340)	830 (375)	890 (400)	970 (440)	1100 (500)	1190 (540)		
FT175H-3	3/4	.106 (2.7)	70 (32)	80 (36)	110 (50)	140 (63)	220 (100)	280 (127)	340 (155)	380 (172)	400 (180)	420 (190)	460 (210)	480 (220)	520 (235)	580 (263)	690 (315)	850 (385)	960 (435)	1000 (454)
FT175H-4	1	.106 (2.7)	70 (32)	80 (36)	110 (50)	140 (63)	220 (100)	280 (127)	340 (155)	380 (172)	400 (180)	420 (190)	460 (210)	480 (220)	520 (235)	580 (263)	690 (315)	850 (385)	960 (435)	1000 (454)

Series H Competitive Dimensional Comparison of Distance Between Inlet and Outlet Pipes

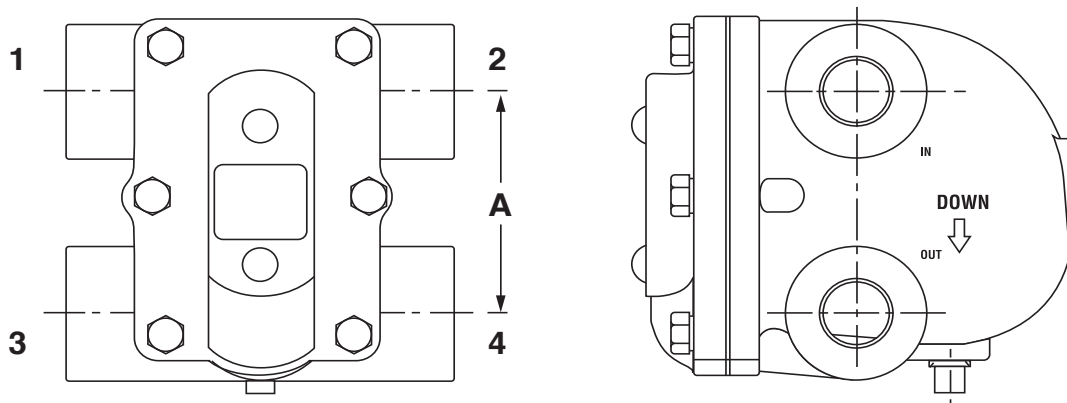

Dimensions in. (mm)

Size	Manufacturer	Port Tappings				A in. (mm)
		1	2	3	4	
3/4" and 1"	Hoffman FT015H-3 / FT015H-4	Yes	Yes	Yes	Yes	3 ⁵ / ₁₆ (83)
	Hoffman 55	Yes	Yes	Yes	Yes	3 ¹ / ₈ (78)
	Spirax FT015	No	Yes	No	Yes	3 ⁵ / ₁₆ (83)
	Armstrong 15-B3 & 15-B4	Yes	Yes	No	Yes	3 (76)
	Mepco/Dunham Bush 40-215 & 40-415	No	Yes	No	Yes	3 ³ / ₈ (86)
	Mepco/Dunham Bush 40-215 & 40-415	Yes	Yes	Yes	Yes	3 ³ / ₈ (86)

Size	Manufacturer	Port Tappings				A in. (mm)
		1	2	3	4	
1 1/4"	Hoffman FT015H-5	Yes	Yes	Yes	Yes	3 (76)
	Hoffman 55	Yes	Yes	Yes	Yes	4 ¹ / ₈ (104)
	Spirax FT015	No	Yes	No	Yes	3 (76)
	Armstrong 15-B5	Yes	Yes	No	Yes	3 (76)
	Mepco/Dunham Bush 40-515	No	Yes	No	Yes	3 (76)
	Mepco/Dunham Bush 44-515	Yes	Yes	Yes	Yes	3 (76)

Size	Manufacturer	Port Tappings				A in. (mm)
		1	2	3	4	
1 1/2"	Hoffman FT015H-6	Yes	Yes	Yes	Yes	5 ¹ / ₄ (133)
	Hoffman 55	Yes	Yes	Yes	Yes	5 ¹ / ₄ (133)
	Armstrong 15-B6	Yes	Yes	No	Yes	4 ³ / ₁₆ (106)
	Mepco/Dunham Bush 40-715	No	Yes	No	Yes	3 (76)
	Mepco/Dunham Bush 44-715	Yes	Yes	Yes	Yes	3 (76)

Size	Manufacturer	Port Tappings				A in. (mm)
		1	2	3	4	
2"	Hoffman FT015H-8	Yes	Yes	Yes	Yes	7 ¹⁵ / ₃₂ (190)
	Hoffman 55	Yes	Yes	Yes	Yes	7 ¹⁵ / ₃₂ (190)
	Armstrong 15-B8	Yes	Yes	No	Yes	6 (152)

Float and Thermostatic Steam Traps (continued)

Series I In-line

- In-line piping design provides complete drainage while minimizing vertical height change
- Ideal for overhead applications
- For commercial and industrial applications such as air make-up coils, cooking kettles and unit heaters
- Sizes available:
 - ¾" NPT and BSPT
 - 1" NPT and BSPT
 - 1¼" NPT and BSPT
- Below condensate level seat design prevents steam leakage
- Stainless steel internal components
- Rugged thermostatic element eliminates air binding
- Resistant to water hammer and corrosion
- Maximum design pressure 250 psig (17.3 bar)
- Maximum operating pressure 175 psig (12.1 bar)
- Maximum temperature 406°F (208°C)

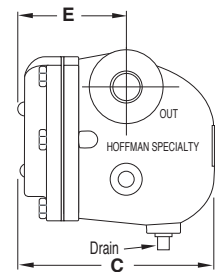
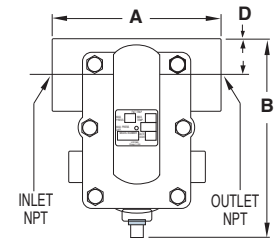

Materials of Construction	
Part	Specifications
Body and cover	Cast Iron 30,000 psi tensile
Valve Pin and Seat	Stainless Steel (Hardened)
Float	Stainless Steel
Lever Assembly	Stainless Steel
Thermostatic Air Vent	Stainless Steel Cage and Thermal Element
Cover Bolts	Grade 5

Dimensions in. (mm)

Size in.	A	B	C	D	E
¾					
1	5½ (140)	6 ⁹ / ₁₆ (167)	6 ⁵ / ₈ (168)	1 ³ / ₁₆ (30)	3½ (89)
1¼					

Series I In-line BEARTRAP® (continued)

- Determine the differential pressure across the trap (inlet pressure - outlet pressure). On applications where the steam is controlled by a modulating temperature regulator, the trap differential should be 1/2 psi (0.34 bar).
- Determine the capacity based on the differential pressure and the required capacity of the trap to open against the maximum inlet steam pressure.
- Apply a Safety Factor by multiplying required capacity by 1.5.

Capacities (Gross Ratings)

Model	Size in.	Orifice Size in. (mm)	Pressure Differential in Pounds Per Square Inch (bar)																	
			1/4 (0.017)	1/2 (0.035)	1 (0.07)	2 (0.14)	5 (0.35)	10 (0.69)	15 (1.0)	20 (1.4)	25 (1.69)	30 (2.1)	40 (2.8)	50 (3.5)	60 (4.2)	75 (5.2)	100 (6.9)	125 (8.6)	150 (10.4)	175 (12.1)
Capacities in Pounds of Condensate Per Hour (kg/hr.)																				
FT015I-3 FT015I-4	3/4, 1	.253 (6.4)	390 (177)	500 (227)	680 (308)	910 (413)	1100 (500)	1450 (658)	1600 (725)											
FT015I-5	1 1/4	.312 (8)	600 (272)	770 (350)	980 (444)	1240 (562)	1640 (744)	2000 (907)	2340 (1062)											
FT030I-3 FT030I-4	3/4, 1	.235 (6)	380 (172)	470 (214)	630 (285)	870 (395)	1050 (475)	1380 (625)	1530 (695)	1700 (770)	1820 (825)	1900 (860)								
FT030I-5	1 1/4	.253 (6.4)	420 (190)	550 (250)	740 (335)	1000 (450)	1200 (545)	1550 (700)	1760 (800)	1850 (840)	2000 (907)	2200 (1000)								
FT075I-3 FT075I-4	3/4, 1	.166 (4.2)	160 (72)	210 (95)	280 (125)	360 (165)	520 (235)	700 (320)	800 (360)	870 (395)	930 (420)	970 (440)	1120 (510)	1230 (560)	1300 (590)	1450 (658)				
FT075I-5	1 1/4	.166 (4.2)	160 (72)	210 (95)	280 (125)	360 (165)	520 (235)	700 (320)	800 (360)	870 (395)	930 (420)	970 (440)	1120 (510)	1230 (560)	1300 (590)	1450 (658)				
FT125I-3 FT125I-4	3/4, 1	.125 (3.2)	100 (45)	130 (60)	170 (77)	230 (104)	330 (150)	410 (186)	500 (225)	560 (255)	620 (280)	660 (300)	750 (340)	830 (375)	890 (400)	970 (440)	1100 (500)	1190 (540)		
FT125I-5	1 1/4	.125 (3.2)	100 (45)	130 (60)	170 (77)	230 (104)	330 (150)	410 (186)	500 (225)	560 (255)	620 (280)	660 (300)	750 (340)	830 (375)	890 (400)	970 (440)	1100 (500)	1190 (540)		
FT175I-3 FT175I-4	3/4, 1	.106 (2.7)	70 (32)	80 (36)	110 (50)	140 (63)	220 (100)	280 (127)	340 (155)	380 (172)	400 (180)	420 (190)	460 (210)	480 (220)	520 (235)	580 (263)	690 (315)	850 (385)	960 (435)	1000 (454)
FT175I-5	1 1/4	.106 (2.7)	70 (32)	80 (36)	110 (50)	140 (63)	220 (100)	280 (127)	340 (155)	380 (172)	400 (180)	420 (190)	460 (210)	480 (220)	520 (235)	580 (263)	690 (315)	850 (385)	960 (435)	1000 (454)

Ordering Information

NPT Model Number	BSPT Model Number	Size in.	NPT Part Number	BSPT Part Number	Seat Differential Pressure Rating psi (bar)	Body Design Pressure Rating psi (bar)	Weight lbs. (kg)
FT015I-3	FT015I-3J	3/4	404270	404285	15 (1.0)	250 (17.3)	11.7 (5.3)
FT015I-4	FT015I-4J	1	404271	404286	15 (1.0)	250 (17.3)	11.7 (5.3)
FT015I-5	FT015I-5J	1 1/4	404272	404287	15 (1.0)	250 (17.3)	11.7 (5.3)
FT030I-3	FT030I-3J	3/4	404273	404288	30 (2.1)	250 (17.3)	11.7 (5.3)
FT030I-4	FT030I-4J	1	404274	404289	30 (2.1)	250 (17.3)	11.7 (5.3)
FT030I-5	FT030I-5J	1 1/4	404275	404290	30 (2.1)	250 (17.3)	11.7 (5.3)
FT075I-3	FT075I-3J	3/4	404276	404291	75 (5.2)	250 (17.3)	11.7 (5.3)
FT075I-4	FT075I-4J	1	404277	404292	75 (5.2)	250 (17.3)	11.7 (5.3)
FT075I-5	FT075I-5J	1 1/4	404278	404293	75 (5.2)	250 (17.3)	11.7 (5.3)
FT125I-3	FT125I-3J	3/4	404279	404294	125 (8.6)	250 (17.3)	11.7 (5.3)
FT125I-4	FT125I-4J	1	404280	404295	125 (8.6)	250 (17.3)	11.7 (5.3)
FT125I-5	FT125I-5J	1 1/4	404281	404296	125 (8.6)	250 (17.3)	11.7 (5.3)
FT175I-3	FT175I-3J	3/4	404282	404297	175 (12.1)	250 (17.3)	11.7 (5.3)
FT175I-4	FT175I-4J	1	404283	404298	175 (12.1)	250 (17.3)	11.7 (5.3)
FT175I-5	FT175I-5J	1 1/4	404284	404299	175 (12.1)	250 (17.3)	11.7 (5.3)

Float and Thermostatic Steam Traps (continued)

Series C and X **BEAR TRAP®**

- For large high capacity units

- Sizes available:

Series C:

1 1/4" NPT and BSPT

1 1/2" NPT and BSPT

2" NPT and BSPT

2 1/2" NPT

Series X:

2" NPT

- Resistant to water hammer and corrosion
- Below condensate level seat design prevents steam leakage
- Rugged stainless steel thermostatic element eliminates air binding
- Stainless steel internal components
- Can be serviced without dismantling piping
- Maximum operating pressure 175 psig (12.1 bar)
- Maximum temperature 377°F (192°C)



Series C
1 1/4" & 1 1/2"

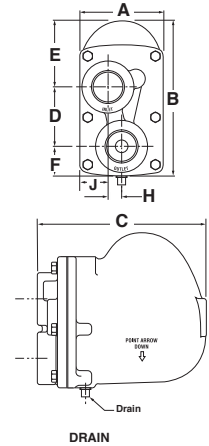

Series C
2"

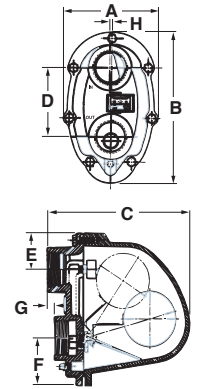

Series X
2"

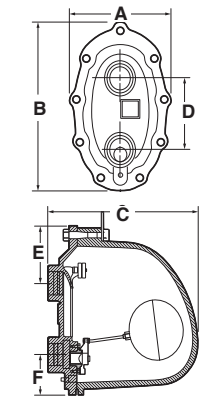

Series C
2 1/2"

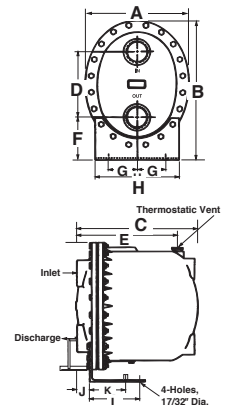

Materials of Construction	
Part	Specifications
Body and cover	Cast Iron 30,000 psi tensile
Valve Pin and Seat	Stainless Steel (Hardened)
Float	Stainless Steel
Lever Assembly	Stainless Steel
Thermostatic Air Vent	Stainless Steel Cage and Thermal Element
Cover Bolts	Grade 5
Baffle	Stainless Steel {2 1/2" units only}

Dimensions in. (mm)

Size in.	A	B	C	D	E
1 1/4	4 1/4 (108)	8 5/16 (211)	8 9/16 (217)	3 (76)	3 3/8 (86)
1 1/2	4 1/4 (108)	8 5/16 (211)	8 9/16 (217)	3 (76)	3 3/8 (86)
2-Std.	7 3/16 (183)	10 1/8 (257)	10 1/2 (267)	4 15/16 (379)	2 11/16 (68)
2-X	10 (254)	15 (381)	15 1/2 (394)	6 5/8 (168)	4 3/4 (121)
2 1/2	14 1/2 (368)	20 1/4 (514)	17 3/8 (441)	9 1/2 (241)	14 15/16 (379)

Size in.	F	G	H	J	K	L
1 1/4	2 (51)	—	45/64 (17.8)	1 3/8 (35)	—	—
1 1/2	2 (51)	—	45/64 (17.8)	1 3/8 (35)	—	—
2-Std.	3 1/4 (83)	1 1/2 (12.7)	1/8 (3.2)	—	—	—
2-X	3 1/2 (89)	—	—	—	—	—
2 1/2	6 1/4 (159)	5 (127)	12 (305)	1 5/8 (41)	4 1/2 (114)	7 (178)

Ordering Information

To convert previously manufactured Hoffman Specialty F & T Trap Model numbers, see page 17.

NPT Model Number*	BSPT Model Number	Size in.	NPT Part Number	BSPT Part Number	Seat Differential Pressure psi (bar)	Body Design Pressure Rating psi (bar)	Weight lbs. (kg)
FT015C-6	FT015C-6J	1½	404230	404231	15 (1.0)	175 (12.1)	18 (8)
FT015C-8	FT015C-8J	2	404240	404241	15 (1.0)	175 (12.1)	33 (15)
FT015X-8	FT015X-8J	2	404242	404243	15 (1.0)	175 (12.1)	108 (49)
FT015C-10	FT015C-10J	2½	404244	404245	15 (1.0)	175 (12.1)	175 (79)
FT030C-6	FT030C-6J	1½	404232	404233	30 (2.1)	175 (12.1)	18 (8)
FT030C-8	FT030C-8J	2	401887	401888	30 (2.1)	175 (12.1)	33 (15)
FT030X-8	FT030X-8J	2	401899	401910	30 (2.1)	175 (12.1)	108 (49)
FT030C-10	FT030C-10J	2½	401875	401921	30 (2.1)	175 (12.1)	175 (79)
FT075C-5	FT075C-5J	1¼	404224	404225	75 (5.2)	175 (12.1)	18 (8)
FT075C-6	FT075C-6J	1½	404234	404235	75 (5.2)	175 (12.1)	18 (8)
FT075C-8	FT075C-8J	2	401890	401891	75 (5.2)	175 (12.1)	33 (15)
FT075X-8	FT075X-8J	2	401902	401912	75 (5.2)	175 (12.1)	108 (49)
FT075C-10	FT075C-10J	2½	401875	401913	75 (5.2)	175 (12.1)	175 (79)
FT125C-5	FT125C-5J	1¼	404226	404227	125 (12.1)	175 (12.1)	18 (8)
FT125C-6	FT125C-6J	1½	404236	404237	125 (12.1)	175 (12.1)	18 (8)
FT125C-8	FT125C-8J	2	401893	401894	125 (12.1)	175 (12.1)	33 (15)
FT125X-8	FT125X-8J	2	401905	401922	125 (12.1)	175 (12.1)	108 (49)
FT125C-10	FT125C-10J	2½	401881	401924	125 (12.1)	175 (12.2)	175 (79)
FT175C-5	FT175C-5J	1¼	404228	401915	175 (12.1)	175 (12.1)	18 (8)
FT175C-6	FT175C-6J	1½	404238	401916	175 (12.1)	175 (12.1)	18 (8)
FT175C-8	FT175C-8J	2	401896	401925	175 (12.1)	175 (12.1)	33 (15)
FT175X-8	FT175X-8J	2	401907	401918	175 (12.1)	175 (12.1)	105 (49)
FT175C-10	FT175C-10J	2½	401884	401919	175 (12.1)	175 (12.1)	175 (79)

Note: "J" suffix at end of Model Number indicates BSPT threads, i.e. FT075C-8J

Series C and X Competitive Dimensional Comparison of Distance Between Inlet and Outlet Pipes of Traps with Tappings in the Cover

Dimensions in. (mm)

Size	Manufacturer/Model	A	B
1½"	Hoffman FT015C-6	3 (76)	23/32 (18)
	Spirax FT15	3 (76)	23/32 (18)
2"	Hoffman FT015C-8	4 ¹⁵ / ₁₆ (124)	1/8 (3)
	Mepco/Dunham Bush 30-8A	5 ³ / ₈ (136)	1½ (38)
	Spirax FT15	4 ¹⁵ / ₁₆ (124)	1/8 (38)
2"	Hoffman FT015X-8	6 ⁵ / ₈ (168)	0
	Armstrong 15-J8	6 ⁵ / ₈ (168)	0
	Mepco/Dunham Bush SA30-815	6 ⁷ / ₈ (175)	1 ³ / ₈ (35)
	Spirax FTB-20	4½ (114)	1/2 (13)
2½"	Hoffman FT015C-10	9½ (241)	0
	Armstrong 30-L10	11 ⁵ / ₁₆ (287)	0
	Mepco/Dunham Bush SA30-930A	5¼ (133)	1½ (38)
	Spirax FTB-125	7¼ (184)	1 ⁷ / ₁₆ (36)

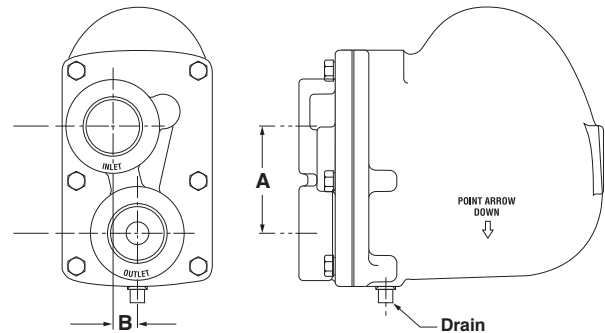

Float and Thermostatic Steam Traps (continued)

Capacities (Series C and X)

- Determine the differential pressure across the trap (inlet pressure - outlet pressure). On applications where the steam is controlled by a modulating temperature regulator, the trap differential should be 1/2 psi (0.34 bar).
- Determine the capacity based on the differential pressure and the required capacity of the trap to open against the maximum inlet steam pressure.
- Apply a Safety Factor by multiplying required capacity by 1.5.

Capacities (Gross Ratings)

Model	Size in.	Orifice Size in. (mm)	Pressure Differential in Pounds Per Square Inch (bar)																	
			1/4 (0.017)	1/2 (0.035)	1 (0.07)	2 (0.14)	5 (0.35)	10 (0.69)	15 (1.0)	20 (1.4)	25 (1.69)	30 (2.1)	40 (2.8)	50 (3.5)	60 (4.2)	75 (5.2)	100 (6.9)	125 (8.6)	150 (10.4)	175 (12.1)
			Capacities in Pounds of Condensate Per Hour (kg/hr.)																	
FT015C-6	1 1/2	.5 (12.7)	1100 (500)	1700 (770)	2400 (1090)	3300 (1500)	5000 (2270)	6600 (3000)	7600 (3450)											
FT015C-8	2	.687 (17.4)	2300 (1043)	2800 (1270)	3600 (1630)	4650 (2110)	6900 (3130)	9000 (4080)	10,900 (4948)											
FT015X-8	2	.970 (24.6)	6500 (2950)	8000 (3628)	9500 (4310)	10,800 (4900)	15,500 (7030)	20,900 (9480)	24,000 (10,885)											
FT015C-10	2 1/2	1.875 (47.6)	17,000 (7710)	20,000 (9070)	27,000 (12,250)	36,000 (16,330)	46,000 (20,865)	55,000 (24,950)	60,000 (27,210)											
FT030C-6	1 1/2	.390 (10)	1000 (450)	1300 (590)	1700 (770)	2300 (1040)	3400 (1540)	4600 (2085)	5500 (2495)	6000 (2720)	6600 (2995)	7000 (3178)								
FT030C-8	2	.563 (14)	1700 (771)	2500 (1134)	3100 (1406)	4100 (1859)	5800 (2630)	7650 (3470)	9000 (4082)	10,200 (4626)	11,100 (5034)	12,000 (5443)								
FT030X-8	2	.876 (22)	3400 (1543)	4600 (2088)	6400 (2905)	8400 (3813)	12,500 (5675)	16,900 (7672)	19,000 (8626)	21,500 (9761)	23,500 (10,669)	24,000 (10,896)								
FT030C-10	2 1/2	1.625 (41)	14,000 (6356)	17,000 (7718)	20,900 (9488)	25,500 (11,577)	33,200 (15,072)	40,500 (18,387)	45,500 (20,657)	49,400 (22,427)	52,700 (23,925)	55,600 (25,242)								
FT075C-5	1 1/4	.312 (8)	600 (272)	800 (363)	1040 (470)	1410 (640)	2200 (1000)	3100 (1405)	3800 (1725)	4100 (1860)	4500 (2040)	4700 (2130)	5000 (2270)	5300 (2400)	5500 (2500)	5900 (2675)				
FT075C-6	1 1/2	.312 (8)	600 (272)	800 (363)	1040 (470)	1410 (640)	2200 (1000)	3100 (1405)	3800 (1725)	4100 (1860)	4500 (2040)	4700 (2130)	5000 (2270)	5300 (2400)	5500 (2500)	5900 (2675)				
FT075C-8	2	.390 (10)	1000 (453)	1350 (612)	1700 (771)	2150 (975)	2950 (1338)	3600 (1632)	4300 (1950)	4850 (2199)	5400 (2449)	5800 (2630)	6600 (2993)	7200 (3265)	7850 (3560)	8500 (3855)				
FT075X-8	2	.585 (15)	2550 (1156)	3150 (1428)	4300 (1930)	5450 (2472)	7600 (3447)	10,400 (4717)	11,400 (5171)	12,500 (5670)	13,500 (6123)	14,250 (6463)	15,600 (7076)	17,150 (7779)	18,600 (8436)	20,500 (9298)				
FT075C-10	2 1/2	1.031 (26)	5900 (2676)	7700 (3492)	10,000 (4536)	13,000 (5896)	18,600 (8436)	24,200 (10,977)	28,300 (12,836)	31,600 (14,333)	34,400 (15,603)	36,800 (16,692)	41,100 (18,642)	44,800 (20,321)	48,040 (21,790)	52,300 (23,723)				
FT125C-5	1 1/4	.246 (6.2)	430 (195)	540 (245)	700 (320)	940 (425)	1400 (635)	1800 (820)	2200 (1000)	2350 (1065)	2600 (1180)	2800 (1270)	3150 (1430)	3400 (1540)	3500 (1590)	3850 (1750)	4400 (2000)	4800 (2180)		
FT125C-6	1 1/2	.246 (6.2)	430 (195)	540 (245)	700 (320)	940 (425)	1400 (635)	1800 (820)	2200 (1000)	2350 (1065)	2600 (1180)	2800 (1270)	3150 (1430)	3400 (1540)	3500 (1590)	3850 (1750)	4400 (2000)	4800 (2180)		
FT125C-8	2	.294 (7)	730 (331)	900 (408)	1180 (535)	1450 (657)	2000 (907)	2600 (1179)	3100 (1406)	3550 (1610)	3900 (1769)	4250 (1927)	4850 (2199)	5350 (2426)	5850 (2653)	6450 (2925)	7350 (3333)	8150 (3696)		
FT125X-8	2	.448 (11)	2300 (1043)	2800 (1270)	3450 (1564)	4200 (1905)	5450 (2472)	6600 (2993)	7450 (3379)	8050 (3651)	8600 (3900)	8950 (4059)	10,350 (4694)	11,950 (5420)	13,400 (6078)	15,600 (7076)	18,850 (8550)	21,800 (9888)		
FT125C-10	2 1/2	.797 (20)	4000 (1814)	5300 (2404)	6900 (3129)	9100 (4127)	13,000 (5896)	17,100 (7756)	20,000 (9072)	22,400 (10,160)	24,500 (11,113)	26,300 (11,929)	29,400 (13,335)	32,100 (14,560)	34,650 (15,717)	37,600 (17,055)	42,100 (19,096)	46,000 (20,865)		
FT175C-5	1 1/4	.210 (5.3)	260 (120)	350 (160)	480 (220)	640 (290)	940 (425)	1190 (540)	1450 (660)	1560 (710)	1670 (760)	1750 (790)	1910 (865)	2040 (925)	2100 (950)	2300 (1040)	2500 (1135)	2900 (1315)	3140 (1425)	3240 (1470)
FT175C-6	1 1/2	.210 (5.3)	260 (120)	350 (160)	480 (220)	640 (290)	940 (425)	1190 (540)	1450 (660)	1560 (710)	1670 (760)	1750 (790)	1910 (865)	2040 (925)	2100 (950)	2300 (1040)	2500 (1135)	2900 (1315)	3140 (1425)	3240 (1470)
FT175C-8	2	.244 (6)	520 (235)	660 (299)	820 (371)	1050 (476)	1450 (657)	1850 (839)	2250 (1020)	2600 (1179)	2900 (1315)	3100 (1406)	3600 (1632)	4050 (1837)	4400 (1995)	4800 (2177)	5600 (2540)	6250 (2835)	6800 (3084)	7500 (3402)
FT175X-8	2	.375 (10)	2100 (953)	2600 (1180)	3000 (1362)	3500 (1589)	4400 (1997)	4900 (2224)	5350 (2428)	5800 (2633)	6250 (2837)	6700 (3041)	7600 (3450)	8600 (3904)	9550 (4335)	11,000 (4994)	13,000 (5902)	14,750 (6696)	16,500 (7491)	18,000 (8172)
FT175C-10	2 1/2	.688 (17)	2460 (1116)	3350 (1520)	4600 (2088)	6200 (2814)	9400 (4267)	12,800 (5811)	15,400 (6991)	17,500 (7945)	19,300 (8762)	21,000 (9534)	23,800 (10,805)	26,300 (11,940)	28,060 (12,739)	31,600 (14,346)	35,900 (16,298)	39,700 (18,023)	43,100 (19,567)	46,200 (20,974)

Conversion of Previously Manufactured Hoffman Specialty Models to Current Model Numbers

Previously Manufactured			Current Model		
Model No.	NPT Size in.	Part Number	Model No.	NPT Size in.	Part Number
55	3/4	401617	FT015H-3	3/4	404200
55	1	401620	FT015H-4	1	404210
55	1 1/4	401623	FT015H-5	1 1/4	404220
55	1 1/2	401626	FT015H-6	1 1/2	401626
55	2	401629	FT015H-8	2	401629
None	—	—	FT015C-6	1 1/2	404230
None	—	—	FT015C-8	2	404240
None	—	—	FT015X-8	2	404242
None	—	—	FT015C-10	2 1/2	404244
550	1	401632	FT030H-4	1	404212
550	1 1/4	401635	FT030H-5	1 1/4	404222
550	1 1/2	401638	FT030H-6	1 1/2	401638
550	2	401887	FT030C-8	2	401887
551	1	401641	FT075H-4	1	404214
551	1 1/4	401644	FT075C-5	1 1/4	404224
551	1 1/2	401647	FT075C-6	1 1/2	404234
551	2	401890	FT075C-8	2	401890
552	1	401650	FT125H-4	1	404216
552	1 1/4	401653	FT125C-5	1 1/4	404226
552	1 1/2	401656	FT125C-6	1 1/2	404236
552	2	401893	FT125C-8	2	401893
553	1	401659	FT175H-4	1	404218
553	1 1/4	401662	FT175C-5	1 1/4	404228
553	1 1/2	401665	FT175C-6	1 1/2	404238
553	2	401896	FT175C-8	2	401896
590	3/4	401668	FT030H-3	3/4	404202
590	1	401671	FT030H-4	1	404212
590	1 1/2	401674	FT030C-6	1 1/2	404232
590	2	401899	FT030X-8	2	401899
590	2 1/2	401875	FT030C-10	2 1/2	401875
591	3/4	401677	FT075H-3	3/4	404204
591	1	401680	FT075H-4	1	404214
591	1 1/2	401683	FT075C-6	1 1/2	404234
591	2	401902	FT075X-8	2	401902
591	2 1/2	401878	FT075C-10	2 1/2	401878
592	3/4	401686	FT125H-3	3/4	404206
592	1	401689	FT125H-4	1	404216
592	1 1/2	401692	FT125C-6	1 1/2	404236
592	2	401905	FT125X-8	2	401905
592	2 1/2	401881	FT125C-10	2 1/2	401881
593	3/4	401695	FT175H-3	3/4	404208
593	1	401698	FT175H-4	1	404218
593	1 1/4	401701	FT175C-5	1 1/4	404228
593	2	401907	FT175X-8	2	401907
593	2 1/2	401884	FT175C-10	2 1/2	401884

Current Model number designation code example:

Model	Seat Pressure	Series	Size
FT	015	H	3

There are dimensional differences between some current models as compared to previous models. Please refer to dimensional diagrams for each trap.

Float and Thermostatic Steam Traps (continued)

Cover Assemblies for Spirax Sarco Float & Thermostatic Steam Traps

Spirax Sarco F&T Trap Model Number	Pressure psi (bar)	Size in.	Hoffman Specialty Cover Assembly* Part Number
FT15	15 (1.1)	3/4	604001
		1	604001
		1 1/4	604006
		1 1/2	604011
FT30	30 (2.1)	3/4	604002
		1	604002
		1 1/4	604007
		1 1/2	604012
FT75	75 (5.3)	3/4	604003
		1	604003
		1 1/4	604008
		1 1/2	604013
FT125	125 (8.8)	3/4	604004
		1	604004
		1 1/4	604009
		1 1/2	604014

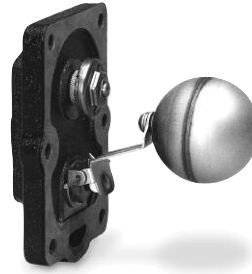

Cover Assembly

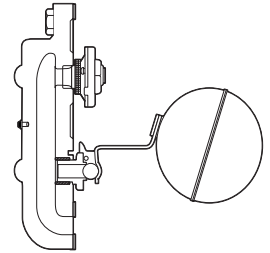

* Cover assembly includes cover casting, all internal components, and cover gasket.

Thermostatic Steam Traps Series 17C Balanced Pressure



The Series 17C Balanced Pressure Thermostatic Steam Traps are for institutional, commercial and residential heating system applications such as schools, hospitals, apartment buildings, homes or others where low or moderate water hammer may occur.

- Subcooling for extremely efficient system operation and elimination of flash steam losses on low pressure systems
- Sizes available:
 - 1/2" NPT and BSPT Angle, Vertical
 - 1/2" NPT Swivel
 - 3/4" NPT and BSPT Angle, Vertical
 - 1" NPT and BSPT Angle
- Replaceable Dura-Stat® module
- 3-Year Warranty
- Meets Mil specification A-A-60001 Type V, Style A, Class 1 and 2
- Stainless steel components
- Resistant to moderate water hammer and chemical attack
- Maximum operating pressure 25 psig (1.7 bar)



**Model 17C Angle
(with short nipple)**
1/2"

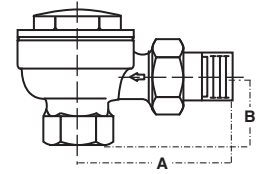

Model 17C Angle
1/2"

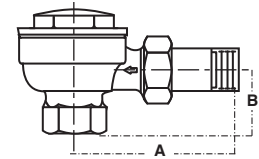

Model 17C Angle
3/4"

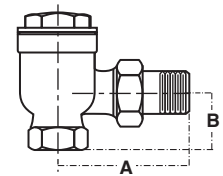

Model 17C Angle
1"

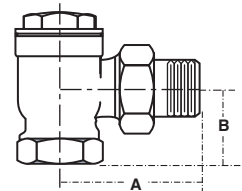

Model 17C Vertical
1/2"

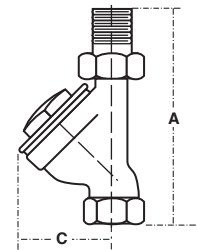

Model 17C Swivel
1/2"

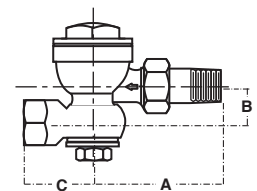

Model 17C Straightaway
3/4"

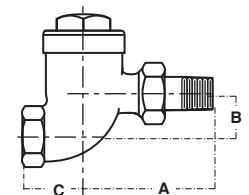

Series 17C Balanced Pressure 
Dimensions, in. (mm)

Model	Pattern	Size in.	A	B	C
17C-AS-2-25	Angle (w/short Nipple)	½	2 ²⁷ / ₃₂ (72)	1¼ (32)	—
17C-A-2-25	Angle	½	3¼ (83)	1¼ (32)	—
17C-V-2-25	Vertical	½	4 ²³ / ₃₂ (120)	—	2⅛ (54)
17C-SV-2-25	Swivel	½	3¼ (83)	1 ¹⁵ / ₁₆ (24)	1 ¹³ / ₁₆ (46)
17C-A-3-25	Angle	¾	3⅛ (79)	1½ (38)	—
17C-S-3-25	Straightaway	¾	3 ⁵ / ₃₂ (80)	1⅛ (29)	1 ⁵ / ₈ (41)
17C-A-4-25	Angle	1	3 ⁷ / ₃₂ (82)	1¾ (45)	—

Gross Ratings

Series 17C	Differential Across Trap psi (bar)								
	¼ (.017)	½ (.034)	1 (.069)	1½ (.10)	2 (.14)	5 (.35)	10 (.7)	15 (1.0)	25 (1.7)
	Capacity lb/hr (kg/hr)								
	42 (19)	51 (23)	63 (29)	72 (33)	77 (35)	102 (46)	125 (57)	140 (64)	162 (73)

Series 17C capacities are based on 40° F (22°C) subcooling. Cold capacity is approximately 4 times capacity shown.

SHEMA

Series 17C	Differential Across Trap psi								
	¼	½	1	1½	2	5	10	15	25
	Capacity sq. ft. EDR*								
	85	120	165	200	235	370	530	640	800

* Ratings are in accordance with recommended standards established by the Steam Heating Equipment Manufacturers association (SHEMA).

1 sq. ft. EDR is equivalent to a heat emission of 240 BTU per hour with 2 psig steam filling a radiator surrounded by 70°F ambient air.

To convert sq. ft. EDR to lbs. of condensate, or steam per hour, divide the sq. ft. rating by 4.

Ordering Information

NPT Model Number	BSPT Model Number	Size in.	NPT Part Number	BSPT Part Number	Differential Pressure Rating psi (bar)	Weight lbs. (kg)
17C-AS-2-25 Angle (w/short nipple)		½	401542		25 (1.7)	1.2 (.54)
17C-A-2-25 Angle		½	401536		25 (1.7)	1.2 (.54)
17C-V-2-25 Vertical		½	401551		25 (1.7)	1.2 (.54)
17C-SV-2-25 Swivel		½	401545		25 (1.7)	1.2 (.54)
17C-A-3-25 Angle	17C-A-3J-25 Angle	¾	402006	402014	25 (1.7)	1.5 (.7)
17C-S-3-25 Straightaway		¾	402011		25 (1.7)	1.3 (.6)
17C-A-4-25 Angle		1	402012		25 (1.7)	2.3 (1)

Thermostatic Steam Traps (continued)

Series 8C Balanced Pressure

The Series 8C Balanced Pressure Thermostatic Steam Traps are for institutional and commercial heating system applications or others that require high capacity operation.

- Sizes available:
 - 1/2" NPT and BSPT Angle
 - 3/4" NPT and BSPT Angle or Straightaway
- Subcooling for extremely efficient system operation and elimination of flash steam losses on low pressure systems
- Replaceable Dura-Stat® module
- 3-Year Warranty
- Meets Mil specification A-A-60001 Type V, Style A, Class 1 - 4
- Stainless steel components
- Resistant to moderate water hammer and chemical attack
- Maximum operating pressure 125 psig (8.6 bar)



Model 8C Angle
1/2"

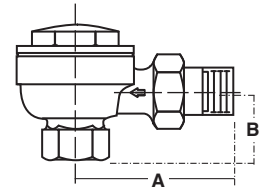

Model 8C Angle
3/4"

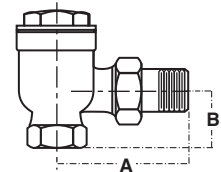

Model 8C Straightaway
3/4"

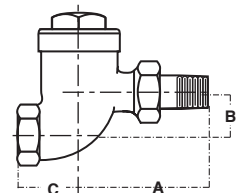

Dimensions, in. (mm)

Model	Pattern	Size	A	B	C
8C	Angle	1/2	2 ²⁷ / ₃₂ (72)	1 ¹ / ₄ (32)	—
8C	Angle	3/4	3 ¹ / ₈ (79)	1 ¹ / ₂ (38)	—
8C	Straightaway	3/4	3 ⁵ / ₃₂ (80)	1 ¹ / ₈ (29)	1 ⁵ / ₈ (41)

Ordering Information

NPT Model Number	BSPT Model Number	Size in.	NPT Part Number	BSPT Part Number	Differential Pressure Rating psi (bar)	Weight lbs. (kg)
8C-A-2-125 Angle	8C-A-2J-125 Angle 1/2"	1/2	402002	402008	125 (8.6)	1.5 (.7)
8C-A-3-125 Angle	8C-A-3J-125 Angle 3/4"	3/4	402003	402009	125 (8.6)	1.5 (.7)
8C-S-3-125 Straightaway		3/4	402004		125 (8.6)	1.5 (.6)

Gross Ratings

Series	Differential Across Trap psi (bar)											
	1/4 (.017)	1/2 (.034)	1 (.069)	1 1/2 (.10)	2 (.14)	5 (.35)	10 (.7)	15 (1.0)	25 (1.7)	50 (3.5)	100 (6.9)	125 (8.6)
8C	Capacity lbs./hr (kg/hr)											
	110 (50)	150 (68)	210 (95)	255 (116)	300 (136)	480 (218)	760 (345)	950 (431)	1350 (612)	2100 (953)	3500 (1590)	4200 (1905)

Series 8C capacities are based on 30° F (17°C) subcooling. Cold capacity is approximately 2 times capacity shown.

Thermostatic Steam Traps (continued)

Series 9C Balanced Pressure



The Series 9C are for institutional and commercial heating system applications or others that require high capacity operation.

- Subcooling for extremely efficient system operation and elimination of flash steam losses on low pressure systems.
- Sizes available:
 - 1" NPT Angle
- Replaceable Dura-Stat® module
- 3-Year Warranty
- Meets Mil specification A-A-60001 Type V, Style A, Class 1 - 4
- Stainless steel components
- Resistant to moderate water hammer and chemical attack
- Maximum operating pressure 125 psig (8.6 bar)



**Model 9C Angle
1" NPT**

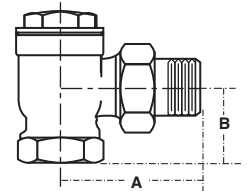

Dimensions, in. (mm)

Model	Pattern	Size	A	B
9C	Angle	1	3 ⁷ / ₃₂ (82)	1 ³ / ₄ (45)

Ordering Information

NPT Model Number	Size in.	NPT Part Number	Differential Pressure Rating psi (bar)	Weight lbs. (kg)
9C-A-4-125 Angle	1	402005	125 (8.6)	2.3 (1)

Gross Ratings

Series	Differential Across Trap psi (bar)											
	¼ (.017)	½ (.034)	1 (.069)	1½ (.10)	2 (.14)	5 (.35)	10 (.7)	15 (1.0)	25 (1.7)	50 (3.5)	100 (6.9)	125 (8.6)
9C	Capacity lbs./hr (kg/hr)											
	110 (50)	150 (68)	210 (95)	255 (116)	300 (136)	480 (218)	760 (345)	950 (431)	1350 (612)	2100 (953)	3500 (1590)	4200 (1905)

Thermostatic Steam Traps (continued)

Competitive brand changeover to Hoffman Specialty Model 17C

Manufacturer	Model Number	Dimensions in. (mm)		Hoffman Specialty Bear Trap Part Number
		A	B	
Barnes & Jones	122A	3 (76)	1¼ (32)	401536
Dunham Bush /Mepco	1E-AP	3⅛ (79)	1⅛ (29)	401536
Erwell	R30	3¼ (83)	1½ (38)	401536
Illinois	1G, 1GS 1MG	2⅞ (73)	1⅛ (29)	401542
Spirax Sarco	TS-25	2 ¹³ / ₁₆ (71)	1 ³ / ₁₆ (30)	401542
Sterling	7-50	3¼ (83)	1¼ (32)	401536
Trane	B1	3¼ (83)	1 ¹ / ₁₆ (27)	401536
Warren Webster	502, 702	2¾ (70)	1⅛ (29)	401542
Hoffman Specialty	17C w/std. nipple	3¼ (83)	1¼ (32)	401536
Hoffman Specialty	17C w/short nipple	2 ²⁷ / ₃₂ (72)	1¼ (32)	401542

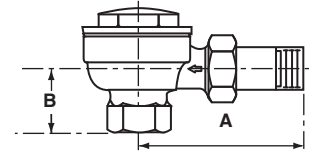

Dura-stat® Replacement Modules

For Barnes & Jones, Dunham-Bush, Illinois, Spirax-Sarco, and Hoffman Specialty Thermostatic Steam Traps.
The all Stainless Steel Dura-stat® Replacement Module should be used to upgrade thermostatic steam traps. The Dura-stat is durable and water hammer resistant.

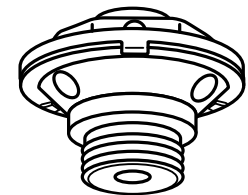

Selection

Trap Manufacturer	NPT Size in.	Model Number	 Dura-stat® Part Number:
Hoffman Specialty	½	17C	600084
Spirax-Sarco	½	TB-25, TH-25, TS-25, H	600056
Barnes & Jones	½	122	600053
Dunham-Bush/Mepco	½	1C, 1E	600052
Illinois	½	1G	600056
Warren Webster	½	02H, 502	600250

Inverted Bucket Steam Traps

Series B BEAR TRAP®

The Series B inverted bucket traps are designed for a wide range of industrial applications including steam mains, laundry and dry cleaning plants, food processing and those that require a lift in the discharge lines.

Series B0 Inverted Bucket Traps

The Series B0 Inverted Bucket Traps are designed for a wide range of industrial applications including unit heaters, laundry and process equipment and steam line drip traps.

These cast iron inverted bucket traps operate efficiently for long periods of time to add solid energy savings by lowering replacement and labor costs. They are fully repairable for even bigger maintenance savings.

Typical Applications:

- Drip traps in steam lines
- Tracer lines
- Process equipment
- Steam cookers
- Steam kettles
- Steam heated vats
- Pressing machinery
- Unit heaters
- Commercial dishwashing

Features:

- Available in sizes 1/2" and 3/4" NPT
- Pressure ratings 20, 80, 125 and 150 psig (1.4, 5.5, 8.6, and 10.3 bar)
- Removable covers for easy in-line service
- Stainless steel internal components
- Resistant to moderate water hammer
- Optional built-in strainer to reduce the number of piping connections
- Maximum capacities to 690 lbs/hr (313 kg/hr)
- Maximum temperature 406°F (208°C)
- Maximum allowable pressure (vessel design) 250 psig (17.3 bar)
- Maximum operating pressure 150 psig (10.3 bar)



Materials of Construction	
Part	Specifications
Body and cover	Cast Iron
Valve Pin and Seat	Stainless Steel (Hardened)
Bucket	Stainless Steel
Lever Assembly	Stainless Steel
Strainer	Stainless Steel
Cover Gasket	Non-asbestos fiber
Cover Bolts	Grade 8

Dimensions in. (mm)

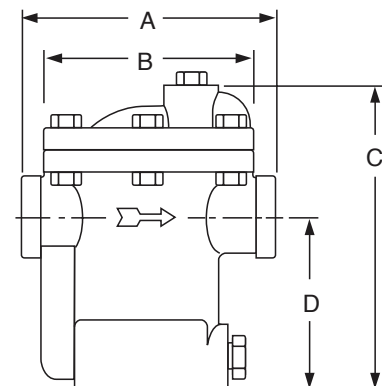

NPT Size	A	B (Dia.)	C	D
1/2 & 3/4	5 ¹ / ₁₆ (129)	3 ³ / ₄ (95)	6 ³ / ₁₆ (157)	3 ¹ / ₂ (89)

Capacities (Gross Ratings)

Series	Orifice Size in. (mm)	Seat Pressure psi (bar)	Differential Pressure psig (bar)													
			1/2 (.035)	1 (0.07)	5 (0.35)	10 (0.69)	15 (1.03)	20 (1.38)	30 (2.1)	40 (2.8)	50 (3.5)	60 (4.2)	80 (5.5)	100 (6.9)	125 (8.6)	150 (10.3)
			Capacities lbs./hr (kg/hr)													
B0	3/16 (4.7)	20 (1.4)	200 (91)	270 (122)	450 (204)	560 (254)	640 (290)	690 (313)								
	1/8 (3.2)	80 (5.5)	80 (36)	110 (50)	200 (91)	300 (136)	360 (163)	420 (190)	500 (227)	540 (245)	580 (263)	620 (281)	690 (313)			
	7/64 (2.8)	125 (8.6)		55 (25)	90 (41)	145 (66)	195 (88)	260 (118)	345 (156)	400 (181)	442 (200)	485 (220)	565 (256)	640 (290)	680 (308)	
	3/32 (2.4)	150 (10.3)			70 (32)	110 (50)	150 (68)	200 (91)	270 (122)	310 (141)	345 (156)	380 (172)	440 (200)	480 (218)	540 (245)	570 (259)

Ordering Information (Specify the part number on your order)

Model (A) units are basic.

Model (S) units have built-in strainer.

NPT Model Number	BSPT Model Number	Size in.	NPT Part Number	BSPT Part Number	Seat Differential Pressure Rating psi (bar)	Body Design Pressure psi (bar)	Weight lbs. (kg)
B0020A-2	B0020A-2J	1/2	404180	404131	20 (1.4)	250 (17.3)	7 (3)
B0020S-2	B0020S-2J	1/2	404184	404135	20 (1.4)	250 (17.3)	8 (3)
B0080A-2	B0080A-2J	1/2	404181	404132	80 (5.5)	250 (17.3)	9 (3)
B0080S-2	B0080S-2J	1/2	404185	404136	80 (5.5)	250 (17.3)	10 (3)
B0125A-2	B0125A-2J	1/2	404182	404133	125 (8.6)	250 (17.3)	11 (3)
B0125S-2	B0125S-2J	1/2	404186	404137	125 (8.6)	250 (17.3)	12 (3)
B0150A-2	B0150A-2J	1/2	404183	404134	150 (10.3)	250 (17.3)	13 (3)
B0150S-2	B0150S-2J	1/2	404187	404138	150 (10.3)	250 (17.3)	14 (3)
B0020A-3	B0020A-3J	3/4	404188	404139	20 (1.4)	250 (17.3)	15 (3)
B0020S-3	B0020S-3J	3/4	404192	404143	20 (1.4)	250 (17.3)	16 (3)
B0080A-3	B0080A-3J	3/4	404189	404140	80 (5.5)	250 (17.3)	17 (3)
B0080S-3	B0080S-3J	3/4	404193	404144	80 (5.5)	250 (17.3)	18 (3)
B0125A-3	B0125A-3J	3/4	404190	404141	125 (8.6)	250 (17.3)	19 (3)
B0125S-3	B0125S-3J	3/4	404194	404145	125 (8.6)	250 (17.3)	20 (3)
B0150A-3	B0150A-3J	3/4	404191	404142	150 (10.3)	250 (17.3)	21 (3)
B0150S-3	B0150S-3J	3/4	404195	404146	150 (10.3)	250 (17.3)	22 (3)

Inverted Bucket Steam Traps

Series B

The Series B inverted bucket traps are designed for a wide range of industrial applications including steam mains, laundry and dry cleaning plants, food processing and those that require a lift in the discharge lines.

Series B

Series B1

- Available in sizes 1/2" and 3/4" NPT and BSPT
- Meets Mil specification WW-T-696-E Type I, Style B, Class 1-7
- Removable covers for easy in-line service
- Erosion resistant covers
- Stainless steel internal components
- Resistant to moderate water hammer
- Optional built-in thermic vent for faster heating
- Optional built-in strainer to reduce the number of piping connections
- Maximum capacities to 1700 lbs/hr. (771 kg/hr.)
- Maximum temperature 406°F (208°C)
- Maximum operating pressure 250 psig (17.3 bar)



Series B1

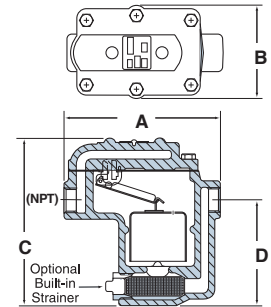

Series B2

- 3/4" NPT and BSPT
- Meets Mil specification WW-T-696-E Type I, Style B, Class 1-7
- Removable covers for easy in-line service
- Erosion resistant covers
- Stainless steel internal components
- Resistant to moderate water hammer
- Optional built-in thermic vent for faster heating
- Optional built-in strainer to reduce the number of piping connections
- Maximum capacities to 2620 lbs./hr (1188 kg/hr.)
- Maximum temperature 406°F (208°C)
- Maximum operating pressure 250 psig (17.3 bar)



Series B2

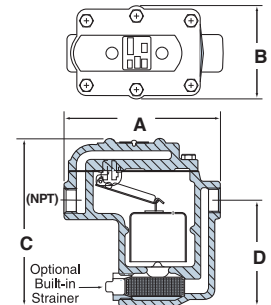

Materials of Construction	
Part	Specifications
Body and cover	Cast Iron 30,000 psi tensile
Valve Pin and Seat	Stainless Steel (Hardened)
Bucket	Stainless Steel
Lever Assembly	Stainless Steel
Cover Bolts	Grade 5 Steel

Dimensions in. (mm)

Series	Size	A	B	C	D
B1	1/2, 3/4	6 ¹⁵ / ₁₆ (177)	3 ¹³ / ₁₆ (97)	7 ¹ / ₄ (184)	4 ³ / ₈ (111)
B2	3/4	6 ¹⁵ / ₁₆ (177)	3 ¹³ / ₁₆ (97)	9 ¹ / ₁₆ (230)	6 ⁷ / ₈ (158)

Series B BEARTRAP®

How to Select

The trap capacity should be selected based on the minimum differential pressure between the inlet pressure and outlet pressure. The trap seat must be capable of opening against the maximum inlet steam pressure. When the traps are used on applications where the steam is controlled by a modulating temperature regulator, the trap is normally selected to handle the full condensate load including safety factor at 1/2 psi (.034 bar) differential pressure.

Capacities (Gross Ratings)

Series	Orifice Size in. (mm)	Seat Pressure psi (bar)	Differential Pressure psig (bar)																
			1/2 (.035)	1 (0.07)	2 (0.14)	5 (0.35)	10 (0.69)	15 (1.0)	20 (1.4)	30 (2.1)	40 (2.8)	50 (3.5)	60 (4.2)	75 (5.2)	100 (6.9)	125 (8.6)	180 (12.4)	200 (13.8)	250 (17.3)
B1	Capacities lbs./hr (kg/hr)																		
	.250	15	500	650	835	1145	1490	1700											
	(6.4)	(1.0)	(227)	(295)	(379)	(519)	(676)	(771)											
	.187	30	260	345	460	680	905	1060	1200	1440									
	(4.7)	(2.1)	(118)	(156)	(209)	(308)	(411)	(481)	(544)	(653)									
	.156	75	200	255	335	480	605	695	775	900	980	1070	1130	1200					
	(4.0)	(5.2)	(91)	(116)	(152)	(218)	(274)	(315)	(352)	(408)	(445)	(485)	(513)	(544)					
	.125	125	115	150	195	275	355	410	460	530	595	640	690	745	830	920			
	(3.2)	(8.6)	(52)	(68)	(88)	(125)	(161)	(186)	(209)	(240)	(270)	(290)	(313)	(338)	(376)	(417)			
	.094	180	80	105	140	205	275	320	360	425	480	520	560	620	705	780	930		
(2.4)	(10.4)	(36)	(48)	(64)	(93)	(125)	(145)	(163)	(193)	(218)	(236)	(254)	(281)	(320)	(354)	(422)			
.070	250	28	40	55	90	125	150	175	215	250	275	305	340	400	450	570	600	700	
(1.8)	(17)	(13)	(18)	(25)	(41)	(57)	(68)	(79)	(98)	(113)	(125)	(138)	(154)	(181)	(204)	(259)	(272)	(318)	
B2	.360	15	750	975	1255	1755	2280	2620											
	(9.1)	(1.0)	(340)	(447)	(569)	(796)	(1034)	(1188)											
	.282	30	650	810	1005	1350	1700	1950	2130	2400									
	(7.1)	(2.1)	(295)	(367)	(456)	(612)	(771)	(885)	(966)	(1089)									
	.250	75	490	600	740	980	1220	1340	1440	1600	1760	1910	2030	2170					
	(6.4)	(5.2)	(222)	(272)	(336)	(445)	(553)	(608)	(653)	(726)	(798)	(866)	(921)	(984)					
	.203	125	350	450	580	830	905	920	1020	1180	1310	1430	1540	1680	1920	2100			
	(5.2)	(8.6)	(159)	(204)	(263)	(376)	(411)	(417)	(463)	(535)	(594)	(649)	(699)	(762)	(871)	(953)			
	.156	180	200	255	330	460	580	675	740	840	930	1020	1090	1190	1350	1480	1725		
	(4.0)	(10.4)	(91)	(116)	(150)	(209)	(263)	(306)	(336)	(381)	(422)	(463)	(494)	(540)	(612)	(671)	(782)		
.141	250	180	235	305	430	540	620	680	780	870	940	1000	1100	1270	1415	1650	1740	1890	
(3.6)	(17)	(82)	(107)	(138)	(195)	(245)	(281)	(308)	(354)	(395)	(426)	(453)	(499)	(576)	(642)	(748)	(789)	(857)	

Inverted Bucket Steam Traps (continued)

Ordering Information (Specify the part number on your order)

Model (A) units are basic.

Model (B) units have a built-in strainer and thermic vent for fast venting.

Model (S) units have a built-in strainer.

Model (T) units have an optional thermic vent built-in for faster venting.

Example: Model Number B1030A-2

B1 (Unit size selected from capacity table)

030 (Differential seat pressure rating)

A (Basic Unit)

2 (Connection Size - 1/4 of an inch)

Series B1 Ordering Information

NPT Model Number	BSPT Model Number	Size in.	NPT Part Number	BSPT Part Number	Seat Differential Pressure Rating psi (bar)	Body Design Pressure psi (bar)	Weight lbs. (kg)
B1015A-2	B1015A-2J	1/2	404300	404600	15 (1.0)	250 (17.3)	11 (5)
B1015S-2	B1015S-2J	1/2	404301	404601	15 (1.0)	250 (17.3)	11 (5)
B1015T-2	B1015T-2J	1/2	404302	404602	15 (1.0)	250 (17.3)	11 (5)
B1015B-2	B1015B-2J	1/2	404303	404603	15 (1.0)	250 (17.3)	11 (5)
B1015A-3	B1015A-3J	3/4	404324	404624	15 (1.0)	250 (17.3)	11 (5)
B1015S-3	B1015S-3J	3/4	404325	404625	15 (1.0)	250 (17.3)	11 (5)
B1015T-3	B1015T-3J	3/4	404326	404626	15 (1.0)	250 (17.3)	11 (5)
B1015B-3	B1015B-3J	3/4	404327	404627	15 (1.0)	250 (17.3)	11 (5)
B1030A-2	B1030A-2J	1/2	404304	404604	30 (2.1)	250 (17.3)	11 (5)
B1030S-2	B1030S-2J	1/2	404305	404605	30 (2.1)	250 (17.3)	11 (5)
B1030T-2	B1030T-2J	1/2	404306	404606	30 (2.1)	250 (17.3)	11 (5)
B1030B-2	B1030B-2J	1/2	404307	404607	30 (2.1)	250 (17.3)	11 (5)
B1030A-3	B1030A-3J	3/4	404328	404628	30 (2.1)	250 (17.3)	11 (5)
B1030S-3	B1030S-3J	3/4	404329	404629	30 (2.1)	250 (17.3)	11 (5)
B1030T-3	B1030T-3J	3/4	404330	404630	30 (2.1)	250 (17.3)	11 (5)
B1030B-3	B1030B-3J	3/4	404331	404631	30 (2.1)	250 (17.3)	11 (5)
B1075A-2	B1075A-2J	1/2	404308	404608	75 (5.2)	250 (17.3)	11 (5)
B1075S-2	B1075S-2J	1/2	404309	404609	75 (5.2)	250 (17.3)	11 (5)
B1075T-2	B1075T-2J	1/2	404310	404610	75 (5.2)	250 (17.3)	11 (5)
B1075B-2	B1075B-2J	1/2	404311	404611	75 (5.2)	250 (17.3)	11 (5)
B1075A-3	B1075A-3J	3/4	404332	404632	75 (5.2)	250 (17.3)	11 (5)
B1075S-3	B1075S-3J	3/4	404333	404633	75 (5.2)	250 (17.3)	11 (5)
B1075T-3	B1075T-3J	3/4	404334	404634	75 (5.2)	250 (17.3)	11 (5)
B1075B-3	B1075B-3J	3/4	404335	404635	75 (5.2)	250 (17.3)	11 (5)
B1125A-2	B1125A-2J	1/2	404312	404612	125 (8.6)	250 (17.3)	11 (5)
B1125S-2	B1125S-2J	1/2	404313	404613	125 (8.6)	250 (17.3)	11 (5)
B1125T-2	B1125T-2J	1/2	404314	404614	125 (8.6)	250 (17.3)	11 (5)
B1125B-2	B1125B-2J	1/2	404315	404615	125 (8.6)	250 (17.3)	11 (5)
B1125A-3	B1125A-3J	3/4	404336	404636	125 (8.6)	250 (17.3)	11 (5)
B1125S-3	B1125S-3J	3/4	404337	404637	125 (8.6)	250 (17.3)	11 (5)
B1125T-3	B1125T-3J	3/4	404338	404638	125 (8.6)	250 (17.3)	11 (5)
B1125B-3	B1125B-3J	3/4	404339	404639	125 (8.6)	250 (17.3)	11 (5)

Series B BEARTRAP®
Series B1 Ordering Information - continued

NPT Model Number	BSPT Model Number	Size in.	NPT Part Number	BSPT Part Number	Seat Differential Pressure Rating psi (bar)	Body Design Pressure psi (bar)	Weight lbs. (kg)
B1180A-2	B1180A-2J	1/2	404316	404616	180 (12.4)	250 (17.3)	11 (5)
B1180S-2	B1180S-2J	1/2	404317	404617	180 (12.4)	250 (17.3)	11 (5)
B1180T-2	B1180T-2J	1/2	404318	404618	180 (12.4)	250 (17.3)	11 (5)
B1180B-2	B1180B-2J	1/2	404319	404619	180 (12.4)	250 (17.3)	11 (5)
B1180A-3	B1180A-3J	3/4	404340	404640	180 (12.4)	250 (17.3)	11 (5)
B1180S-3	B1180S-3J	3/4	404341	404641	180 (12.4)	250 (17.3)	11 (5)
B1180T-3	B1180T-3J	3/4	404342	404642	180 (12.4)	250 (17.3)	11 (5)
B1180B-3	B1180B-3J	3/4	404343	404643	180 (12.4)	250 (17.3)	11 (5)
B1250A-2	B1250A-2J	1/2	404320	404620	250 (17.3)	250 (17.3)	11 (5)
B1250S-2	B1250S-2J	1/2	404321	404621	250 (17.3)	250 (17.3)	11 (5)
B1250T-2	B1250T-2J	1/2	404322	404622	250 (17.3)	250 (17.3)	11 (5)
B1250B-2	B1250B-2J	1/2	404323	404623	250 (17.3)	250 (17.3)	11 (5)
B1250A-3	B1250A-3J	3/4	404344	404644	250 (17.3)	250 (17.3)	11 (5)
B1250S-3	B1250S-3J	3/4	404345	404645	250 (17.3)	250 (17.3)	11 (5)
B1250T-3	B1250T-3J	3/4	404346	404646	250 (17.3)	250 (17.3)	11 (5)
B1250B-3	B1250B-3J	3/4	404347	404647	250 (17.3)	250 (17.3)	11 (5)

Series B2 Ordering Information

NPT Model Number	BSPT Model Number	Size in.	NPT Part Number	BSPT Part Number	Seat Differential Pressure Rating psi (bar)	Body Design Pressure psi (bar)	Weight lbs. (kg)
B2015A-3	B2015A-3J	3/4	404348	404648	15 (1.0)	250 (17.3)	12.5 (5.7)
B2015S-3	B2015S-3J	3/4	404349	404649	15 (1.0)	250 (17.3)	12.5 (5.7)
B2015T-3	B2015T-3J	3/4	404350	404650	15 (1.0)	250 (17.3)	12.5 (5.7)
B2015B-3	B2015B-3J	3/4	404351	404651	15 (1.0)	250 (17.3)	12.5 (5.7)
B2030A-3	B2030A-3J	3/4	404352	404652	30 (2.1)	250 (17.3)	12.5 (5.7)
B2030S-3	B2030S-3J	3/4	404353	404653	30 (2.1)	250 (17.3)	12.5 (5.7)
B2030T-3	B2030T-3J	3/4	404354	404654	30 (2.1)	250 (17.3)	12.5 (5.7)
B2030B-3	B2030B-3J	3/4	404355	404655	30 (2.1)	250 (17.3)	12.5 (5.7)
B2075A-3	B2075A-3J	3/4	404356	404656	75 (5.2)	250 (17.3)	12.5 (5.7)
B2075S-3	B2075S-3J	3/4	404357	404657	75 (5.2)	250 (17.3)	12.5 (5.7)
B2075T-3	B2075T-3J	3/4	404358	404658	75 (5.2)	250 (17.3)	12.5 (5.7)
B2075B-3	B2075B-3J	3/4	404359	404659	75 (5.2)	250 (17.3)	12.5 (5.7)
B2125A-3	B2125A-3J	3/4	404360	404660	125 (8.6)	250 (17.3)	12.5 (5.7)
B2125S-3	B2125S-3J	3/4	404361	404661	125 (8.6)	250 (17.3)	12.5 (5.7)
B2125T-3	B2125T-3J	3/4	404362	404662	125 (8.6)	250 (17.3)	12.5 (5.7)
B2125B-3	B2125B-3J	3/4	404363	404663	125 (8.6)	250 (17.3)	12.5 (5.7)
B2180A-3	B2180A-3J	3/4	404364	404664	180 (12.4)	250 (17.3)	12.5 (5.7)
B2180S-3	B2180S-3J	3/4	404365	404665	180 (12.4)	250 (17.3)	12.5 (5.7)
B2180T-3	B2180T-3J	3/4	404366	404666	180 (12.4)	250 (17.3)	12.5 (5.7)
B2180B-3	B2180B-3J	1/2	404367	404667	250 (17.3)	250 (17.3)	12.5 (5.7)
B2250A-3	B2250A-3J	3/4	404368	404668	250 (17.3)	250 (17.3)	12.5 (5.7)
B2250S-3	B2250S-3J	3/4	404369	404669	250 (17.3)	250 (17.3)	12.5 (5.7)
B2250T-3	B2250T-3J	3/4	404370	404670	250 (17.3)	250 (17.3)	12.5 (5.7)
B2250B-3	B2250B-3J	3/4	404371	404671	250 (17.3)	250 (17.3)	12.5 (5.7)

Inverted Bucket Steam Traps (continued)

Series B

Series B3

- Available in sizes ¾" and 1" NPT and BSPT
- Meets Mil specification WW-T-696-E Type I, Style B, Class 1-7
- Removable covers for easy in-line service
- Stainless steel internal components
- Resistant to moderate water hammer
- Optional built-in thermic vent for faster heating
- Optional built-in strainer to reduce the number of piping connections
- Maximum capacities to 5000 lbs/hr (2268 kg/hr.)
- Maximum temperature 406°F (208°C)
- Maximum operating pressure 250 psig (17.3 bar)



Series B3

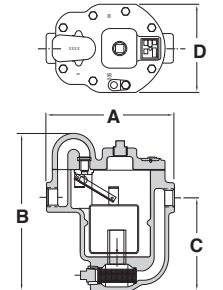

Series B4

- Available in sizes 1", 1¼", 1½" NPT and BSPT
- Meets Mil specification WW-T-696-E Type I, Style B, Class 1-7
- Removable covers for easy in-line service
- Stainless steel internal components
- Resistant to moderate water hammer
- Optional built-in thermic vent for faster heating
- Optional built-in strainer to reduce the number of piping connections
- Maximum capacities to 9424 lbs/hr (4275 kg/hr.)
- Maximum temperature 406°F (208°C)
- Maximum operating pressure 250 psig (17.3 bar)



Series B4

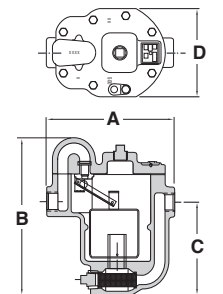

Materials of Construction	
Part	Specifications
Body and cover	Cast Iron 30,000 psi tensile
Valve Pin and Seat	Stainless Steel (Hardened)
Bucket	Stainless Steel
Lever Assembly	Stainless Steel
Cover Bolts	Grade 5 Steel

Dimensions in. (mm)

Series	Size	A	B	C	D
B3	¾, 1	9 ⁷ / ₁₆ (239)	11 ⁵ / ₈ (294)	6 ⁷ / ₈ (174)	6 ⁹ / ₁₆ (166)
B4	1, 1¼, 1½	11 ³ / ₈ (289)	14 ³ / ₁₆ (360)	8 ⁵ / ₁₆ (211)	8 ¹ / ₈ (206)

Series B BEAR TRAP®

Capacities (Gross Ratings)

Series	Orifice Size In (mm)	Seat Pressure psi (bar)	Differential Pressure psig (bar)																	
			1/2 (.035)	1 (0.07)	2 (0.14)	5 (0.35)	10 (0.69)	15 (1.0)	20 (1.4)	30 (2.1)	40 (2.8)	50 (3.5)	60 (4.2)	75 (5.2)	100 (6.9)	125 (8.6)	180 (12.4)	200 (13.8)	250 (17)	
			Capacity lbs./hr. (kg/hr.)																	
B3	.500	15	1450	1850	2300	3050	3700	4100	-	-	-	-	-	-	-	-	-	-	-	
	(12.7)	(1.0)	(658)	(839)	(1043)	(1383)	(1678)	(1860)	-	-	-	-	-	-	-	-	-	-	-	-
	.375	30	720	980	1340	2020	2760	3300	3750	4470	-	-	-	-	-	-	-	-	-	-
	(9.53)	(2.1)	(327)	(435)	(608)	(916)	(1252)	(1497)	(1701)	(2028)	-	-	-	-	-	-	-	-	-	-
	.281	75	500	680	915	1370	1860	2200	2500	2980	3370	3720	4050	4460	-	-	-	-	-	-
	(7.14)	(5.2)	(227)	(308)	(415)	(621)	(762)	(998)	(1134)	(1352)	(1529)	(1687)	(1837)	(2023)	-	-	-	-	-	-
	.250	125	435	590	800	1200	1630	1950	2220	2665	3020	3325	3600	3970	4540	5000	-	-	-	-
	(6.35)	(8.6)	(197)	(268)	(363)	(544)	(739)	(885)	(1007)	(1209)	(1370)	(1508)	(1633)	(1801)	(2059)	(2268)	-	-	-	-
	.219	180	300	415	570	870	1190	1440	1640	1970	2250	2490	2690	2960	3400	3790	4440	-	-	-
	(5.56)	(10.4)	(136)	(188)	(259)	(395)	(540)	(653)	(744)	(894)	(1021)	(1129)	(1220)	(1343)	(1542)	(1719)	(2014)	-	-	-
.188	250	256	355	485	740	1010	1210	1390	1675	1900	2100	2285	2535	2890	3200	3780	3980	4340	-	
(4.78)	(17)	(116)	(161)	(220)	(336)	(458)	(549)	(631)	(760)	(862)	(953)	(1036)	(1150)	(1311)	(1452)	(1715)	(1805)	(1969)	-	
B4	.625	15	2382	2991	3755	5071	6366	7272	-	-	-	-	-	-	-	-	-	-	-	
	(16)	(1.0)	(1080)	(1357)	(1703)	(2300)	(2888)	(3300)	-	-	-	-	-	-	-	-	-	-	-	
	.5	30	1565	2053	2693	3855	5056	5926	6633	7774	-	-	-	-	-	-	-	-	-	
	(12.7)	(2.1)	(710)	(931)	(1222)	(1749)	(2293)	(2688)	(3009)	(3526)	-	-	-	-	-	-	-	-	-	
	.375	75	825	1137	1568	2396	3302	3983	4550	5489	6271	6953	7566	8389	-	-	-	-	-	
	(9.53)	(5.2)	(374)	(516)	(711)	(1087)	(1498)	(1798)	(2064)	(2490)	(2845)	(3154)	(3432)	(3805)	-	-	-	-	-	
	.344	125	780	1067	1459	2205	3015	3621	4122	4950	5636	6233	6767	7484	8522	9424	-	-	-	
	(7.7)	(8.6)	(354)	(484)	(662)	(1000)	(1377)	(1642)	(1870)	(2245)	(2556)	(2827)	(3069)	(3395)	(3866)	(4275)	-	-	-	
	.281	180	522	719	991	1516	2089	2521	2881	3476	3971	4403	4791	5313	6070	6732	7970	-	-	
	(7.14)	(10.4)	(237)	(326)	(450)	(688)	(948)	(1144)	(1307)	(1577)	(1801)	(1997)	(2173)	(2410)	(2753)	(3054)	(3615)	-	-	
.25	250	389	543	759	1180	1649	2005	2303	2801	3218	3583	3913	4357	5006	5574	6646	6993	7787		
(6.35)	(17)	(176)	(246)	(344)	(535)	(748)	(909)	(1045)	(1271)	(1460)	(1625)	(1775)	(1976)	(2270)	(2528)	(3015)	(3172)	(3532)		

Steam Traps

Ordering Information (Specify the part number on your order)

Model (A) units are basic.
Model (B) units have a built-in strainer and thermic vent for fast venting.
Model (S) units have a built-in strainer.
Model (T) units have an optional thermic vent built-in for faster venting.

Example:
Model Number B3030A-3J
B3 (Unit size selected from capacity table)
030 (Differential seat pressure rating)
A (Basic Unit)
3 (Connection Size - 1/4 of an inch)
J (BSPT Thread Option)

Series B3 Ordering Information

NPT Model Number	BSPT Model Number	NPT Size in.	NPT Part Number	BSPT Part Number	Seat Differential Pressure Rating psi (bar)	Body Design Pressure psi (bar)	Weight lbs. (kg)
B3015A-3	B3015A-3J	3/4	404400	404752	15 (1.0)	250 (17.3)	35 (16)
B3015S-3	B3015S-3J	3/4	404406	404758	15 (1.0)	250 (17.3)	35 (16)
B3015T-3	B3015T-3J	3/4	404412	404763	15 (1.0)	250 (17.3)	35 (16)
B3015B-3	B3015B-3J	3/4	404418	404769	15 (1.0)	250 (17.3)	35 (16)
B3015A-4	B3015A-4J	1	404424	404775	15 (1.0)	250 (17.3)	35 (16)
B3015S-4	B3015S-4J	1	404430	404781	15 (1.0)	250 (17.3)	35 (16)
B3015T-4	B3015T-4J	1	404436	404787	15 (1.0)	250 (17.3)	35 (16)
B3015B-4	B3015B-4J	1	404442	404793	15 (1.0)	250 (17.3)	35 (16)
B3030A-3	B3030A-3J	3/4	404401	404753	30 (2.1)	250 (17.3)	35 (16)
B3030S-3	B3030S-3J	3/4	404407	404759	30 (2.1)	250 (17.3)	35 (16)
B3030T-3	B3030T-3J	3/4	404413	404764	30 (2.1)	250 (17.3)	35 (16)
B3030B-3	B3030B-3J	3/4	404419	404770	30 (2.1)	250 (17.3)	35 (16)
B3030A-4	B3030A-4J	1	404425	404776	30 (2.1)	250 (17.3)	35 (16)
B3030S-4	B3030S-4J	1	404431	404782	30 (2.1)	250 (17.3)	35 (16)
B3030T-4	B3030T-4J	1	404437	404788	30 (2.1)	250 (17.3)	35 (16)
B3030B-4	B3030B-4J	1	404443	404794	30 (2.1)	250 (17.3)	35 (16)

Inverted Bucket Steam Traps (continued)

Series B BEAR TRAP®

Ordering Information (Specify the part number on your order)

Model (A) units are basic.

Model (B) units have a built-in strainer and thermic vent for fast venting.

Model (S) units have a built-in strainer.

Model (T) units have an optional thermic vent built-in for faster venting.

Example: Model Number B3030A-3J

B3 (Unit size selected from capacity table)

030 (Differential seat pressure rating)

A (Basic Unit)

3 (Connection Size - 1/4 of an inch)

J (BSPT Thread Option)

Series B3 Ordering Information - continued

NPT Model Number	BSPT Model Number	Size in.	NPT Part Number	BSPT Part Number	Seat Differential Pressure Rating psi (bar)	Body Design Pressure psi (bar)	Weight lbs. (kg)
B3075A-3	B3075A-3J	3/4	404402	404754	75 (5.2)	250 (17.3)	35 (16)
B3075S-3	B3075S-3J	3/4	404408	404760	75 (5.2)	250 (17.3)	35 (16)
B3075T-3	B3075T-3J	3/4	404414	404765	75 (5.2)	250 (17.3)	35 (16)
B3075B-3	B3075B-3J	3/4	404420	404771	75 (5.2)	250 (17.3)	35 (16)
B3075A-4	B3075A-4J	1	404426	404777	75 (5.2)	250 (17.3)	35 (16)
B3075S-4	B3075S-4J	1	404432	404783	75 (5.2)	250 (17.3)	35 (16)
B3075T-4	B3075T-4J	1	404438	404789	75 (5.2)	250 (17.3)	35 (16)
B3075B-4	B3075B-4J	1	404444	404478	75 (5.2)	250 (17.3)	35 (16)
B3125A-3	B3125A-3J	3/4	404403	404755	125 (8.6)	250 (17.3)	35 (16)
B3125S-3	B3125S-3J	3/4	404409	404479	125 (8.6)	250 (17.3)	35 (16)
B3125T-3	B3125T-3J	3/4	404415	404766	125 (8.6)	250 (17.3)	35 (16)
B3125B-3	B3125B-3J	3/4	404421	404772	125 (8.6)	250 (17.3)	35 (16)
B3125A-4	B3125A-4J	1	404427	404778	125 (8.6)	250 (17.3)	35 (16)
B3125S-4	B3125S-4J	1	404433	404784	125 (8.6)	250 (17.3)	35 (16)
B3125T-4	B3125T-4J	1	404439	404790	125 (8.6)	250 (17.3)	35 (16)
B3125B-4	B3125B-4J	1	404445	404795	125 (8.6)	250 (17.3)	35 (16)
B3180A-3	B3180A-3J	3/4	404404	404756	180 (12.4)	250 (17.3)	35 (16)
B3180S-3	B3180S-3J	3/4	404410	404761	180 (12.4)	250 (17.3)	35 (16)
B3180T-3	B3180T-3J	3/4	404416	404767	180 (12.4)	250 (17.3)	35 (16)
B3180B-3	B3180B-3J	3/4	404422	404773	180 (12.4)	250 (17.3)	35 (16)
B3180A-4	B3180A-4J	1	404428	404779	180 (12.4)	250 (17.3)	35 (16)
B3180S-4	B3180S-4J	1	404434	404785	180 (12.4)	250 (17.3)	35 (16)
B3180T-4	B3180T-4J	1	404440	404791	180 (12.4)	250 (17.3)	35 (16)
B3180B-4	B3180B-4J	1	404446	404796	180 (12.4)	250 (17.3)	35 (16)
B3250A-3	B3250A-3J	3/4	404405	404757	250 (17.3)	250 (17.3)	35 (16)
B3250S-3	B3250S-3J	3/4	404411	404762	250 (17.3)	250 (17.3)	35 (16)
B3250T-3	B3250T-3J	3/4	404417	404768	250 (17.3)	250 (17.3)	35 (16)
B3250B-3	B3250B-3J	3/4	404423	404774	250 (17.3)	250 (17.3)	35 (16)
B3250A-4	B3250A-4J	1	404429	404780	250 (17.3)	250 (17.3)	35 (16)
B3250S-4	B3250S-4J	1	404435	404786	250 (17.3)	250 (17.3)	35 (16)
B3250T-4	B3250T-4J	1	404441	404792	250 (17.3)	250 (17.3)	35 (16)
B3250B-4	B3250B-4J	1	404447	404797	250 (17.3)	250 (17.3)	35 (16)

Series B 
Series B4 Ordering Information

NPT Model Number	BSPT Model Number	Size in.	NPT Part Number	BSPT Part Number	Seat Differential Pressure Rating		Body Design Pressure		Weight	
					psi	(bar)	psi	(bar)	lbs.	(kg)
B4015A-4	B4015A-4J	1	404500	404798	15	(1.0)	250	(17.3)	61	(28)
B4015S-4	B4015S-4J	1	404506	404804	15	(1.0)	250	(17.3)	61	(28)
B4015T-4	B4015T-4J	1	404512	404810	15	(1.0)	250	(17.3)	61	(28)
B4015B-4	B4015B-4J	1	404518	404816	15	(1.0)	250	(17.3)	61	(28)
B4015A-5	B4015A-5J	1¼	404524	404822	15	(1.0)	250	(17.3)	61	(28)
B4015S-5	B4015S-5J	1¼	404530	404828	15	(1.0)	250	(17.3)	61	(28)
B4015T-5	B4015T-5J	1¼	404536	404833	15	(1.0)	250	(17.3)	61	(28)
B4015B-5	B4015B-5J	1¼	404542	404839	15	(1.0)	250	(17.3)	61	(28)
B4015A-6	B4015A-6J	1½	404548	404845	15	(1.0)	250	(17.3)	61	(28)
B4015S-6	B4015S-6J	1½	404554	404851	15	(1.0)	250	(17.3)	61	(28)
B4015T-6	B4015T-6J	1½	404560	404856	15	(1.0)	250	(17.3)	61	(28)
B4015B-6	B4015B-6J	1½	404566	404862	15	(1.0)	250	(17.3)	61	(28)
B4030A-4	B4030A-4J	1	404501	404799	30	(2.1)	250	(17.3)	61	(28)
B4030S-4	B4030S-4J	1	404507	404805	30	(2.1)	250	(17.3)	61	(28)
B4030T-4	B4030T-4J	1	404513	404811	30	(2.1)	250	(17.3)	61	(28)
B4030B-4	B4030B-4J	1	404519	404817	30	(2.1)	250	(17.3)	61	(28)
B4030A-5	B4030A-5J	1¼	404525	404823	30	(2.1)	250	(17.3)	61	(28)
B4030S-5	B4030S-5J	1¼	404531	404829	30	(2.1)	250	(17.3)	61	(28)
B4030T-5	B4030T-5J	1¼	404537	404934	30	(2.1)	250	(17.3)	61	(28)
B4030B-5	B4030B-5J	1¼	404543	404840	30	(2.1)	250	(17.3)	61	(28)
B4030A-6	B4030A-6J	1½	404549	404846	30	(2.1)	250	(17.3)	61	(28)
B4030S-6	B4030S-6J	1½	404555	404852	30	(2.1)	250	(17.3)	61	(28)
B4030T-6	B4030T-6J	1½	404561	404857	30	(2.1)	250	(17.3)	61	(28)
B4030B-6	B4030B-6J	1½	404567	404863	30	(2.1)	250	(17.3)	61	(28)
B4075A-4	B4075A-4J	1	404502	404800	75	(5.2)	250	(17.3)	61	(28)
B4075S-4	B4075S-4J	1	404508	404806	75	(5.2)	250	(17.3)	61	(28)
B4075T-4	B4075T-4J	1	404514	404812	75	(5.2)	250	(17.3)	61	(28)
B4075B-4	B4075B-4J	1	404520	404818	75	(5.2)	250	(17.3)	61	(28)
B4075A-5	B4075A-5J	1¼	404526	404824	75	(5.2)	250	(17.3)	61	(28)
B4075S-5	B4075S-5J	1¼	404532	404830	75	(5.2)	250	(17.3)	61	(28)
B4075T-5	B4075T-5J	1¼	404538	404835	75	(5.2)	250	(17.3)	61	(28)
B4075B-5	B4075B-5J	1¼	404544	404841	75	(5.2)	250	(17.3)	61	(28)
B4075A-6	B4075A-6J	1½	404550	404847	75	(5.2)	250	(17.3)	61	(28)
B4075S-6	B4075S-6J	1½	404556	404853	75	(5.2)	250	(17.3)	61	(28)
B4075T-6	B4075T-6J	1½	404562	404858	75	(5.2)	250	(17.3)	61	(28)
B4075B-6	B4075B-6J	1½	404568	404864	75	(5.2)	250	(17.3)	61	(28)
B4125A-4	B4125A-4J	1	404503	404801	125	(8.6)	250	(17.3)	61	(28)
B4125S-4	B4125S-4J	1	404509	404807	125	(8.6)	250	(17.3)	61	(28)
B4125T-4	B4125T-4J	1	404515	404813	125	(8.6)	250	(17.3)	61	(28)
B4125B-4	B4125B-4J	1	404521	404819	125	(8.6)	250	(17.3)	61	(28)
B4125A-5	B4125A-5J	1¼	404527	404825	125	(8.6)	250	(17.3)	61	(28)
B4125S-5	B4125S-5J	1¼	404533	404572	125	(8.6)	250	(17.3)	61	(28)
B4125T-5	B4125T-5J	1¼	404539	404836	125	(8.6)	250	(17.3)	61	(28)
B4125B-5	B4125B-5J	1¼	404545	404842	125	(8.6)	250	(17.3)	61	(28)
B4125A-6	B4125A-6J	1½	404551	404848	125	(8.6)	250	(17.3)	61	(28)
B4125S-6	B4125S-6J	1½	404557	404573	125	(8.6)	250	(17.3)	61	(28)
B4125T-6	B4125T-6J	1½	404563	404859	125	(8.6)	250	(17.3)	61	(28)
B4125B-6	B4125B-6J	1½	404569	404751	125	(8.6)	250	(17.3)	61	(28)

Inverted Bucket Steam Traps (continued)

Series B BEAR TRAP®

Series B4 Ordering Information - continued

NPT Model Number	BSPT Model Number	Size in.	NPT Part Number	BSPT Part Number	Seat Differential Pressure Rating psi (bar)	Body Design Pressure psi (bar)	Weight lbs. (kg)
B4180A-4	B4180A-4J	1	404504	404802	180 (12.4)	250 (17.3)	61 (28)
B4180S-4	B4180S-4J	1	404510	404808	180 (12.4)	250 (17.3)	61 (28)
B4180T-4	B4180T-4J	1	404516	404814	180 (12.4)	250 (17.3)	61 (28)
B4180B-4	B4180B-4J	1	404522	404820	180 (12.4)	250 (17.3)	61 (28)
B4180A-5	B4180A-5J	1¼	404528	404826	180 (12.4)	250 (17.3)	61 (28)
B4180S-5	B4180S-5J	1¼	404534	404831	180 (12.4)	250 (17.3)	61 (28)
B4180T-5	B4180T-5J	1¼	404540	404837	180 (12.4)	250 (17.3)	61 (28)
B4180B-5	B4180B-5J	1¼	404546	404843	180 (12.4)	250 (17.3)	61 (28)
B4180A-6	B4180A-6J	1½	404552	404849	180 (12.4)	250 (17.3)	61 (28)
B4180S-6	B4180S-6J	1½	404558	404854	180 (12.4)	250 (17.3)	61 (28)
B4180T-6	B4180T-6J	1½	404564	404860	180 (12.4)	250 (17.3)	61 (28)
B4180B-6	B4180B-6J	1½	404570	404865	180 (12.4)	250 (17.3)	61 (28)
B4250A-4	B4250A-4J	1	404505	404803	250 (17.3)	250 (17.3)	61 (28)
B4250S-4	B4250S-4J	1	404511	404809	250 (17.3)	250 (17.3)	61 (28)
B4250T-4	B4250T-4J	1	404517	404815	250 (17.3)	250 (17.3)	61 (28)
B4250B-4	B4250B-4J	1	404523	404821	250 (17.3)	250 (17.3)	61 (28)
B4250A-5	B4250A-5J	1¼	404529	404827	250 (17.3)	250 (17.3)	61 (28)
B4250S-5	B4250S-5J	1¼	404535	404832	250 (17.3)	250 (17.3)	61 (28)
B4250T-5	B4250T-5J	1¼	404541	404838	250 (17.3)	250 (17.3)	61 (28)
B4250B-5	B4250B-5J	1¼	404547	404844	250 (17.3)	250 (17.3)	61 (28)
B4250A-6	B4250A-6J	1½	404553	404850	250 (17.3)	250 (17.3)	61 (28)
B4250S-6	B4250S-6J	1½	404559	404855	250 (17.3)	250 (17.3)	61 (28)
B4250T-6	B4250T-6J	1½	404565	404861	250 (17.3)	250 (17.3)	61 (28)
B4250B-6	B4250B-6J	1½	404571	404866	250 (17.3)	250 (17.3)	61 (28)

Inverted Bucket Steam Traps (continued)

Series B

Series B6

- Available in sizes 1½" and 2" NPT
- Maximum capacity 20,000 lbs./hr. (9072 kg/hr.)
- Meets Mil specification WW-T-696-E Type I, Style B, Class 1-7
- Completely drains condensate and air at saturation temperature
- Stainless steel internal components
- Resistant to moderate water hammer
- Bottom inlet and top outlet
- Internal parts mounted on cover for easy service
- Maximum temperature 406°F (208°C)
- Maximum pressure 250 psig (17.3 bar)

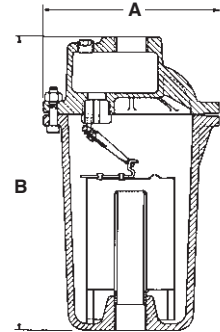

Dimensions, in. (mm)

Series	Size in.	A	B
B6	1½, 2	10 ³ / ₁₆ (258)	17 (432)

Materials of Construction	
Part	Specifications
Body and cover	Cast Iron 30,000 psi tensile
Valve Pin and Seat	Stainless Steel (Hardened)
Bucket	Stainless Steel
Lever Assembly	Stainless Steel
Cover Bolts	Grade 5 Steel

Ordering Information

Model Number	Size in.	NPT Part Number	Seat Differential Pressure Rating psi (bar)	Body Design Pressure psi (bar)	Weight lbs. (kg)
B6025A-6	1½	404690	25 (1.7)	250 (17.3)	80 (36)
B6025A-8	2	404694	25 (1.7)	250 (17.3)	80 (36)
B6040A-6	1½	404691	40 (2.8)	250 (17.3)	80 (36)
B6040A-8	2	404695	40 (2.8)	250 (17.3)	80 (36)
B6125A-6	1½	404692	125 (8.6)	250 (17.3)	80 (36)
B6125A-8	2	404696	125 (8.6)	250 (17.3)	80 (36)
B6250A-6	1½	404693	250 (17.3)	250 (17.3)	80 (36)
B6250A-8	2	404697	250 (17.3)	250 (17.3)	80 (36)

Series B  BEAR TRAP®

Capacities (Gross Ratings)

Series	Orifice Size In (mm)	Seat Pressure psi (bar)	Pressure Differential Pounds Per Square Inch (bar)																	
			1/2 (.035)	1 (0.07)	2 (0.14)	5 (0.35)	10 (0.69)	15 (1.0)	25 (1.69)	30 (2.1)	40 (2.8)	50 (3.5)	60 (4.2)	75 (5.2)	100 (6.9)	125 (8.6)	150 (10.4)	200 (13.8)	250 (17)	
			Capacity lbs./hr. (kg/hr.)																	
B6	.875 (22.2)	25 (1.69)	3930 (1784)	5250 (2383)	7330 (3327)	11000 (4994)	14100 (6396)	16300 (7394)	20000 (9072)											
	.750 (19.0)	40 (2.8)	3100 (1406)	4160 (1887)	5400 (2449)	7600 (3447)	9000 (4082)	12900 (5851)	16000 (7258)	17300 (7847)	20000 (9080)									
	.500 (12.7)	125 (8.6)	1720 (780)	2280 (1035)	3200 (1452)	4800 (2179)	6500 (2951)	7800 (3541)	9700 (4400)	10600 (4812)	12000 (5448)	13800 (6265)	14300 (6492)	15300 (6946)	18000 (8172)	20000 (9080)				
	.375 (9.53)	250 (17)	1180 (535)	1570 (712)	2200 (998)	3300 (1498)	4500 (2043)	5400 (2451)	6800 (3084)	7400 (3359)	8400 (3813)	9300 (4222)	10200 (4630)	11000 (4994)	12800 (5811)	14000 (6356)	15300 (6946)	17500 (7945)	19000 (8626)	

Thermodisc Steam Traps Series TD

The Series TD Thermodisc traps are designed for applications such as high-pressure steam drips and tracer lines, or others with light to moderate loads.

Typical applications for Thermodisc traps include:

- Drip traps on steam mains and supply lines
- Tracer lines
- Laundry and kitchen equipment
- Superheated steam applications
- Outdoor installations that are subject to freezing

Series TD Thermodisc Traps

- Stainless steel construction resists both internal and external corrosion
 - Stainless steel cast body
 - Hardened stainless steel disc is the only moving part
 - Resists water hammer
- Unaffected by superheated steam
- Simplified installation
 - Traps operate in any orientation (horizontal preferred)
 - Freeze resistant when trap is piped in vertical orientation due to self-draining design
- Easy to monitor trap operation – audible discharge cycle makes checking operation simple
- Operate over wide pressure range from 2 to 600 psig (0.14 to 41.4 bar)
- Operates with back pressure up to 80% of line pressure
- Maximum Pressure – PMO/PMA 600 psi (41.4 bar)
- Maximum Temperature – TMO/TMA 800°F (426°C)

Materials of Construction	
Part	Specifications
Body	420F Stainless Steel ASTM A743 CA40F
Cap	420 Stainless Steel ASTM A743 CA40
Disc	420 Stainless Steel ASTM A743 CA40

Series TD6520 Thermodisc Trap

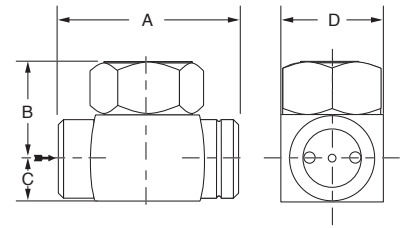

- Capacities to 4700 lbs/hr (2132 kg/hr)

Dimensions in. (mm)

Model	Size in.	A	B	C	D
TD6523	3/8	2 (51)	1 13/16 (21)	9/16 (14)	1 1/2 (38)
TD6524	1/2	2 3/4 (70)	1 3/8 (35)	5/8 (16)	1 1/2 (38)
TD6526	3/4	2 3/4 (70)	1 5/8 (41)	1 13/16 (21)	2 (51)
TD6528	1	3 1/4 (83)	1 15/16 (49)	1 5/16 (24)	2 (51)

Series TD6420 Thermodisc Trap with Integral Strainer

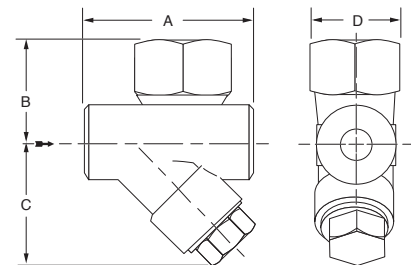

- Integral strainer to protect trap from contamination
- Capacities to 2200 lbs/hr (998 kg/hr)

Dimensions in. (mm)

Model	Size in.	A	B	C	D
TD6423	3/8	3 1/16 (78)	1 7/8 (48)	2 3/8 (60)	1 11/16 (43)
TD6424	1/2	3 1/16 (78)	1 7/8 (48)	2 3/8 (60)	1 11/16 (43)
TD6426	3/4	3 1/16 (78)	1 7/8 (48)	2 3/8 (60)	1 11/16 (43)
TD6428	1	3 3/4 (82)	2 1/8 (54)	2 1/2 (64)	1 11/16 (43)

Series 650 BEAR TRAP® (continued)
Capacities (Gross Ratings) - at 10°F Below Saturation

Model	Size in.	Pressure Differential psig (bar)													
		2 (0.14)	5 (0.35)	10 (0.69)	25 (1.7)	50 (3.5)	75 (5.2)	100 (6.9)	150 (10.4)	200 (13.8)	250 (17.3)	300 (20.7)	400 (27.6)	500 (34.5)	600 (41.4)
		Capacities in lbs./hr. (kg/hr.)													
TD6523	3/8	180 (82)	185 (84)	190 (86)	210 (95)	255 (116)	315 (143)	375 (170)	500 (227)	610 (277)	700 (318)	790 (358)	955 (433)	1105 (501)	1250 (567)
TD6524	1/2	290 (132)	310 (141)	345 (156)	440 (200)	580 (263)	710 (322)	810 (367)	995 (451)	1140 (517)	1275 (578)	1405 (637)	1630 (739)	1825 (828)	2000 (907)
TD6526	3/4	395 (179)	420 (191)	465 (211)	600 (272)	815 (370)	1000 (454)	1160 (526)	1440 (653)	1675 (760)	1895 (860)	2095 (950)	2430 (1102)	2750 (1247)	3050 (1383)
TD6528	1	620 (201)	660 (299)	730 (331)	920 (417)	1215 (551)	1490 (676)	1740 (789)	2195 (996)	2585 (1173)	2910 (1320)	3230 (1465)	3770 (1710)	4245 (1926)	4700 (2132)
TD6423	3/8			315 (143)	370 (168)	425 (193)	520 (236)	575 (261)	800 (363)	900 (408)	1080 (490)	1280 (581)	1380 (626)	1480 (671)	1650 (748)
TD6424	1/2			315 (143)	370 (168)	425 (193)	520 (236)	575 (261)	800 (363)	900 (408)	1080 (490)	1280 (581)	1380 (626)	1480 (671)	1650 (748)
TD6426	3/4			650 (295)	740 (336)	800 (363)	1000 (454)	1100 (499)	1400 (635)	1540 (699)	1630 (739)	1760 (798)	1930 (875)	2070 (939)	2200 (998)
TD6428	1			650 (295)	740 (336)	800 (363)	1000 (454)	1100 (499)	1400 (635)	1540 (699)	1630 (739)	1760 (798)	1930 (875)	2070 (939)	2200 (998)

Ordering Information

Equipped	NPT Model Number	BSPT Model Number	Size in.	NPT Part Number	BSPT Part Number	Weight lbs. (kg)
Without Strainer	TD6523	TD6523-J	3/8	405151	405159	0.8 (0.36)
	TD6524	TD6524-J	3/8	405152	405160	1.3 (0.59)
	TD6526	TD6526-J	3/4	405153	405161	2.1 (0.95)
	TD6528	TD6528-J	1	405154	405162	3.2 (1.45)
With Strainer	TD6423	TD6423-J	3/8	405155	405163	2.4 (1.1)
	TD6424	TD6424-J	1/2	405156	405164	2.4 (1.1)
	TD6426	TD6426-J	3/4	405157	405165	2.7 (1.2)
	TD6528	TD6428-J	1	405158	405166	3.3 (1.5)

Pressure and/or Temperature Pilot Operated Steam Regulators Series 2000

The Hoffman Specialty Series 2000 consists of main valves, pilot valves, wells and hardware kits. They are designed to meet a wide range of temperature, pressure and capacity requirements and provide accurate, dependable, low maintenance operation. The Series 2000 Regulators meet MIL Spec MIL-V-16733D (Type IV) and MIL-V-18433B (Type I, Style A, Class 2).

Main Valves

- Sizes available: 1/2" - 6" (150mm)
- Cast iron body with 30,000 tensile
- Maximum rating 250 psig (17.3 bar) at 450°F (232°C)
- Full, normal and reduced ports available

Pilots

- Spring • Temperature • Air • Solenoid
- Electro-Pneumatic Transducer

Basic Selection Data

Select main valve based on required sizing information.
 Select type of pilots required.
 Select hardware package based on main valve size and type of pilots used.

Example

For a 1½" Full Port Valve using a combination of temperature pilot for 50-200°F (10-93°C) range and a spring pilot with 5-60 psig (0.14-4.1 bar) range and a Normally Closed solenoid pilot...

Specify on purchase order

- 402412 Main Valve Full Port
- 400866 STPA-200 Temperature Pilot
- 400278 SPS-60 Spring Pilot
- 402255 Normally Closed Solenoid Pilot
- 400641 Hardware Kit

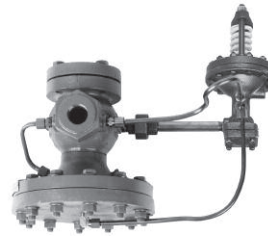

Main Valve with Pressure Control Spring Pilot



Main Valve with Temperature Control Pilot

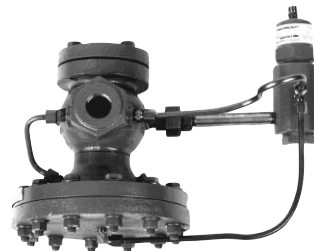

Main Valve with Pressure Control Air Pilot



Main Valve with Electric on/off Solenoid Pilot and Pressure Control Spring Pilots

***Contact your local Hoffman Specialty representative for information on Noise Silencers for Steam Regulators.**

Series 2000 Main Valves

The Series 2000 Main valve is rugged and stable in response for trouble free, dependable operation over a wide range of conditions and applications.

- For continuous or dead end service within .01% leakage of the valve's rated capacity
- Packless construction eliminates many service problems
- Complete range of port sizes:
 - Full
 - Normal
 - Reduced
 - Low pressure {Models 2150 & 2250}
- High Pressure Models 2100, 2200 & 2300
- Positive travel stop and back up of diaphragm prevents over pressurizing from low pressure side
- Maintains accurate and stable control of pressure or temperature
- Two-ply stainless steel diaphragm provides greater accuracy of control over the entire capacity range and a longer life

- Minimum differential pressure:
 - Model 2100, 2200 & 230015 psi (1.0 bar)
 - Model 2150, 22503 psi (.2 bar)
- Maximum differential pressure 150 psi (10.3 bar). A two stage reduction should be used for pressure drops greater than 150 psi (10.3 bar). Models 2150 & 2250 have maximum 30 psi differential pressure
- Maximum temperature 450°F (232°C)

Materials of Construction	
Part	Specifications
Body	Cast Iron ASTM A126-71
Stem	Stainless Steel ASTM A581, A582
Seat	Stainless Steel ASTM A582
Plug	Stainless Steel ASTM A582
Diaphragm	Stainless Steel ASTM A240
Gaskets	Non-asbestos ASTM F-104
Nuts/Bolts	ASTM A325 GRADE 5
Copper Tubing	ASTM B75 ALLOY 122

Selection Guide

Main Valve Body Styles					
Size in.	Model Number				
	2100 Screwed NPT max. pressure 250 psig (17.3 bar)	2150 Screwed NPT max. pressure 30 psig (2.1 bar)	2200 ANSI 125 Flanged max. pressure 125 psig (8.6 bar)	2250 ANSI 125 Flanged max. pressure 30 psig (2.1 bar)	2300 ANSI 250 Flanged max. pressure 250 psig (17.3 bar)
1/2	X				
3/4	X	X			
1	X	X			
1 1/4	X	X			
1 1/2	X	X			
2	X	X	X	X	X
2 1/2			X	X	X
3			X	X	X
4			X	X	X
6			X	X	X

Pressure and/or Temperature Pilot Operated Steam Regulators (continued)

**Series 2000 Main Valves
Dimensions (Main Valves)**

Model 2100 and 2150 Screwed NPT Ends — Maximum pressure 250 psig (17.3 bar)

NPT Valve Size in.	Dimensions in. (mm)			
	A	B	C	D
1/2	7 7/8 (200)	4 3/4 (121)	5 1/8 (130)	7 (178)
3/4	7 7/8 (200)	4 3/4 (121)	5 1/8 (130)	7 (178)
1	7 7/8 (200)	4 3/4 (121)	5 1/8 (130)	7 (178)
1 1/4	9 1/2 (241)	5 3/4 (146)	7 1/2 (191)	8 3/4 (222)
1 1/2	9 1/2 (241)	5 3/4 (146)	7 1/2 (191)	8 3/4 (222)
2	11 3/4 (298)	7 5/8 (194)	9 1/4 (235)	10 (254)



**Model 2100 & 2150
Screwed NPT Ends**

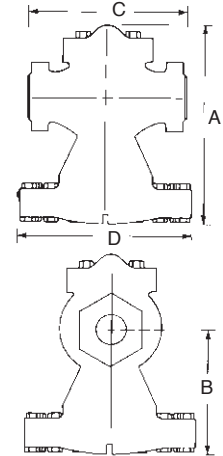

Model 2200 and 2250 Flanged Ends — Maximum pressure 125 psig (8.6 bar)

Valve Size in. (mm)	Dimensions in. (mm)					Bolt Holes		
	A	B	C	D	E	Hole Dia. in. (mm) F	No. of holes	Bolt Circ. in. (mm) G
2 (50)	11 3/4 (298)	7 5/8 (194)	8 (203)	10 (254)	5/8 (16)	3/4 (19)	4	4 3/4 (121)
2 1/2 (65)	15 5/8 (397)	9 5/8 (244)	9 5/8 (238)	12 (305)	1 1/16 (17)	3/4 (19)	4	5 1/2 (140)
3 (80)	16 3/16 (421)	10 3/16 (259)	10 (254)	13 1/8 (333)	3/4 (19)	3/4 (19)	4	6 (152)
4 (100)	19 (483)	12 (305)	11 7/8 (302)	16 5/8 (422)	1 5/16 (23.8)	3/4 (19)	8	7 1/2 (191)
6 (150)	24 3/16 (614)	15 5/8 (397)	15 1/8 (384)	22 3/4 (578)	1 (25)	7/8 (22)	8	9 1/2 (241)



**Model 2200 & 2250
Flanged Ends**

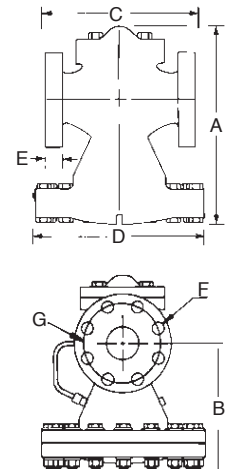

Model 2300 Flanged Ends — Maximum pressure 250 psig (17.3 bar)

Valve Size in. (mm)	Dimensions in. (mm)					Bolt Holes		
	A	B	C	D	E	Hole Dia. in. (mm) F	No. of holes	Bolt Circ. in. (mm) G
2 (50)	11 3/4 (298)	7 5/8 (194)	8 1/2 (216)	10 (254)	7/8 (22)	3/4 (19)	8	5 (127)
2 1/2 (65)	15 5/8 (397)	9 5/8 (244)	10 (254)	12 (305)	1 (25)	7/8 (22)	8	5 7/8 (149)
3 (80)	16 3/16 (421)	10 3/16 (259)	10 3/4 (273)	13 1/8 (333)	1 1/8 (29)	7/8 (22)	8	6 5/8 (168)
4 (100)	19 (483)	12 (305)	12 1/2 (318)	16 5/8 (422)	1 1/4 (32)	7/8 (22)	8	7 7/8 (200)
6 (150)	24 3/16 (614)	15 5/8 (397)	16 (406)	22 3/4 (578)	1 7/16 (37)	7/8 (22)	12	10 5/8 (270)



**Model 2300
Flanged Ends**

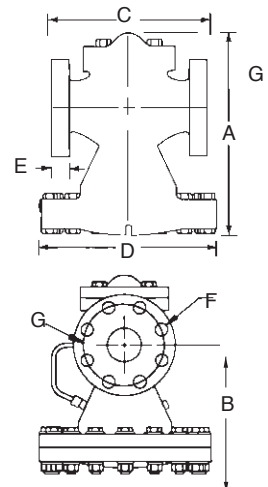

Series 2000 Main Valves
Steam Capacities — Full Port lbs./hr. (kg/hr.)
Models 2100, 2200, 2300

Pressure psig (bar)		Main Valve Size									
		NPT Size, in.					Flanged Valves, in. (mm)				
IN	OUT††	½" NPT	¾" NPT	1" NPT	1¼" NPT	1½" NPT	2" NPT/Flange	2½"(65)	3"(80)	4"(100)	6"(150)
Cv		3.9	8.3	10.6	20.2	24.2	34.2	50.3	78.7	139.6	302.2
20† (1.4)	0-5 (0-0.34)	220 (100)	260 (118)	360 (163)	660 (299)	850 (386)	1200 (544)	2020 (916)	3000 (1361)	5160 (2341)	11870 (5384)
25† (1.7)	10 (0.7)	250 (113)	300 (136)	410 (186)	800 (363)	1000 (454)	1420 (644)	2300 (1043)	3300 (1497)	6200 (2812)	14000 (6350)
	0-5 (0-0.34)	260 (118)	410 (186)	470 (213)	900 (408)	1100 (499)	1730 (785)	2900 (1315)	4000 (1814)	7000 (3175)	16300 (7394)
30† (2.1)	15 (1.0)	290 (132)	320 (145)	460 (209)	950 (431)	1100 (499)	1900 (862)	3000 (1361)	3500 (1588)	6800 (3084)	14500 (6577)
	0-10 (0-0.7)	300 (136)	460 (209)	530 (240)	1100 (499)	1240 (562)	2060 (934)	3450 (1565)	4600 (2087)	8300 (3765)	18500 (8392)
40 (2.8)	25 (1.7)	320 (145)	410 (186)	650 (295)	1200 (544)	1150 (522)	1300 (590)	3250 (1474)	3800 (1724)	7500 (3402)	17200 (7802)
	0-20 (0-1.4)	370 (168)	480 (218)	720 (327)	1250 (567)	1500 (680)	2120 (962)	3800 (1724)	4800 (2177)	9400 (4264)	19650 (8913)
50 (3.5)	35 (2.4)	370 (168)	700 (318)	770 (349)	1250 (567)	1500 (680)	2500 (1134)	3500 (1588)	4800 (2177)	9500 (4309)	20000 (9072)
	30 (2.1)	410 (186)	760 (345)	850 (386)	1550 (703)	1850 (839)	2900 (1315)	4500 (2041)	5700 (2586)	11500 (5216)	23500 (10660)
	0-25 (0-1.7)	420 (191)	800 (363)	890 (404)	1650 (748)	2050 (930)	3050 (1383)	4900 (2223)	6500 (2948)	11900 (5398)	24200 (10977)
60 (4.2)	45 (3.1)	420 (191)	760 (345)	840 (381)	1350 (612)	1700 (771)	2700 (1225)	4400 (1996)	5800 (2631)	11000 (4990)	25800 (11703)
	40 (2.8)	450 (204)	850 (386)	1000 (454)	1650 (748)	2000 (907)	3050 (1383)	4800 (2177)	6800 (3084)	13500 (6124)	27500 (12474)
	35 (2.4)	470 (213)	920 (417)	1100 (499)	1750 (794)	2200 (998)	3250 (1474)	5600 (2540)	7400 (3357)	14000 (6350)	29000 (13154)
	0-30 (0-2.1)	480 (218)	980 (445)	1140 (517)	1850 (839)	2350 (1066)	3600 (1633)	5950 (2699)	8400 (3810)	14700 (6668)	30500 (13835)
75 (5.2)	55 (3.8)	550 (249)	830 (376)	1200 (544)	2000 (907)	2300 (1043)	3750 (1701)	5800 (2631)	8500 (3856)	15100 (6849)	31000 (14062)
	50 (3.5)	570 (259)	1060 (481)	1320 (599)	2250 (1021)	2560 (1161)	3900 (1769)	6100 (2767)	8900 (4037)	16300 (7394)	34000 (15422)
	45 (3.1)	580 (263)	1120 (508)	1380 (626)	2400 (1089)	2800 (1270)	4300 (1950)	6450 (2926)	9500 (4309)	17800 (8074)	37000 (16783)
	0-40 (0-2.8)	590 (268)	1200 (544)	1400 (635)	2600 (1179)	3200 (1452)	4500 (2041)	6750 (3062)	10000 (4536)	18100 (8210)	38800 (17600)
100 (6.9)	75 (5.2)	600 (272)	1150 (522)	1480 (671)	2400 (1089)	3100 (1406)	4900 (2223)	7800 (3538)	10800 (4899)	20500 (9299)	40800 (18507)
	60 (4.2)	670 (304)	1300 (590)	1800 (816)	3000 (1361)	3900 (1769)	5350 (2427)	8900 (4037)	12200 (5534)	21750 (9866)	48000 (21773)
	0-50 (0-3.5)	690 (313)	1480 (671)	1850 (839)	3400 (1542)	4400 (1996)	5850 (2654)	9100 (4128)	13500 (6124)	22960 (10415)	50000 (22680)
125 (8.6)	100 (6.9)	650 (295)	1300 (590)	1700 (771)	3150 (1429)	3550 (1610)	5300 (2404)	8650 (3924)	12200 (5534)	22000 (9979)	49200 (22317)
	75 (5.2)	750 (340)	1700 (771)	2000 (907)	4000 (1814)	4600 (2087)	6750 (3062)	10500 (4763)	15400 (6985)	26800 (12156)	61350 (27828)
	0-50 (0-3.5)	800 (363)	1770 (803)	2100 (953)	4200 (1905)	5600 (2540)	7500 (3402)	11400 (5171)	16800 (7620)	27720 (12574)	62600 (28395)
150 (10.3)	125 (8.6)	810 (367)	1600 (726)	2050 (930)	3800 (1724)	4450 (2019)	6200 (2812)	9900 (4491)	15000 (6804)	26200 (11884)	56700 (25719)
	100 (6.9)	930 (422)	1860 (844)	2450 (1111)	4500 (2041)	5350 (2427)	7500 (3402)	11900 (5398)	17800 (8074)	31000 (14061)	69300 (31434)
	0-75 (0-5.2)	950 (431)	2100 (953)	2700 (1225)	4900 (2223)	6150 (2790)	8000 (3629)	13200 (5988)	18600 (8437)	32950 (14946)	73800 (33475)
175 (12.1)	150 (10.3)	920 (417)	1850 (839)	2250 (1021)	4100 (1860)	5000 (2268)	6900 (3130)	11400 (5171)	16100 (7303)	28940 (13127)	63600 (28849)
	125 (8.6)	1050 (476)	2150 (975)	2700 (1225)	5000 (2268)	6200 (2812)	8600 (3901)	13300 (6033)	20220 (9172)	34800 (15785)	77000 (24927)
	100 (6.9)	1100 (499)	2280 (1034)	3000 (1361)	5500 (2495)	6900 (3130)	9500 (4309)	14700 (6668)	21900 (9934)	37500 (17010)	85000 (38556)
	0-75 (0-5.2)	1150 (522)	2400 (1089)	3100 (1406)	5800 (2631)	7400 (3357)	9750 (4423)	15600 (7076)	22070 (10011)	38000 (17237)	86000 (39010)
200 (13.8)	150 (10.3)	1130 (513)	2400 (1089)	2850 (1293)	5500 (2495)	6700 (3039)	9200 (4173)	14400 (6532)	22440 (10179)	38000 (17237)	84600 (38375)
	125 (8.6)	1200 (544)	2600 (1179)	3200 (1452)	6000 (2722)	7600 (3447)	10450 (4740)	15600 (7076)	25170 (11417)	43000 (19505)	95900 (43500)
	0-100 (0-6.9)	1250 (567)	2680 (1216)	3400 (1542)	6500 (2948)	7800 (3538)	11000 (4990)	16200 (7348)	25340 (11494)	43350 (19664)	97330 (44149)
225 (15.5)	175 (12.1)	1260 (572)	2480 (1125)	3080 (1397)	5980 (2713)	7180 (3257)	10150 (4604)	15850 (7189)	24300 (11022)	41221 (18697)	91600 (41549)
	150 (10.3)	1370 (621)	2790 (1266)	3540 (1606)	6840 (3103)	8370 (3797)	11600 (5262)	17770 (8060)	27250 (12360)	46200 (20956)	104600 (47446)
	0-125 (0-8.6)	1430 (649)	3000 (1361)	3770 (1710)	7200 (3266)	9120 (4137)	12200 (5534)	18450 (8368)	28300 (12836)	47980 (21763)	108600 (49260)
250 (17.3)	200 (13.8)	1350 (612)	2670 (1211)	3250 (1474)	6480 (2939)	7340 (3329)	10920 (4953)	17050 (7734)	20400 (9253)	44330 (20108)	98500 (44680)
	175 (12.1)	1480 (671)	3000 (1361)	3700 (1678)	7350 (3334)	8650 (3924)	12370 (5611)	19100 (8664)	29250 (13268)	49600 (22499)	112400 (50985)
	150 (10.3)	1550 (703)	3250 (1474)	4150 (1882)	7970 (3615)	9650 (4377)	13360 (6060)	20400 (9253)	31250 (14175)	53000 (24041)	120000 (54432)
	0-125 (0-8.6)	1550 (703)	3280 (1488)	4300 (1950)	8050 (3651)	9960 (4518)	13720 (6223)	20400 (9253)	31250 (14175)	53000 (24041)	120000 (54432)

Note: Capacity based on saturated steam at valve inlet. Pressure differential must be at least 15 psi (6.9 bar) for valve to operate.

†For inlet pressures below 30 psig (2.1 bar), refer to the Low Pressure Steam Capacity Chart, Models 2150 and 2250, page 48.

††When the outlet steam pressure is 50% or less of the inlet pressure, always use the lowest outlet pressure shown in the capacity table.

Series 2000 Main Valves

Steam Capacities — Normal Port lbs./hr. (kg/hr.)

Models 2100, 2200, 2300

Regulators

		Main Valve Size									
Pressure psig (bar)		NPT Size, in.					Flanged Valves, in. (mm)				
IN	OUT††	½"NPT	¾"NPT	1"NPT	1¼"NPT	1½"NPT	2"NPT/Flange	2½"(65)	3"(80)	4"(100)	6"(150)
Cv		2.7	5.9	8.3	16.2	20.2	26.7	38.5	66.7	95.8	239.4
20† (1.4)	0-5 (0-0.34)	140 (64)	260 (118)	280 (127)	620 (281)	660 (299)	980 (445)	1480 (671)	2370 (1075)	3860 (1751)	9500 (4309)
25† (1.7)	10 (0.7)	160 (73)	300 (136)	300 (136)	700 (318)	800 (363)	1140 (517)	1700 (771)	2750 (1247)	4500 (2041)	10930 (4958)
	0-5 (0-0.34)	165 (75)	400 (181)	410 (186)	780 (354)	900 (408)	1290 (585)	1900 (862)	3600 (1633)	5100 (2313)	12900 (5851)
30† (2.1)	15 (1.0)	175 (79)	320 (145)	430 (195)	800 (363)	950 (431)	1250 (567)	1950 (885)	3100 (1406)	4800 (2177)	12500 (5670)
	0-10 (0-0.7)	185 (84)	460 (209)	460 (209)	920 (417)	1100 (499)	1530 (694)	2450 (1111)	4200 (1905)	5800 (2631)	14700 (6668)
40 (2.8)	25 (1.7)	200 (91)	360 (163)	410 (186)	950 (431)	1200 (544)	1550 (703)	2200 (998)	3650 (1656)	5600 (2540)	14000 (6350)
	0-20 (0-1.4)	221 (100)	480 (218)	480 (218)	1150 (522)	1250 (567)	1750 (794)	2600 (1179)	4100 (1860)	7000 (3175)	17500 (7938)
50 (3.5)	35 (2.4)	238 (108)	480 (218)	700 (318)	1150 (522)	1250 (567)	1950 (885)	2350 (1066)	4500 (2041)	5900 (2676)	16300 (7394)
	30 (2.1)	250 (113)	530 (240)	760 (345)	1400 (635)	1550 (703)	2100 (953)	2900 (1315)	5300 (2404)	7300 (3311)	19500 (8845)
	0-25 (0-1.7)	266 (121)	580 (263)	800 (363)	1460 (662)	1650 (748)	2400 (1089)	3500 (1588)	5600 (2540)	8400 (3810)	21200 (9616)
60 (4.2)	45 (3.1)	275 (125)	530 (240)	760 (345)	1300 (590)	1350 (612)	2100 (953)	3150 (1429)	4750 (2155)	8200 (3720)	18600 (8437)
	40 (2.8)	288 (131)	610 (277)	850 (386)	1600 (726)	1650 (748)	2300 (1043)	3600 (1633)	5500 (2495)	8700 (3946)	21500 (9752)
	35 (2.4)	310 (141)	660 (299)	920 (417)	1720 (780)	1750 (794)	2600 (1179)	3800 (1724)	6300 (2858)	9300 (4218)	22800 (10342)
	0-30 (0-2.1)	320 (145)	680 (308)	980 (445)	1820 (826)	1850 (839)	2700 (1225)	4200 (1905)	6900 (3130)	9900 (4491)	25500 (11567)
75 (5.2)	55 (3.8)	335 (152)	720 (327)	830 (376)	1990 (903)	2000 (907)	2850 (1293)	4150 (1882)	6700 (3039)	10200 (4627)	26200 (11884)
	50 (3.5)	351 (159)	750 (340)	1060 (481)	2030 (921)	2250 (1021)	3100 (1406)	4450 (2019)	7500 (3402)	10800 (4899)	28000 (12701)
	45 (3.1)	370 (168)	800 (363)	1120 (508)	2120 (962)	2400 (1089)	3350 (1520)	4700 (2132)	7800 (3538)	11900 (5398)	29000 (13154)
	0-40 (0-2.8)	385 (175)	860 (390)	1300 (590)	2200 (998)	2600 (1179)	3550 (1610)	4900 (2223)	8000 (3629)	12100 (5489)	31450 (14266)
100 (6.9)	75 (5.2)	440 (200)	900 (408)	1150 (522)	2450 (1111)	2500 (1134)	3700 (1678)	5300 (2404)	8700 (3946)	13200 (5988)	33000 (14969)
	60 (4.2)	460 (209)	980 (445)	1300 (590)	2750 (1247)	3000 (1361)	4650 (2109)	6000 (2722)	10000 (4536)	15200 (6895)	38000 (17237)
	0-50 (0-3.5)	475 (215)	1000 (454)	1480 (671)	2880 (1306)	3400 (1542)	4700 (2132)	6550 (2971)	10700 (4854)	16000 (7258)	39300 (17826)
125 (8.6)	100 (6.9)	525 (238)	1000 (454)	1300 (590)	2700 (1225)	3150 (1429)	4200 (1905)	6250 (2835)	10200 (4627)	15000 (6804)	38300 (17373)
	75 (5.2)	545 (247)	1200 (544)	1700 (771)	3250 (1474)	4000 (1814)	5400 (2449)	7600 (3447)	12500 (5670)	18300 (8301)	48900 (22181)
	0-50 (0-3.5)	570 (259)	1230 (558)	1770 (803)	3400 (1542)	4200 (1905)	5850 (2654)	8350 (3788)	13400 (6078)	19700 (8936)	50200 (22771)
150 (10.3)	125 (8.6)	565 (256)	1200 (544)	1600 (726)	3250 (1474)	3800 (1724)	5150 (2336)	7500 (3402)	11800 (5352)	17200 (7802)	44000 (19958)
	100 (6.9)	660 (299)	1400 (635)	1860 (844)	3850 (1746)	4500 (2041)	6300 (2858)	8650 (3924)	14400 (6532)	20800 (9435)	55600 (25220)
	0-75 (0-5.2)	680 (308)	1480 (671)	2100 (953)	4000 (1814)	4900 (2223)	6800 (3084)	9500 (4309)	15600 (7076)	22800 (10342)	59200 (26853)
175 (12.1)	150 (10.3)	636 (288)	1400 (635)	1850 (839)	3600 (1633)	4100 (1860)	5900 (2676)	8250 (3742)	13600 (6169)	18800 (8528)	49500 (22453)
	125 (8.6)	755 (342)	1570 (712)	2150 (975)	4360 (1978)	5000 (2268)	7000 (3175)	9700 (4400)	16650 (7552)	23200 (10524)	61000 (27670)
	100 (6.9)	800 (363)	1640 (744)	2280 (1034)	4600 (2087)	5500 (2495)	7600 (3447)	10600 (4808)	18500 (8392)	26000 (11794)	68000 (30845)
	0-75 (0-5.2)	810 (367)	1680 (762)	2400 (1089)	4650 (2109)	5800 (2631)	7900 (3583)	11250 (5103)	18820 (8537)	27200 (12338)	68300 (30981)
200 (13.8)	150 (10.3)	815 (370)	1650 (748)	2400 (1089)	4600 (2087)	5500 (2495)	7700 (3493)	10700 (4854)	18540 (8410)	25700 (11658)	66700 (30255)
	125 (8.6)	865 (392)	1850 (839)	2600 (1179)	5000 (2268)	6000 (2722)	8400 (3810)	11800 (5352)	21150 (9594)	29900 (13563)	76600 (34746)
	0-100 (0-6.9)	880 (399)	1900 (862)	2680 (1216)	5200 (2359)	6500 (2948)	8600 (3901)	12400 (5625)	21490 (9748)	30850 (13994)	77100 (34973)
225 (15.5)	175 (12.1)	910 (413)	1750 (794)	2480 (1125)	5150 (2336)	5980 (2713)	8260 (3747)	11800 (5352)	20080 (9108)	28200 (12792)	72220 (32759)
	150 (10.3)	983 (446)	2000 (907)	2790 (1266)	5730 (2599)	6840 (3103)	9250 (4196)	13420 (6087)	22900 (10387)	32370 (14683)	81700 (37059)
	0-125 (0-8.6)	1020 (463)	2050 (930)	3000 (1361)	5950 (2699)	7200 (3266)	9640 (4373)	14150 (6418)	24000 (10886)	34440 (15622)	86100 (39055)
250 (17.3)	200 (13.8)	980 (445)	1520 (689)	2670 (1211)	5500 (2495)	6480 (2939)	8850 (4014)	12890 (5947)	21970 (9966)	30300 (13744)	77660 (35227)
	175 (12.1)	1080 (490)	1880 (853)	3000 (1361)	6150 (2790)	7350 (3334)	9900 (4491)	14600 (6623)	25600 (11612)	34760 (15767)	87750 (39803)
	150 (10.3)	1130 (513)	2150 (975)	3250 (1474)	6600 (2994)	7970 (3615)	10640 (4826)	15620 (7085)	26250 (11907)	37500 (17010)	94600 (42911)
	0-125 (0-8.6)	1140 (517)	2250 (1021)	3280 (1488)	6650 (3016)	8050 (3651)	10680 (4844)	15750 (7144)	26500 (12020)	38000 (17237)	95000 (43092)

Note: Capacity based on saturated steam at valve inlet. Pressure differential must be at least 15 psi (6.9 bar) for valve to operate.

†For inlet pressures below 30 psig (2.1 bar), refer to the Low Pressure Steam Capacity Chart, Models 2150 and 2250, page 48.

††When the outlet steam pressure is 50% or less of the inlet pressure, always use the lowest outlet pressure shown in the capacity table.

Series 2000 Main Valves
Steam Capacities — Reduced Port lbs./hr. (kg/hr.)
Models 2100, 2200, 2300

		Main Valve Size									
Pressure psig (bar)		NPT Size, in.					Flanged Valves, in. (mm)				
IN	OUT††	½"NPT	¾"NPT	1"NPT	1¼"NPT	1½"NPT	2"NPT/Flange	2½"(65)	3"(80)	4"(100)	6"(150)
Cv		1.0	3.9	5.9	10.6	16.2	21.1	28.3	41.3	70.2	163
20† (1.4)	0-5 (0-0.34)	50 (23)	220 (100)	280 (127)	480 (218)	620 (281)	860 (390)	1360 (617)	1840 (835)	3090 (1402)	7120 (3230)
25† (1.7)	10 (0.7)	57 (26)	250 (113)	300 (136)	550 (249)	700 (317)	970 (439)	1560 (708)	2100 (953)	3670 (1665)	8200 (3720)
	0-5 (0-0.34)	58 (26)	260 (118)	400 (181)	620 (281)	780 (353)	1080 (489)	1630 (739)	2240 (1016)	3940 (1787)	8500 (3856)
30† (2.1)	15 (1.0)	62 (28)	290 (132)	430 (195)	700 (318)	800 (363)	1100 (499)	1710 (776)	2400 (1089)	4000 (1814)	9500 (4309)
	0-10 (0-0.7)	65 (29)	300 (136)	460 (209)	780 (354)	920 (417)	1180 (535)	1835 (832)	2520 (1143)	4500 (2041)	10170 (4613)
40 (2.8)	25 (1.7)	72 (33)	320 (145)	360 (163)	730 (331)	950 (431)	1260 (572)	2050 (930)	2500 (1134)	4650 (2109)	10000 (4536)
	0-20 (0-1.4)	78 (35)	370 (168)	480 (218)	840 (381)	1150 (522)	1380 (626)	2250 (1021)	3000 (1361)	5400 (2449)	11500 (5216)
50 (3.5)	35 (2.4)	81 (37)	370 (168)	480 (218)	900 (408)	1150 (522)	1450 (658)	2300 (1043)	3200 (1452)	5200 (2359)	11100 (5035)
	30 (2.1)	93 (42)	410 (185)	530 (240)	1050 (476)	1400 (635)	1680 (762)	2700 (1225)	3520 (1597)	6100 (2767)	13000 (5897)
	0-25 (0-1.7)	100 (45)	420 (190)	580 (263)	1100 (499)	1460 (662)	1800 (816)	2800 (1270)	3700 (1678)	6640 (3012)	14000 (6350)
60 (4.2)	45 (3.1)	95 (43)	420 (191)	530 (240)	1000 (453)	1300 (590)	1650 (748)	2650 (1202)	3350 (1520)	5800 (2631)	14000 (6350)
	40 (2.8)	104 (47)	450 (204)	610 (277)	1100 (499)	1600 (726)	1850 (839)	3000 (1361)	3860 (1751)	6800 (3084)	15200 (6895)
	35 (2.4)	111 (50)	470 (213)	660 (299)	1150 (522)	1720 (780)	1970 (894)	3150 (1429)	4200 (1905)	7300 (3311)	15800 (7167)
	0-30 (0-2.1)	115 (52)	480 (218)	680 (308)	1200 (544)	1820 (826)	2200 (998)	3300 (1497)	4450 (2019)	7800 (3538)	17100 (7757)
75 (5.2)	55 (3.8)	118 (53)	550 (249)	720 (327)	1350 (612)	1900 (862)	2150 (975)	3400 (1542)	4800 (2177)	8000 (3629)	16200 (7348)
	50 (3.5)	127 (57)	570 (259)	750 (340)	1400 (635)	2030 (921)	2400 (1089)	3500 (1588)	5050 (2291)	8500 (3856)	16700 (7575)
	45 (3.1)	134 (60)	580 (264)	800 (363)	1430 (649)	2120 (962)	2550 (1157)	3650 (1656)	5300 (2404)	9100 (4128)	17800 (8074)
	0-40 (0-2.8)	138 (62)	590 (268)	860 (390)	1450 (658)	2200 (998)	2650 (1202)	3750 (1701)	5520 (2504)	9300 (4218)	20000 (9072)
100 (6.9)	75 (5.2)	151 (68)	600 (272)	900 (408)	1740 (789)	2450 (1111)	3100 (1406)	4300 (1950)	6200 (2812)	10400 (4717)	21200 (9616)
	60 (4.2)	174 (78)	670 (304)	990 (449)	1830 (830)	2750 (1247)	3450 (1565)	5000 (2268)	7000 (3175)	11300 (5126)	25000 (11340)
	0-50 (0-3.5)	177 (80)	690 (312)	1000 (454)	1870 (848)	2880 (1306)	3600 (1633)	5100 (2313)	7300 (3311)	11970 (5430)	27000 (12247)
125 (8.6)	100 (6.9)	175 (79)	650 (295)	1000 (453)	1900 (862)	2700 (1225)	3350 (1520)	4950 (2245)	7000 (3175)	12000 (5443)	24000 (10886)
	75 (5.2)	213 (97)	750 (340)	1200 (544)	2150 (975)	3250 (1474)	4300 (1950)	6000 (2722)	8350 (3788)	14000 (6350)	30000 (13608)
	0-50 (0-3.5)	215 (98)	800 (363)	1230 (558)	2200 (998)	3400 (1542)	4400 (1996)	6100 (2767)	8700 (3946)	14600 (6623)	32200 (14606)
150 (10.3)	125 (8.6)	198 (90)	810 (367)	1200 (544)	2300 (1043)	3250 (1474)	4100 (1860)	5750 (2608)	8000 (3629)	13600 (6169)	27800 (12610)
	100 (6.9)	240 (109)	930 (422)	1400 (635)	2750 (1247)	3850 (1746)	4800 (2177)	6900 (3130)	9500 (4309)	16300 (7399)	35700 (16194)
	0-75 (0-5.2)	254 (115)	950 (431)	1480 (671)	2760 (1252)	4000 (1814)	5200 (2359)	7100 (3221)	10400 (4717)	17200 (7802)	39500 (17917)
175 (12.1)	150 (10.3)	220 (100)	920 (417)	1400 (635)	2600 (1179)	3600 (1633)	4500 (2041)	6600 (2994)	9300 (4218)	15300 (6940)	31150 (14129)
	125 (8.6)	226 (103)	1050 (476)	1570 (712)	3000 (1361)	4360 (1978)	5320 (2413)	7600 (3447)	10800 (4898)	18200 (8255)	40150 (18212)
	100 (6.9)	290 (132)	1100 (499)	1640 (744)	3100 (1406)	4600 (2087)	5800 (2631)	7900 (3583)	11700 (5307)	19960 (9053)	45700 (20729)
	0-75 (0-5.2)	295 (134)	1150 (522)	1680 (762)	3200 (1452)	4650 (2109)	5800 (2631)	8000 (3629)	11750 (5329)	20100 (9117)	46400 (21047)
200 (13.8)	150 (10.3)	291 (132)	1130 (513)	1650 (748)	3100 (1406)	4600 (2087)	5800 (2630)	8400 (3810)	11380 (5162)	16900 (7666)	44500 (20185)
	125 (8.6)	327 (148)	1200 (544)	1850 (839)	3250 (1474)	5000 (2268)	6500 (2948)	9100 (4128)	13100 (5942)	20100 (9117)	52200 (23678)
	0-100 (0-6.9)	330 (150)	1250 (567)	1900 (862)	3300 (1497)	5200 (2359)	6800 (3084)	9100 (4128)	13300 (6033)	22600 (10251)	52500 (23814)
225 (15.5)	175 (12.1)	315 (143)	1260 (572)	1750 (794)	3150 (1429)	5150 (2336)	6400 (2903)	8800 (3992)	12330 (5593)	21500 (9752)	45800 (20775)
	150 (10.3)	355 (161)	1370 (621)	2000 (907)	3650 (1656)	5730 (2599)	7150 (3243)	9870 (4477)	14000 (6350)	24080 (10923)	53300 (24177)
	0-125 (0-8.6)	370 (168)	1430 (649)	2050 (930)	4020 (1823)	5950 (2699)	7500 (3402)	10300 (4672)	14760 (6695)	25400 (11521)	58640 (26599)
250 (17.2)	200 (13.8)	339 (154)	1350 (612)	1880 (853)	3400 (1542)	5500 (2495)	6850 (3107)	9090 (4123)	13260 (6015)	23110 (10483)	50400 (22861)
	175 (12.1)	380 (172)	1480 (671)	2150 (975)	3970 (1801)	6150 (2799)	7680 (3483)	10400 (4717)	15050 (6827)	25860 (11730)	58500 (26536)
	150 (10.3)	405 (184)	1550 (703)	2250 (1021)	4440 (2014)	6600 (2994)	8300 (3765)	11300 (5126)	16300 (7394)	27800 (12610)	63400 (28758)
	0-125 (0-8.6)	410 (186)	1550 (703)	2250 (1021)	4500 (2041)	6650 (3016)	8330 (3778)	11360 (5153)	16400 (7439)	28100 (12746)	64300 (29166)

Note: Capacity based on saturated steam at valve inlet. Pressure differential must be at least 15 psi (6.9 bar) for valve to operate.
 †For inlet pressures below 30 psig (2.1 bar), refer to the Low Pressure Steam Capacity Chart, Models 2150 and 2250, page 48.
 ††When the outlet steam pressure is 50% or less of the inlet pressure, always use the lowest outlet pressure shown in the capacity table.

Series 2000 Main Valves

Steam Capacities – Low Pressure lbs./hr. (kg/hr.)

Models 2150, 2250

Regulators

		Main Valve Size								
Pressure psig (bar)		NPT Size, in.					Flanged Valves, in. (mm)			
IN	OUT†	¾"NPT	1"NPT	1¼"NPT	1½"NPT	2"NPT/Flange	2½"(65)	3"(80)	4"(100)	6"(150)
Cv		6.1	10.5	21.5	26.8	43	53.2	63.8	127.1	347.9
5 (.35)	2 (.14)	100 (45)	200 (91)	450 (204)	500 (227)	750 (340)	950 (431)	1050 (476)	2350 (1066)	7600 (3447)
	0-1 (0-.07)	140 (64)	240 (109)	490 (222)	550 (249)	850 (386)	1075 (488)	1200 (544)	2500 (1134)	7700 (3493)
6 (.42)	3 (.21)	105 (48)	210 (95)	470 (213)	540 (245)	800 (363)	1075 (488)	1150 (522)	2400 (1089)	7700 (3493)
	0-1 (0-.07)	160 (73)	295 (134)	540 (245)	660 (299)	1050 (476)	1200 (544)	1350 (612)	2600 (1179)	8000 (3629)
7 (.49)	4 (.28)	115 (52)	215 (98)	485 (220)	570 (259)	870 (395)	1150 (522)	1300 (590)	2450 (1111)	7900 (3583)
	0-2 (0-.14)	175 (79)	325 (147)	560 (254)	760 (345)	1200 (544)	1300 (590)	1500 (680)	2800 (1270)	8300 (3765)
8 (.56)	5 (.35)	120 (54)	220 (100)	500 (227)	600 (272)	940 (426)	1200 (544)	1400 (635)	2550 (1157)	8150 (3697)
	0-3 (0-.21)	180 (82)	340 (154)	630 (286)	800 (363)	1250 (567)	1350 (612)	1550 (703)	3250 (1474)	9243 (4192)
9 (.62)	6 (.42)	125 (57)	230 (104)	520 (236)	630 (286)	1000 (454)	1350 (612)	1550 (703)	2800 (1270)	8400 (3810)
	4 (.28)	190 (86)	350 (159)	650 (295)	815 (370)	1320 (599)	1500 (680)	1800 (816)	3350 (1520)	9600 (4355)
	0-2 (0-.14)	230 (104)	405 (184)	720 (327)	940 (426)	1500 (680)	1600 (726)	1900 (862)	3550 (1610)	9700 (4400)
10 (0.7)	7 (.49)	130 (59)	240 (109)	540 (245)	670 (304)	1050 (476)	1500 (680)	1650 (748)	3000 (1361)	10300 (4672)
	5 (.35)	200 (91)	350 (159)	730 (331)	860 (390)	1400 (635)	1750 (794)	1900 (862)	3450 (1565)	11300 (5126)
	0-2 (0-.14)	250 (113)	420 (191)	820 (372)	1040 (472)	1600 (726)	1800 (816)	2100 (953)	3600 (1633)	12000 (5443)
12 (.83)	9 (.62)	140 (64)	250 (113)	570 (259)	700 (318)	1100 (499)	1750 (794)	1800 (816)	3300 (1497)	10700 (4854)
	7 (.49)	210 (95)	360 (163)	750 (340)	800 (363)	1460 (662)	2000 (907)	2300 (1043)	3600 (1633)	11200 (5080)
	5 (.35)	250 (113)	410 (186)	900 (408)	1050 (476)	1700 (771)	2150 (975)	2650 (1202)	4000 (1814)	12000 (5443)
	0-2 (0-.14)	300 (136)	480 (218)	940 (426)	1200 (544)	1850 (839)	2300 (1043)	2700 (1225)	4400 (1996)	12500 (5670)
15 (6.9)	12 (.83)	150 (68)	270 (122)	600 (272)	740 (336)	1170 (531)	1800 (816)	1900 (862)	3600 (1633)	11000 (4990)
	10 (.7)	215 (98)	385 (175)	800 (363)	920 (417)	1500 (680)	2250 (1021)	2550 (1157)	4200 (1905)	12500 (5670)
	8 (.56)	260 (118)	450 (204)	940 (426)	1100 (499)	1750 (794)	2400 (1089)	2900 (1315)	4800 (2177)	14000 (6350)
	5 (.35)	315 (143)	510 (231)	1000 (454)	1250 (567)	2020 (916)	2550 (1157)	3200 (1452)	5400 (2449)	14300 (6486)
0-2.5 (0-.17)	345 (156)	540 (245)	1040 (472)	1360 (617)	2200 (998)	2600 (1179)	3300 (1497)	6000 (2722)	14500 (6577)	
20 (1.4)	17 (1.2)	160 (73)	290 (132)	640 (290)	800 (363)	1300 (590)	1450 (658)	2000 (907)	3800 (1724)	14000 (6350)
	15 (1.0)	220 (100)	400 (181)	835 (379)	1140 (517)	1850 (839)	2000 (907)	3100 (1406)	5000 (2268)	16000 (7258)
	10 (.7)	360 (163)	600 (272)	1150 (522)	1420 (644)	2300 (1043)	2500 (1134)	3950 (1792)	7200 (3266)	16500 (7484)
	0-5 (0-.35)	400 (181)	670 (304)	1250 (567)	1630 (739)	2650 (1202)	2650 (1202)	4550 (2064)	7300 (3311)	17000 (7711)
25 (1.7)	22 (1.5)	170 (77)	320 (145)	670 (304)	870 (395)	1400 (635)	1750 (794)	2200 (998)	4000 (1814)	12000 (5443)
	20 (1.4)	230 (104)	420 (191)	865 (392)	1100 (499)	1800 (816)	2400 (1089)	3300 (1497)	6000 (2722)	14000 (6350)
	15 (1.0)	335 (160)	650 (295)	1215 (551)	1490 (676)	2400 (1089)	2700 (1225)	4000 (1814)	8200 (3720)	16500 (7484)
	10 (.7)	430 (195)	720 (327)	1325 (601)	1700 (771)	2800 (1270)	3000 (1361)	4600 (2087)	8300 (3765)	19500 (8845)
	0-5 (0-.35)	460 (209)	770 (349)	1380 (626)	1900 (862)	3100 (1406)	3200 (1452)	5000 (2268)	8300 (3765)	20000 (9072)
30 (2.1)	27 (1.9)	180 (82)	330 (150)	690 (313)	935 (424)	1500 (680)	2000 (907)	2200 (998)	4200 (1905)	12500 (5670)
	25 (1.7)	240 (109)	430 (195)	885 (401)	1225 (556)	1900 (862)	2450 (1111)	3380 (1533)	7020 (3184)	14700 (6668)
	20 (1.4)	375 (170)	670 (304)	1250 (567)	1550 (703)	2500 (1134)	2750 (1247)	4070 (1846)	8800 (3992)	17300 (7847)
	15 (1.0)	450 (204)	760 (345)	1375 (624)	1770 (803)	2950 (1338)	3150 (1429)	4660 (2114)	9080 (4119)	20000 (9072)
	0-10 (0-.7)	520 (236)	870 (395)	1575 (714)	2100 (953)	3400 (1542)	3600 (1633)	5480 (2486)	9300 (4218)	21300 (9662)

Capacity based on saturated steam at valve inlet. Maximum inlet pressure 30 psi (2.1 bar).

Capacity based on 1 psi (.07 bar) accuracy of control. Pressure differential must be at least 3 psi (.21 bar) in order for valve to operate.

Series 2000 Main Valve Ordering Information

Series 2000 main valves, pilots, wells, and hardware kits **MUST BE ORDERED** as separate line items.

Model Number	Part Number	Size in. (mm)	Port	End Connections	Maximum Pressure psig (bar)	Weight lbs. (kg)
2100	402439	½ NPT	Full	Screwed NPT	250 (17.3)	23 (10.4)
2100	402436	½ NPT	Normal	Screwed NPT	250 (17.3)	23 (10.4)
2100	402433	½ NPT	Reduced	Screwed NPT	250 (17.3)	23 (10.4)
2100	402442	¾ NPT	Full	Screwed NPT	250 (17.3)	23 (10.4)
2100	402457	¾ NPT	Normal	Screwed NPT	250 (17.3)	23 (10.4)
2100	402460	¾ NPT	Reduced	Screwed NPT	250 (17.3)	23 (10.4)
2100	402445	1 NPT	Full	Screwed NPT	250 (17.3)	23 (10.4)
2100	402463	1 NPT	Normal	Screwed NPT	250 (17.3)	23 (10.4)
2100	402466	1 NPT	Reduced	Screwed NPT	250 (17.3)	23 (10.4)
2100	402409	1¼ NPT	Full	Screwed NPT	250 (17.3)	44 (20)
2100	402469	1¼ NPT	Normal	Screwed NPT	250 (17.3)	44 (20)
2100	402472	1¼ NPT	Reduced	Screwed NPT	250 (17.3)	44 (20)
2100	402412	1½ NPT	Full	Screwed NPT	250 (17.3)	44 (20)
2100	402475	1½ NPT	Normal	Screwed NPT	250 (17.3)	44 (20)
2100	402478	1½ NPT	Reduced	Screwed NPT	250 (17.3)	44 (20)
2100	402448	2 NPT	Full	Screwed NPT	250 (17.3)	64 (29)
2100	402451	2 NPT	Normal	Screwed NPT	250 (17.3)	64 (29)
2100	402454	2 NPT	Reduced	Screwed NPT	250 (17.3)	64 (29)
2200	402592	2 (50)	Full	Flanged	125 (8.6)	67 (30)
2200	402595	2 (50)	Normal	Flanged	125 (8.6)	67 (30)
2200	402598	2 (50)	Reduced	Flanged	125 (8.6)	67 (30)
2200	402541	2½ (65)	Full	Flanged	125 (8.6)	175 (79)
2200	402544	2½ (65)	Normal	Flanged	125 (8.6)	175 (79)
2200	402547	2½ (65)	Reduced	Flanged	125 (8.6)	175 (79)
2200	402523	3 (80)	Full	Flanged	125 (8.6)	215 (98)
2200	402526	3 (80)	Normal	Flanged	125 (8.6)	215 (98)
2200	402529	3 (80)	Reduced	Flanged	125 (8.6)	215 (98)
2200	402505	4 (100)	Full	Flanged	125 (8.6)	297 (135)
2200	402508	4 (100)	Normal	Flanged	125 (8.6)	297 (135)
2200	402511	4 (100)	Reduced	Flanged	125 (8.6)	297 (135)
2200	402487	6 (150)	Full	Flanged	125 (8.6)	535 (243)
2200	402490	6 (150)	Normal	Flanged	125 (8.6)	535 (243)
2200	402493	6 (150)	Reduced	Flanged	125 (8.6)	535 (243)
2300	402601	2 (50)	Full	Flanged	250 (17.3)	70 (32)
2300	402604	2 (50)	Normal	Flanged	250 (17.3)	70 (32)
2300	402607	2 (50)	Reduced	Flanged	250 (17.3)	70 (32)
2300	402532	2½ (65)	Full	Flanged	250 (17.3)	181 (82)
2300	402535	2½ (65)	Normal	Flanged	250 (17.3)	181 (82)
2300	402538	2½ (65)	Reduced	Flanged	250 (17.3)	181 (82)
2300	402514	3 (80)	Full	Flanged	250 (17.3)	221 (100)
2300	402517	3 (80)	Normal	Flanged	250 (17.3)	221 (100)
2300	402520	3 (80)	Reduced	Flanged	250 (17.3)	221 (100)
2300	402496	4 (100)	Full	Flanged	250 (17.3)	305 (138)
2300	402499	4 (100)	Normal	Flanged	250 (17.3)	305 (138)
2300	402502	4 (100)	Reduced	Flanged	250 (17.3)	305 (138)
2300	402481	6 (150)	Full	Flanged	250 (17.3)	552 (250)
2300	400185	6 (150)	Normal	Flanged	250 (17.3)	552 (250)
2300	402484	6 (150)	Reduced	Flanged	250 (17.3)	552 (250)
2150	402664	¾ NPT	NA	Screwed NPT	30 (2.1)	22.5 (10.2)
2150	402667	1 NPT	NA	Screwed NPT	30 (2.1)	22.5 (10.2)
2150	402649	1¼ NPT	NA	Screwed NPT	30 (2.1)	42 (19)
2150	402652	1½ NPT	NA	Screwed NPT	30 (2.1)	42 (19)
2150	402655	2 NPT	NA	Screwed NPT	30 (2.1)	62 (28)
2250	402658	2 (50)	NA	Flanged	30 (2.1)	67 (30)
2250	400751	2½ (65)	NA	Flanged	30 (2.1)	175 (79)
2250	400752	3 (80)	NA	Flanged	30 (2.1)	215 (98)
2250	400754	4 (100)	NA	Flanged	30 (2.1)	297 (135)
2250	400757	6 (150)	NA	Flanged	30 (2.1)	535 (243)

Hardware Kit Ordering Information

One kit per main valve is required to connect the pilot valve(s).

Part Number	Description	Size in.	Wt. (Approx.) lbs. (kg)
400638	Kit used when main valve has temperature or solenoid pilots only	½ - 2 NPT and 2" (50mm)	2 (1.0)
400640	Kit used when main valve has temperature or solenoid pilots only	2½ - 6 (65 - 150mm)	4 (2.0)
400641	Kit used when main valve has a spring or air pressure pilot or in combination with temperature or solenoid pilots	½ - 2 NPT and 2" (50mm)	1 (0.5)
400643	Kit used when main valve has a spring or air pressure pilot or in combination with temperature or solenoid pilots	2½ - 6 (65 - 150mm)	2 (1.0)

Pressure and/or Temperature Pilot Operated Steam Regulators (continued)

Series SPS Spring Pressure Control Pilots

Regulators

The Series SPS Spring pilot valves are designed for applications such as steam to hydronic converters, domestic hot water, manufacturing process, or others that

require constant outlet pressure. The Series SPS can also be used in conjunction with a series STPA Temperature pilot as a pressure limiter.

- Tight shut-off provided by hardened stainless steel disc and seat
- Packless construction eliminates seals that wear out and leak
- Travel stop and cover on diaphragm helps prevent over pressurization damage
- Removable strainer helps prevent debris from entering pilot
- Maximum temperature 450°F (232°C)
- Maximum inlet operating pressure 250 psig (17.3 bar)
- Outlet Pressure:
 - Minimum 2 psig (0.1 bar)
 - Maximum 175 psig (11.9 bar)
- Normal accuracy ±1 psig (0.07 bar)

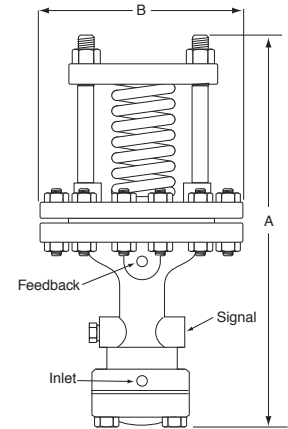

Materials of Construction	
Part	Specifications
Body	Cast Iron ASTM A126
Stem	Stainless Steel ASTM A582
Seat Ring	Stainless Steel ASTM A582
Diaphragm Screw	Steel ASTM A108
Pusher Plate	Steel ASTM A108
Adjusting Spring	Steel ASTM A229
Strainer	Stainless Steel ASTM A167
Diaphragm	Stainless Steel ASTM A666
Gaskets	Grafoil
Disc	Stainless Steel ASTM A276

Dimensions in. (mm)

Model	A	B
SPS-30	8¾ (222)	4⅝ (117)
SPS-60	8¾ (222)	4⅝ (117)
SPS-175	8¾ (222)	4⅝ (117)

Ordering Information
Spring Pilots

Model Number	Part Number	Outlet Pressure Range psig (bar)	Maximum Pressure psig (bar)	Weight (Approx.) lbs. (kg)	Spring Color
SPS-30	400277	2 - 30 (0.1-2.0)	250 (17.3)	7 (3.2)	Blue
SPS-60	400278	5 - 60 (0.3-4.1)	250 (17.3)	7 (3.2)	Red
SPS-175	400280	20 - 175 (1.4-11.9)	250 (17.3)	7 (3.2)	Gold

Note: When Spring pilots are used with Safety Relief valves, the Safety Relief valve must be at least 5 psi (.35 bar) higher than the desired steam operating pressure.

Series AP Air Pressure Control Pilots

The Series AP Air Pressure pilot valves are designed for applications such as injection molding, lab equipment, or others that require frequent outlet pressure changes. The **required Air PRV Regulator** allows remote adjustment of the outlet steam pressure.

- Lightweight, compact size prevents strain on mounting pipes
- Tight shut-off provided by hardened stainless steel pin and seat
- Packless construction eliminates seals that wear out and leak
- Travel stop and cover on diaphragm helps prevent over pressurization damage
- Removable strainer helps prevent debris from entering pilot
- No bias relay required
- Compatible with Pneumatic Temperature Pilots
- Maximum temperature 450°F (232°C)
- Maximum operating pressure 250 psig (17.3 bar)



Model AP-1A

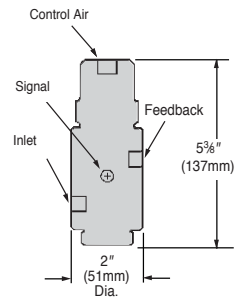

Model AP-4A

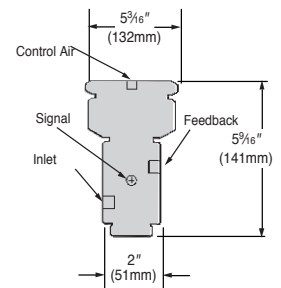

Materials of Construction	
Part	Specifications
Body	Steel ASTM A108
Pin	Stainless Steel ASTM A581
Seat	Stainless Steel ASTM A582
Diaphragm Button	Stainless Steel ASTM A582
Spring	Stainless Steel ASTM A313
Strainer	Stainless Steel ASTM A240
Diaphragm	Beryllium Copper ASTM B194
Upper Diaphragm	Stainless Steel ASTM A240
Gaskets	Copper ASTM B152

Ordering Information

Air Pilots

Model Number	Part Number	Pressure Ratio	Maximum Pressure lbs. (bar)	Weight (Approx.) lbs. (kg)
AP-1A	400556	1 : 1	250 (17.3)	4 (1.8)
AP-4A	400557	4 : 1	250 (17.3)	5 (2.3)

Air Loading Data

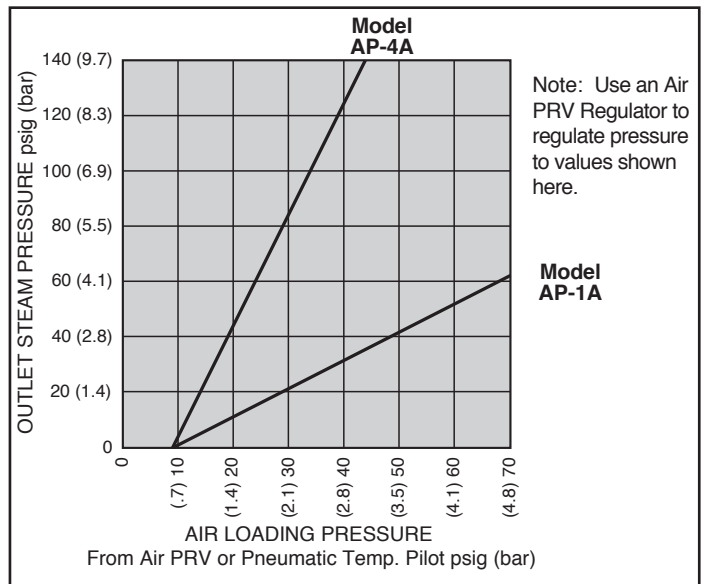

Air PRV Regulators

The Model Air PRV is designed to regulate air pressure directly to Air Pressure Control Pilots.

Ordering Information

Air PRV Regulators

Model Number	Part Number	Weight (Approx.) lbs. (kg)
Air PRV (Regulator w/gauge)	402722	1 (.5)



Air PRV Regulator

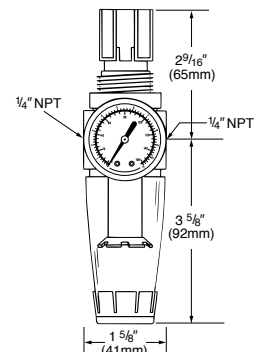

Pressure and/or Temperature Pilot Operated Steam Regulators (continued) Series STPA Self-Contained Temperature Control Pilots

The Series STPA Self-Contained Temperature pilot valves are designed for applications such as steam to water converters, domestic hot water, manufacturing process, or

others that require accurate temperature control of heated fluids.

Regulators

- Lightweight, compact size prevents strain on mounting pipes
- Easy temperature adjustment with calibrated dial
- Fast, easy installation
- Non-metallic, lockable temperature adjustment knob
- Tight shut-off provided by hardened stainless steel plug and seat
- Packless construction eliminates seals that wear out and leak
- Removable strainer helps prevent debris from entering pilot
- Bulb overheating protection up to 100°F (55.6°C)
- Durable 1/2" (15mm) NPT copper bulb with standard 10 ft. (3m) armored capillary (other lengths available)
- Optional Wells:
 - Copper
 - Stainless Steel
- Accuracy of control ± 10°F (± 5.6°C) with system recirculation
- Maximum temperature 450°F (232°C)
- Maximum operating pressure 250 psig (17.3 bar)

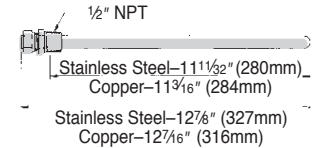
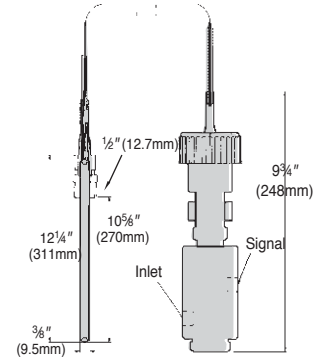

Well for Series STPA

Materials of Construction	
Part	Specifications
Body	Steel ASTM A108
Plug	Stainless Steel ASTM A582
Seat	Stainless Steel ASTM A582
Brass Components	CDA 360 ASTM B16
Tubing	Copper ASTM B75
Springs	Stainless Steel ASTM A313
Strainer	Stainless Steel ASTM A240
Gasket	Copper ASTM B152

Ordering Information Wells

Model	Part Number	Weight (Approx.) lbs. (kg)
Well, Copper	405529	1 (.5)
Well, SS	405532	3 (1.4)

Note: These wells are only for use with Self-Contained Temperature Pilots.

Ordering Information

Self-Contained Temperature Pilots (Optional wells must be ordered separately)

Model Number	Part Number	Temperature Range °F (°C)	Capillary Length ft. (m)	Maximum Pressure psig (bar)	Weight lbs. (kg)
STPA-200	400866	50–200 (10–93)	10 (3)	250 (17.3)	6 (2.7)
STPA-200	400868	50–200 (10–93)	15 (4.6)	250 (17.3)	6 (2.7)
STPA-200	400869	50–200 (10–93)	20 (6.1)	250 (17.3)	6 (2.7)
STPA-200	400874	50–200 (10–93)	25 (7.6)	250 (17.3)	6 (2.7)
STPA-200	400875	50–200 (10–93)	30 (9.1)	250 (17.3)	6 (2.7)
STPA-300	400880	150–300 (66–149)	10 (3)	250 (17.3)	6 (2.7)
STPA-300	400881	150–300 (66–149)	15 (4.6)	250 (17.3)	6 (2.7)
STPA-300	400884	150–300 (66–149)	20 (6.1)	250 (17.3)	6 (2.7)
STPA-300	400889	150–300 (66–149)	25 (7.6)	250 (17.3)	6 (2.7)
STPA-300	400890	150–300 (66–149)	30 (9.1)	250 (17.3)	6 (2.7)
STPA-400	400892	250–400 (121–204)	10 (3)	250 (17.3)	6 (2.7)

Ordering Information
Actuator Assemblies (includes actuator, knob and set screw)

Model Number	Part Number	Temperature Range		Capillary Length		Weight	
				°F	(°C)		
STPA-200	400844	50–200	(10–93)	10 (3)	3 (1.4)	3 (1.4)	
STPA-200	400845	50–200	(10–93)	15 (4.6)	3 (1.4)	3 (1.4)	
STPA-200	400847	50–200	(10–93)	20 (6.1)	3 (1.4)	3 (1.4)	
STPA-200	400848	50–200	(10–93)	25 (7.6)	3 (1.4)	3 (1.4)	
STPA-200	400850	50–200	(10–93)	30 (9.1)	3 (1.4)	3 (1.4)	
STPA-300	400851	150–300	(66–149)	10 (3)	3 (1.4)	3 (1.4)	
STPA-300	400853	150–300	(66–149)	15 (4.6)	3 (1.4)	3 (1.4)	
STPA-300	400854	150–300	(66–149)	20 (6.1)	3 (1.4)	3 (1.4)	
STPA-300	400856	150–300	(66–149)	25 (7.6)	3 (1.4)	3 (1.4)	
STPA-300	400857	150–300	(66–149)	30 (9.1)	3 (1.4)	3 (1.4)	
STPA-400	400859	250–400	(121–204)	10 (3)	3 (1.4)	3 (1.4)	

Pneumatic Temperature Control Pilots

Series 315 PNT For Shop Quality Air

The Series 315 PNT Pneumatic Temperature pilots are designed for applications such as refineries and factories, or others where rapidly changing load requirements occur. Pneumatic temperature pilots provide greater accuracy than self-contained temperature pilots. **An Air Pressure Pilot, an Air PRV Regulator and a Series 2000 Main Valve Steam Regulator *must* be used with the Model 315 PNT.**

- Lightweight, compact size prevents strain on mounting pipes
- Can be remotely located from the Main Valve and Air Pressure Pilot
- Bi-metallic temperature sensing
- Bulb options:
 - Brass
 - PTFE coated brass
 - Stainless Steel
- Direct or reverse acting modes of operation
- Optional wells (for brass bulb models only) allow bulb removal without draining system
- Air Consumption 0.50 scfm (.014m³)
- Supply Air Pressure
 - Nominal 18 psig (1.2 bar)
 - Minimum 12 psig (0.8 bar)
 - Maximum 36 psig (2.4 bar)
- Signal pressure at set-point temperature
 - 50% of supply pressure
 - 9 psig (0.6 bar) at nominal supply pressure
 - 6 psig (0.4 bar) at minimum supply pressure
 - 18 psig (1.2 bar) at maximum supply pressure
- Temperature Control Range
 - 50-300°F (10-149°C)
 - 200-450°F (93-232°C)
- Accuracy of control ± 4°F (± 2.2°C) with system recirculation

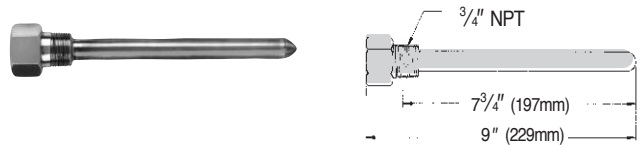
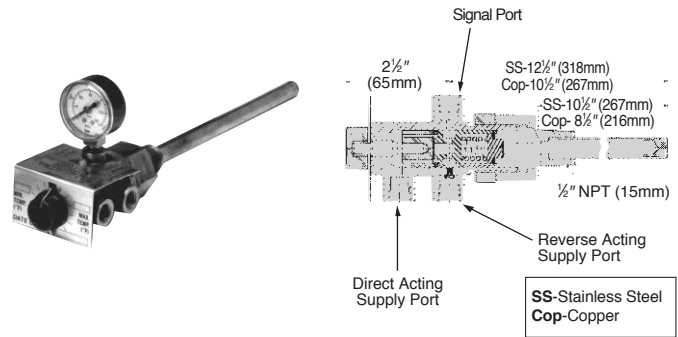

Well for Series 315 PNT

Ordering Information

Pneumatic Temperature Pilot

Model Number	Part Number	Temperature Range °F (°C)	Weight (Approx.) lbs. (kg)
315 Brass	402967	50-300 (10-149)	3 (1.4)
315 PTFE coated Brass	402970	50-300 (10-149)	3 (1.4)
315 Stainless Steel	402973	50-300 (10-149)	3 (1.4)
315 Stainless Steel	400461	200-450 (90-232)	3 (1.4)

Wells (Only for use with Model 315 with a brass bulb)

Model Number	Part Number	Weight (Approx.) lbs. (kg)
Well, Brass	400400	2 (.9)
Well, PTFE coated Brass	400463	2 (.9)
Well, Stainless Steel	403803	2 (.9)

Refer to Ordering Information on:
 – Air Pressure Control Pilots
 – Air PRV Regulators

Series 240 PNT For Control Quality Air

The Model 240 PNT Pneumatic Temperature pilots are designed for applications such as offices, schools, hospitals, or others where the unit will operate with a pneumatic temperature control system. The Model 240 PNT is specifically designed for the low air consumption required in such systems. They are also recommended for environments requiring rapidly changing loads or close temperature control. **An Air Pressure Pilot, an Air PRV Regulator and a Series 2000 Main Valve Steam Regulator *must* be used with the Model 240 PNT.**

- Low air consumption of 0.008 scfm (.00022m³)
- Calibrated temperature dial allows easy adjustment
- Copper sensing element
- Copper well (included) allows bulb removal without draining system
- Capillary length 6 ft. (1.8m)
- Supply Air Pressure
 - Nominal 20 psig (1.4 bar)
 - Minimum 15 psig (1.0 bar)
 - Maximum 30 psig (2.1 bar)
- Signal Range
 - 0.5 psig (.035 bar) minimum outlet pressure to within 0.5 psig (.035 bar) of supply pressure
- Temperature Control Range
 - 20° to 240°F (-7 to 116°C)
- Ambient Temperature Range
 - 40° to 150°F (4 to 66°C)
- Accuracy of control ± 4°F (± 2.2°C) with system recirculation

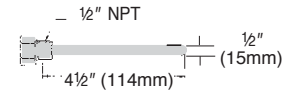
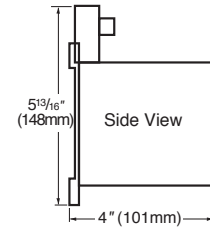
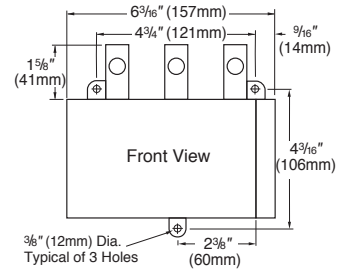

Regulators

Ordering Information

Pneumatic Temperature Pilots

Model Number	Part Number	Weight (Approx.) lbs. (kg)
240 PNT	400931	3 (1.4)

Refer to Ordering Information on:

- Air Pressure Control Pilots
- Air PRV Regulators

Electronic Temperature Control Pilots

Series GT610-IP Electro-Pneumatic Transducer

The Series GT610-IP Electro-Pneumatic transducer is designed for temperature control applications with a 35 psig (2.4 bar) clean filtered air supply and where a 4 to 20 mA DC or 0 to 10 VDC signal is provided by an electronic sensor. **An Air Pressure Pilot, an Air PRV Regulator and a Series 2000 Main Valve Steam Regulator *must* be used with the Series GT610-IP Relay.**

- 6-30 psig (.42 - 2.1 bar) modulated air output
- Optional gauge ports available to monitor output signal
- Supply pressure:
 - Minimum 15 psig (1.0 bar)
 - Maximum 36 psig (2.5 bar)
- Maximum steam output pressure from main valve:
 - 21 psig (1.5 bar) model AP-1 air pressure pilot
 - 84 psig (5.8 bar) model AP-4 air pressure pilot

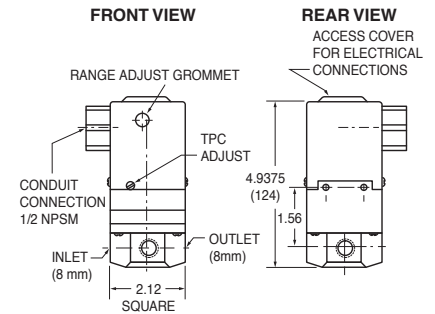

Ordering Information

Model Number	Part Number	Input Signal	Maximum Air Pressure psig (bar)	Weight lbs. (kg)
GT6108	401252	4 - 20 mA	36 (2.5)	2.5 (1.2)
GT6102	401253	0 - 10 VDC	36 (2.5)	2.5 (1.2)

Refer to Ordering Information on:

- Air Pressure Control Pilots
- Air PRV Regulators

Typical Installation

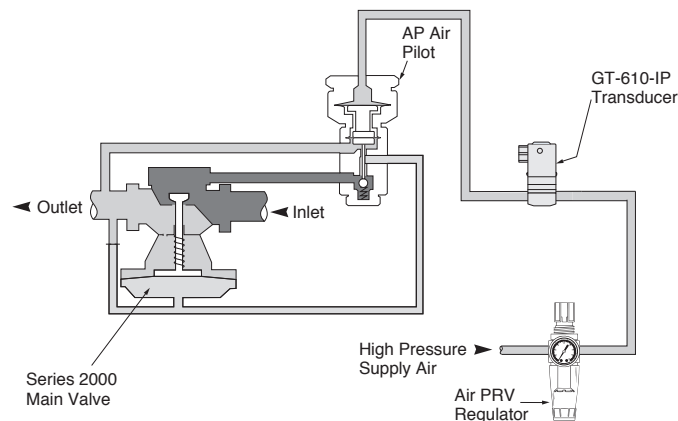

Series SLD Solenoid Pilots

Solenoid pilots are used with other pilots for overrides in domestic hot water or safety applications. The “Normally Closed” Solenoid pilots are designed to shut down the Main valve if there is a power failure. “Normally Open”

Solenoid pilots are designed for heating, or other applications where overheating will not be harmful, since they remain open during a power failure.

- Remote control
- Emergency shut-down feature
- Automatic start-up and shut-down capability (timer required)
- More economical to use than electric shut-off valves
- Operating modes
 - Normally Open
 - Normally Closed
- 120 volt electrical service required
- Maximum operating pressure 250 psig (17.3 bar)



Solenoid Pilot
Model SLD-100

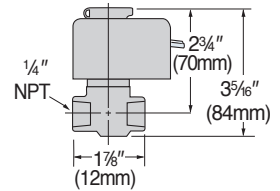

⚠ WARNING	
	<p>Do not use “Normally Open” Solenoid pilots for direct temperature control in domestic water applications. Failure to follow this warning can cause serious burns, personal injury, or death.</p>



Solenoid Pilot
Model SLD-250

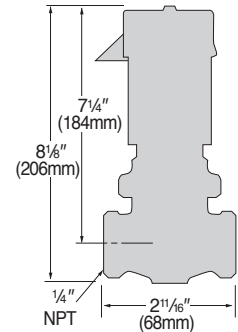

Ordering Information

Model Number	Part Number	Operating Mode	Inlet Pressure Operating Range psig (bar)		Weight (Approx.) lbs. (kg)
SLD-100	402247	Normally Open	0-100	(0-6.9)	1 1/2 (.68)
SLD-250	402259	Normally Open	0-250	(0-17.3)	6 (2.7)
SLD-100	402255	Normally Closed	0-100	(0-6.9)	1 1/2 (.68)
SLD-250	402258	Normally Closed	0-250	(0-17.3)	6 (2.7)

Self-Contained Pressure Reducing Valves

Series 754

The Series 754 is designed for applications such as commercial kitchens, labs, dry cleaners, or others that require system pressure reduction of steam in small equipment.

- For steam service
- For controlling steam pressure, where an accurate tight closing valve is required, on applications such as:
 - Small sterilizers
 - Cooking kettles or tables
 - Hand irons
 - Heating coils
 - Coffee urns
 - Unit heaters and pressing machines
- Adjustable outlet pressure
- Single seated for dead-end or continuous service
- Sizes 1/2" - 1" NPT
- Maximum pressure drop 100 psi (6.9 bar) – for more than 100 psi (6.9 bar) use multiple valves in series
- Minimum reduced pressure 1 psig (.069 bar)
- Maximum non-shock pressure 250 psig (17.3 bar) at 400°F (204°C)
- Maximum temperature 400°F (204°C)

How to Size Series 754 Valves

1. Determine the available initial steam inlet pressure.
2. Determine the reduced outlet pressure required based on your equipment.
3. Determine the capacity required.
4. Apply the specifications (as determined in steps (1-3) to the basic steam capacity table on the following page, and the information below.

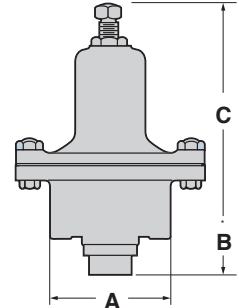

Dimensions in. (mm)

NPT Size in.	A	B	Weight (Approx.) lbs. (kg)
1/2	3 1/4 (82)	6 1/2 (165)	8 (3.6)
3/4	3 1/4 (82)	6 1/2 (165)	8 (3.6)
1	4 1/2 (114)	8 1/2 (216)	18 (8.2)

Materials of Construction

Part	Specifications
Body	Cast Iron
Seat	Stainless Steel
Diaphragm	Phosphor Bronze
Disc	Stainless Steel
Spring	Steel-Cadmium Plated
Connections	Screwed NPT

Ordering Information

Model Number	Part Number	NPT Size In.	Outlet Pressure Range psig (bar)
754	403050	1/2	0 - 10 (0 - 0.69)
754	403051	1/2	10 - 50 (0.69 - 3.5)
754	403052	1/2	40 - 100 (2.8 - 6.9)
754	403053	3/4	0 - 10 (0 - 0.69)
754	403054	3/4	10 - 50 (0.69 - 3.5)
754	403055	3/4	40 - 100 (2.8 - 6.9)
754	403056	1	0 - 10 (0 - 0.69)
754	403057	1	10 - 30 (0.69 - 2.1)
754	403058	1	30 - 50 (2.0 - 3.5)
754	403059	1	40 - 85 (2.8 - 5.8)

Series 754 (continued)
Capacities
Basic Steam Table - Pounds Per Hour (kg/hr.)

1/2 & 3/4 Inch Valves											
Outlet Pressure psig (bar)	Inlet Pressure psig (bar)										
	10 (.7)	20 (1.4)	30 (2.1)	40 (2.8)	50 (3.5)	70 (4.8)	100 (6.9)	125 (8.6)	150 (10.3)	200 (13.8)	250 (17.3)
2 (.14)	46 (21)	65 (30)	83 (38)	102 (46)	121 (55)	158 (72)	214 (97)	261 (119)	307 (140)	401 (182)	494 (225)
5 (.35)	38 (17)	65 (30)	83 (38)	102 (46)	121 (55)	158 (72)	214 (97)	261 (119)	307 (140)	401 (182)	494 (225)
10 (.7)		61 (28)	83 (38)	102 (46)	121 (55)	158 (72)	214 (97)	261 (119)	307 (140)	401 (182)	494 (225)
15 (1.0)		45 (20)	83 (38)	102 (46)	121 (55)	158 (72)	214 (97)	261 (119)	307 (140)	401 (182)	494 (225)
20 (1.4)			71 (32)	102 (46)	112 (51)	158 (72)	214 (97)	261 (119)	307 (140)	401 (182)	494 (225)
25 (1.7)				81 (37)	108 (49)	158 (72)	214 (97)	261 (119)	307 (140)	401 (182)	494 (225)
30 (2.1)				79 (36)	68 (31)	158 (72)	214 (97)	261 (119)	307 (140)	401 (182)	494 (225)
40 (2.8)					87 (40)	108 (49)	214 (97)	261 (119)	307 (140)	401 (182)	494 (225)
50 (3.5)						138 (63)	214 (97)	261 (119)	307 (140)	401 (182)	494 (225)
60 (4.1)							188 (86)	261 (119)	307 (140)	401 (182)	494 (225)
70 (4.8)							195 (89)	261 (119)	307 (140)	401 (182)	494 (225)
100 (6.9)								201 (91)	298 (136)	401 (182)	494 (225)

1 Inch Valves											
Outlet Pressure psig (bar)	Inlet Pressure psig (bar)										
	10 (.7)	20 (1.4)	30 (2.1)	40 (2.8)	50 (3.5)	70 (4.8)	100 (6.9)	125 (8.6)	150 (10.3)	200 (13.8)	250 (17.3)
2 (.14)	130 (59)	184 (84)	236 (107)	289 (131)	342 (156)	448 (204)	607 (276)	739 (336)	871 (396)	1135 (516)	1400 (637)
5 (.35)	106 (48)	184 (84)	236 (107)	289 (131)	342 (156)	448 (204)	607 (276)	739 (336)	871 (396)	1135 (516)	1400 (637)
10 (.7)		184 (84)	236 (107)	289 (131)	342 (156)	448 (204)	607 (276)	739 (336)	871 (396)	1135 (516)	1400 (637)
15 (1.0)		128 (58)	236 (107)	289 (131)	342 (156)	448 (204)	607 (276)	739 (336)	871 (396)	1135 (516)	1400 (637)
20 (1.4)			201 (91)	289 (131)	342 (156)	448 (204)	607 (276)	739 (336)	871 (396)	1135 (516)	1400 (637)
25 (1.7)				225 (102)	342 (156)	448 (204)	607 (276)	739 (336)	871 (396)	1135 (516)	1400 (637)
30 (2.1)					284 (129)	448 (204)	607 (276)	739 (336)	871 (396)	1135 (516)	1400 (637)
40 (2.8)					247 (112)	394 (179)	607 (276)	739 (336)	871 (396)	1135 (516)	1400 (637)
50 (3.5)						390 (177)	607 (276)	739 (336)	871 (396)	1135 (516)	1400 (637)
60 (4.1)							528 (240)	739 (336)	871 (396)	1135 (516)	1400 (637)
70 (4.8)							470 (214)	739 (336)	858 (390)	1135 (516)	1400 (637)
100 (6.9)								569 (259)	844 (384)	1135 (516)	1400 (637)

Thermostatic Temperature Regulators Series 1140 & 1141

The Series 1140 & 1141 Temperature Regulators are designed to maintain a desired temperature for commercial and institutional heating and cooling applications. They are self-actuated and vapor pressure operated.

- Operating modes
 - Direct Acting
 - Reverse Acting
 - Three Way
- Available in sizes 1/2" - 2" NPT
2 1/2" - 4" (65 - 100mm) Flanged
- Available in various body styles with different seating arrangements
- Hermetically sealed actuator available in temperature control ranges of 40°F (4.4°C) through 220°F (104°C) in increments of 40°F (22.2°C)
- Optional wells available in copper or stainless steel
- Heavy duty 10 ft. (3mm) capillary with flexible armor and reinforced ends
- Maximum body pressure
 - 1/2" - 1 1/2" NPT 250 psig (17.3 bar)
 - 2" NPT 200 psig (13.8 bar)
 - 2 1/2" - 4" (65-100mm) Flanged 125 psig (8.6 bar)
- Maximum body temperature 406°F (208°C)

Series 1140 Regulators are cross ambient filled and may be used where ambient temperature exceeds the set control temperature. Series 1141 Regulators are *not* cross ambient filled and should not be used where ambient temperature exceeds the set control temperature.

How to Select

Standard Unit Orders

1. Units must be ordered as Body Bracket Assemblies with separate Actuators. This offers a large variety of applications while maintaining low stock.
2. Determine body style based on type of service. See Selection Data Chart below.
3. Select an Actuator. Design temperature set point should be in the mid or upper portion of the range.

1140 TMP REG – Body Code – Body Size – Temperature Range

For example, to order a 1 inch NPT, 02 body style, 140° to 180°F (60-82°C) degree temperature range unit with standard bulb and capillary, your order should have the following:

Hoffman Specialty Part Number – 401307(Body Bracket Assemblies), and 400606 (Actuator – Cross ambient Filled)

Description – 1140 TMP REG 02 1.0 140 – 180

⚠ WARNING	
	<p>Series 1140 and 1141 Regulators fail open. An alarm or cut-off must be installed on applications where overheated water could cause harm. Failure to follow this warning could cause serious burns, personal injury, or death.</p>

⚠ CAUTION	
<p>Series 1140/1141 Temperature Regulators contain leaded brass and must not be used for potable water service.</p>	

Selection Data

Body Code	Service		Body Design	Recommended Application
	Water	Steam		
01	X	X	Two way Heating	Low pressure up to 50 psi (3.5 bar) Differential (Composition Disc)
02	X	X	Two way Heating	Low & High pressure up to 125 psi (8.6 bar) Differential (SS Seat and Disc)
02R	X		Two way Cooling	
03		X	Two way Heating	High pressure up to 250 psi (17.3 bar) Differential (SS Seat and Disc)
05	X	X	Two way Heating	High pressure up to 250 psi (17.3 bar) Differential (Double Seated SS)
05R	X		Two way Cooling	
06	X		Three way Mixing or Diverting	Sliding piston three way valve

Series 1140 & 1141 Regulators (continued)

Dimensions in. (mm)

Body Type	Size in. (mm)	A	B	C	D
Union ends	1/2 NPT	4 7/8 (124)	2 (51)	8 13/16 (224)	4 5/16 (110)
	3/4 NPT	5 3/8 (136)	2 3/16 (56)	9 (229)	4 5/16 (110)
	1 NPT	5 7/8 (149)	2 5/16 (59)	9 1/8 (232)	4 5/16 (110)
	1 1/4 NPT	6 7/8 (175)	2 5/8 (67)	9 7/16 (240)	4 5/16 (110)
	1 1/2 NPT	7 1/2 (190)	2 13/16 (72)	9 5/8 (245)	4 5/16 (110)
	2 NPT	8 1/2 (216)	3 13/16 (97)	10 (254)	4 5/16 (110)
Flanged 05 05R	2 1/2 (65)	7 5/8 (124)	4 9/16 (116)	16 5/8 (422)	6 3/8 (162)
	3 (80)	8 3/4 (222)	5 1/4 (133)	16 7/8 (428)	6 3/8 (162)
	4 (100)	10 1/4 (260)	5 7/8 (149)	17 3/8 (441)	6 3/8 (162)
Flanged 06	2 1/2 (65)	9 (229)	5 (127)	16 3/8 (416)	6 3/8 (162)
	3 (80)	9 1/2 (241)	5 1/4 (133)	16 3/4 (425)	6 3/8 (162)
	4 (100)	10 1/4 (260)	6 1/2 (165)	16 1/8 (410)	6 3/8 (162)

Copper Bulb Size, Dimensions in. (mm)

Valve Size in. (mm)	Actuator		E	F	G NPT
	1140	1141			
1/2 - 2 NPT	X		7/8 (22)	18 (457)	1
1/2 - 2 NPT		X	5/8 (16)	11 (280)	1
2 1/2 - 4 (65-100)	X		1 1/8 (29)	36 (914)	1 1/4

Wells, Dimensions in. (mm)

Series 1140

Regulator Bulb Size in. (mm)	A	B
7/8 x 18 (22 x 457)	18 1/2 (470)	1
1 1/8 x 36 (102 x 915)	36 1/2 (927)	1 1/4

Series 1141

5/8 x 11 (16 x 280)	11 1/2 (292)	1
---------------------	--------------	---

Wells

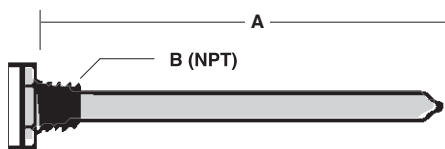

Series 1140 (Union end connection)
Direct and Reverse Acting Body Codes 01, 02, 02R, 03, 05, 05R, 06
1/2" - 2" NPT

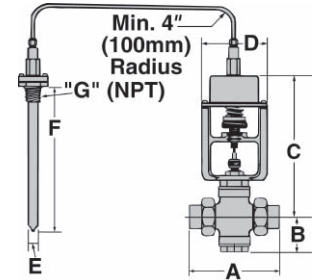

Union ends

Regulators



Series 1140 (Flanged end connection)
Direct and Reverse Acting
Body Codes 05, 05R,
2 1/2" - 4" (65-100mm)

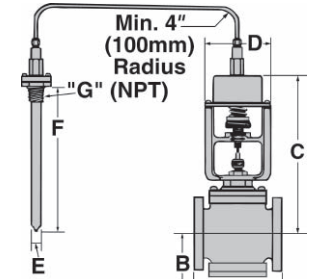

Flanged



Series 1140 (Flanged end connection)
Three Way Body Code 06
2 1/2" - 4" (65-100mm)

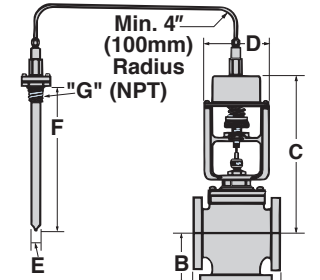

Flanged



Series 1141 (Union end connection)
Direct and Reverse Acting
Body Codes 01, 02, 02R, 03, 05 05R, 06
1/2" - 2" NPT

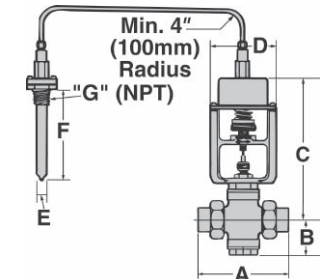

Union ends

Thermostatic Temperature Regulators (continued)
Series 1140 & 1141 (continued)

Regulators

Cv (Kv) Values

Body Code	Valve Size								
	NPT Valve Size, in.						Flanged Valve Size, in. (mm)		
	1/2 NPT	3/4 NPT	1 NPT	1 1/4 NPT	1 1/2 NPT	2 NPT	2 1/2 (65)	3 (88)	4 (100)
	Cv (Kv) Values								
01	2.7 (2.3)	5.7 (4.9)	11 (9.5)	16 (13.8)	20 (17.3)	25 (21.6)			
02 & 02R	2.7 (2.3)	5.7 (4.9)	11 (9.5)	16 (13.8)	20 (17.3)	25 (21.6)			
03		4.3 (3.7)	7.9 (6.8)	13 (11.3)	20 (17.3)	25 (21.6)			
05 & 05R		9.2 (8)	13 (11.3)	25 (21.6)	29 (25.1)	39 (33.7)	70 (60.6)	89 (77)	180 (155.7)
06	3.0 (2.6)	5.5 (4.8)	8.2 (7.1)	12.5 (10.8)	17.3 (15.0)	31.8 (27.5)	50 (43.2)	67 (58)	95 (82.2)

Thermostatic Temperature Regulators (continued)

Series 1140 & 1141 (continued)

Component Ordering Information

Body Bracket Assemblies

Part Number	Size in. (mm)	Body Code	Weight lbs. (kg)
401299	1/2 NPT	01	8 (3.6)
401300	3/4 NPT	01	10 (4.5)
401301	1 NPT	01	11 (5.0)
401302	1 1/4 NPT	01	12 (5.4)
401303	1 1/2 NPT	01	15 (6.8)
401304	2 NPT	01	21 (9.5)
401305	1/2 NPT	02	2 (.9)
401306	3/4 NPT	02	6 (2.7)
401307	1 NPT	02	6 (2.7)
401308	1 1/4 NPT	02	10 (4.5)
401309	1 1/2 NPT	02	10 (4.5)
401310	2 NPT	02	15 (6.8)
401312	1/2 NPT	02R	7 (3.2)
401311	3/4 NPT	02R	9 (4.1)
401313	1 NPT	02R	11 (5.0)
401314	1 1/4 NPT	02R	13 (5.9)
401317	1 1/2 NPT	02R	17 (7.7)
401320	2 NPT	02R	22 (10)
401321	3/4 NPT	03	10 (4.5)
401322	1 NPT	03	10 (4.5)
401323	1 1/4 NPT	03	12 (5.4)
401324	1 1/2 NPT	03	15 (6.8)
401325	2 NPT	03	18 (8.2)
401350	3/4 NPT	05	9 (4.1)
401353	1 NPT	05	9.3 (4.2)
401356	1 1/4 NPT	05	10 (4.5)
401359	1 1/2 NPT	05	14 (6.4)
401362	2 NPT	05	19 (8.6)
401365	2 1/2 (65)	05	64 (29)
401368	3 (80)	05	85 (39)
401371	4 (100)	05	115 (52)
401377	3/4 NPT	05R	9 (4.1)
401380	1 NPT	05R	11 (5.0)
401383	1 1/4 NPT	05R	12 (5.4)
401386	1 1/2 NPT	05R	15 (6.8)
401389	2 NPT	05R	21 (9.5)
401392	2 1/2 (65)	05R	74 (34)
401387	3 (80)	05R	80 (36)
401395	4 (100)	05R	115 (52)
401396	1/2 NPT	06	8 (3.6)
401397	3/4 NPT	06	9 (4.1)
401398	1 NPT	06	10 (4.5)
401399	1 1/4 NPT	06	12 (5.4)
401400	1 1/2 NPT	06	15 (6.8)
401401	2 NPT	06	21 (9.5)
401402	2 1/2 (65)	06	98 (44)
401403	3 (80)	06	98 (44)
401404	4 (100)	06	125 (57)

Series 1140 Actuators (Cross ambient filled)

Part Number	Temperature Range °F (°C)	Body Size		Body Code	Bulb Size (dia. x length)	Weight lbs. (kg)
		in. (mm)				
400558	40-80 (4.4-27)	1/2-2	NPT	All	7/8 x 18 (22 x 457)	7 (3.2)
400561	60-100 (16-38)	1/2-2	NPT	All	7/8 x 18 (22 x 457)	7 (3.2)
400562	80-120 (27-49)	1/2-2	NPT	All	7/8 x 18 (22 x 457)	7 (3.2)
400563	100-140 (38-60)	1/2-2	NPT	All	7/8 x 18 (22 x 457)	7 (3.2)
400567	120-160 (49-71)	1/2-2	NPT	All	7/8 x 18 (22 x 457)	7 (3.2)
400606	140-180 (60-82)	1/2-2	NPT	All	7/8 x 18 (22 x 457)	7 (3.2)
400607	160-200 (71-93)	1/2-2	NPT	All	7/8 x 18 (22 x 457)	7 (3.2)
400570	180-220 (82-104)	1/2-2	NPT	All	7/8 x 18 (22 x 457)	7 (3.2)
400428	40-80 (4.4-27)	2 1/2-4 (65-100)		05&06	1 1/8 x 36 (29 x 914)	20 (9.1)
400572	60-100 (16-38)	2 1/2-4 (65-100)		05&06	1 1/8 x 36 (29 x 914)	20 (9.1)
400573	80-120 (27-49)	2 1/2-4 (65-100)		05&06	1 1/8 x 36 (29 x 914)	20 (9.1)
400574	100-140 (38-60)	2 1/2-4 (65-100)		05&06	1 1/8 x 36 (29 x 914)	20 (9.1)
400575	120-160 (49-71)	2 1/2-4 (65-100)		05&06	1 1/8 x 36 (29 x 914)	20 (9.1)
400615	140-180 (60-82)	2 1/2-4 (65-100)		05&06	1 1/8 x 36 (29 x 914)	20 (9.1)
400616	160-200 (71-93)	2 1/2-4 (65-100)		05&06	1 1/8 x 36 (29 x 914)	20 (9.1)
400617	180-220 (82-104)	2 1/2-4 (65-100)		05&06	1 1/8 x 36 (29 x 914)	20 (9.1)

Series 1141 Actuators (Non-cross ambient filled)

Do not use where ambient temperature exceeds set temperature control.

Part Number	Temperature Range °F (°C)	Body Size In.	Body Code	Bulb Size (dia. X length)	Weight lbs (kg)
400980	120-160 (49-71)	1/2 -2 NPT	All	5/8 x 11 (16 x 280)	7 (32)
400981	140-180 (60-82)	1/2 -2 NPT	All	5/8 x 11 (16 x 280)	7 (32)
400982	160-200 (71-93)	1/2 -2 NPT	All	5/8 x 11 (16 x 280)	7 (32)
400983	180-220 (82-104)	1/2 -2 NPT	All	5/8 x 11 (16 x 280)	7 (32)

Note: All models have copper bulb and 10 ft. (3m) capillary.

Wells (Refer to the Actuator Ordering Information chart [above] to determine proper bulb size)

Part Number	Series	Material	Bulb Size (Dia. x Length)	
			in. (mm)	Weight lbs. (kg)
400445	1141	Copper	5/8 x 11 (16 x 280)	2 (.9)
401179	1140	Copper	7/8 x 18 (22 x 457)	2 (.9)
401181	1140	Copper	1 1/8 x 36 (29 x 914)	4 (1.8)
401180	1140	SS	7/8 x 18 (22 x 457)	3 (1.4)
405526	1140	SS	1 1/8 x 36 (29 x 914)	4 (1.8)

Thermostatic Temperature Regulators (continued) Series 1140 & 1141

Direct Acting

The Series 1140 and 1141 Direct Acting Regulators are designed for commercial and institutional heating systems and equipment applications such as hot water tanks, vats,

steam tables, sterilizing equipment, instantaneous heaters, apartment buildings, or others that require steam temperature control.

Body Code 01

- Steam or Water Service—
for Positive dead end service
- Single Seat, Composition Disc, Brass Trim—
Brass integral seat
- Body—Brass body, union ends
- Maximum Differential Pressure:
 - ½" NPT — 50 psi (3.5 bar)
 - ¾" NPT — 50 psi (3.5 bar)
 - 1" NPT — 32 psi (2.2 bar)
 - 1¼" NPT — 20 psi (1.4 bar)
 - 1½" NPT — 16 psi (1.1 bar)
 - 2" NPT — 8 psi (.55 bar)

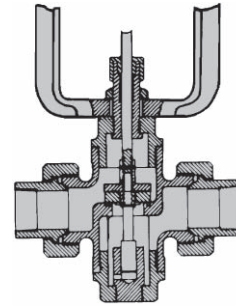

Ordering Information - (For Assembled Body Bracket and Actuators) Series 1140 Regulators (Cross ambient filled)

Size in.	Temperature Range								Weight (Approx.) lbs. (kg)
	40–80°F (4.4–27°C)	60–100°F (16–38°C)	80–120°F (27–49°C)	100–140°F (38–60°C)	120–160°F (49–71°C)	140–180°F (60–82°C)	160–200°F (71–93°C)	180–220°F (82–104°C)	
Part Number									
½ NPT	400558 + 401299	400561 + 401299	400562 + 401299	400563 + 401299	400567 + 401299	400606 + 401299	400607+ 401299	400570 + 401299	14 (6.4)
¾ NPT	400558 + 401300	400561 + 401300	400562 + 401300	401563 + 401300	400567 + 401300	400606 + 401300	400607+ 401300	400570 + 401300	15 (6.8)
1 NPT	400558 + 401301	400561 + 401301	400562 + 401301	400563 + 401301	400567 + 401301	400606 + 401301	400607+ 401301	400570 + 401301	18 (8.2)
1¼ NPT	400558+ 401302	400561 + 401302	400562 + 401302	400563 + 401302	400567 + 401302	400606 + 401302	400607+ 401302	400570 + 401302	19 (8.6)
1½ NPT	400558+ 401303	400561 + 401303	400562 + 401303	400563 + 401303	400567 + 401303	400606 + 401303	400607+ 401303	400570 + 401303	22 (10.0)
2 NPT	400558+ 401304	400561 + 401304	400562 + 401304	400563 + 401304	400567 + 401304	400606 + 401304	400607+ 401304	400570 + 401304	28 (12.7)

Series 1140 & 1141 (continued)

Series 1141 Regulators (Non-cross ambient filled)

Do not use where ambient temperature exceeds set temperature control.

NPT Size in.	Temperature Range				Weight (Approx.) lbs. (kg)
	120–160°F (49–71°C)	140–180°F (60–82°C)	160–200°F (71–93°C)	180–220°F (82–104°C)	
Part Number					
½ NPT	400980 + 401299	400981 + 401299	400982 + 401299	400983 + 401299	14 (6.4)
¾ NPT	400980 + 401300	400981 + 401300	400982 + 401300	400983 + 401300	15 (6.8)
1 NPT	400980 + 401301	400981 + 401301	400982 + 401301	400983 + 401301	18 (8.1)
1¼ NPT	400980 + 401302	400981 + 401302	400982 + 401302	400983 + 401302	19 (8.6)
1½ NPT	400980 + 401303	400981 + 401303	400982 + 401303	400983 + 401303	22 (10.0)
2 NPT	400980 + 401304	400981 + 401304	400982 + 401304	400983 + 401304	28 (12.7)

Series 1140 & 1141 Wells

Part Number	Series	Material	Bulb Size (dia x length in (mm))	Weight lbs. (kg)
400445	1141	Copper	5/8 x 11 (16 X 280)	2 (.9)
401179	1140	Copper	7/8 x 18 (22 X 457)	2 (.9)
401180	1140	316 SS	7/8 x 18 (22 X 457)	3 (1.4)

Capacities – Steam Flow, lbs./hr. (kg/hr.) vs Pressure Drop psi (bar)

Body Code 01 Direct Acting, Single Seated Valves

Size in.			½ NPT	¾ NPT	1 NPT	1¼ NPT	1½ NPT	2 NPT
Pressure psi (bar)			Steam Flow lbs./hr. (kg/hr.)					
Inlet	Outlet	Drop						
3 (.2)	2 (.14)	1 (.07)	33 (14)	70 (31)	134 (60)	195 (88)	244 (110)	305 (138)
	1 (.07)	2 (.14)	45 (20)	96 (43)	185 (83)	269 (122)	336 (152)	420 (190)
5 (.35)	3 (.21)	2 (.14)	48 (21)	101 (45)	196 (88)	285 (129)	356 (161)	445 (202)
	2 (.14)	3 (.21)	57 (25)	121 (54)	233 (105)	339 (153)	424 (192)	530 (240)
10 (.7)	8 (.56)	2 (.14)	54 (24)	115 (52)	222 (100)	323 (146)	404 (183)	505 (229)
	6 (.42)	4 (.28)	74 (33)	156 (70)	300 (136)	437 (198)	546 (247)	683 (310)
	4 (.28)	6 (.42)	86 (39)	181 (82)	350 (158)	509 (231)	636 (288)	795 (360)
15 (1.0)	12 (.83)	3 (.21)	72 (32)	153 (69)	295 (133)	429 (194)	536 (243)	
	9 (.62)	6 (.42)	97 (44)	204 (92)	394 (178)	572 (259)	716 (325)	
	6 (.42)	9 (.62)	110 (49)	233 (105)	450 (204)	654 (296)	818 (371)	
20 (1.4)	16 (1.1)	4 (.28)	90 (40)	190 (86)	365 (165)	531 (241)		
	12 (.83)	8 (.56)	118 (53)	250 (113)	482 (258)	701 (318)		
	8 (.56)	12 (.83)	134 (60)	282 (128)	545 (288)	792 (359)		
25 (1.7)	20 (1.4)	5 (.34)	107 (48)	225 (102)	435 (197)			
	15 (1.0)	10 (.69)	140 (63)	295 (133)	569 (258)			
	10 (.69)	15 (1.0)	156 (70)	329 (149)	635 (288)			
30 (2.1)	25 (1.7)	5 (.34)	114 (51)	241 (109)	465 (211)			
	20 (1.4)	10 (.69)	151 (68)	319 (144)	615 (279)			
	15 (1.0)	15 (1.0)	171 (77)	361 (163)	696 (315)			
40 (2.8)	35 (2.4)	5 (.34)	128 (58)	270 (122)				
	30 (2.1)	10 (.70)	171 (77)	361 (163)				
	20 (1.4)	20 (1.4)	213 (96)	450 (204)				
50 (3.5)	40 (2.8)	10 (.69)	190 (86)	400 (28)				
	30 (2.1)	20 (1.4)	242 (109)	511 (35)				
	20 (1.4)	30 (2.1)	261 (118)	552 (38)				

Thermostatic Temperature Regulators (continued)

Series 1140 & 1141 (continued)

Body Code 02

- Steam or Water Service—
Used for dead end shut-off where higher temperatures and pressures prevail
- Stainless Steel Single Seat and Trim—
1/2" — Removable stainless steel seat and cone disc
3/4" - 2" — Integral stainless steel seat ring and bottom guided seat disc
- Body—Brass body, union ends
- Maximum Differential Pressure:
1/2" NPT - 125 psi (8.6 bar) 1 1/4" NPT - 20 psi (1.4 bar)
3/4" NPT - 60 psi (4.1 bar) 1 1/2" NPT - 16 psi (1.1 bar)
1" NPT - 32 psi (2.2 bar) 2" NPT - 8 psi (.55 bar)

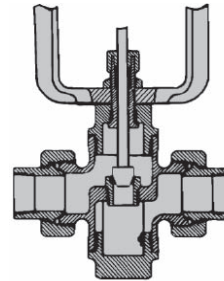

1/2" NPT

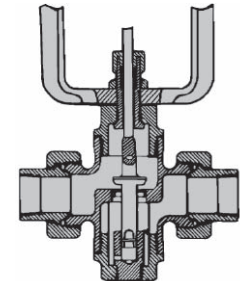

3/4" - 2" NPT

Ordering Information - (For Body Bracket and Actuators)

Series 1140 Regulators (Cross ambient filled)

Size in.	Temperature Range								Weight (Approx.) lbs. (kg)
	40–80°F (4.4–27°C)	60–100°F (16–38°C)	80–120°F (27–49°C)	100–140°F (38–60°C)	120–160°F (49–71°C)	140–180°F (60–82°C)	160–200°F (71–93°C)	180–220°F (82–104°C)	
	Part Number								
1/2 NPT	400558 + 401305	400561 + 401305	400562 + 401305	400563 + 401305	400567 + 401305	400606 + 401305	400607 + 401305	400570 + 401305	14 (6.4)
3/4 NPT	400558 + 401306	400561 + 401306	400562 + 401306	400563 + 401306	400567 + 401306	400606 + 401306	400607 + 401306	400570 + 401306	15 (6.8)
1 NPT	400558 + 401307	400561 + 401307	400562 + 401307	400563 + 401307	400567 + 401307	400606 + 401307	400607 + 401307	400570 + 401307	18 (8.2)
1 1/4 NPT	400558 + 401308	400561 + 401308	400562 + 401308	400563 + 401308	400567 + 401308	400606 + 401308	400607 + 401308	400570 + 401308	19 (8.6)
1 1/2 NPT	400558 + 401309	400561 + 401309	400562 + 401309	400563 + 401309	400567 + 401309	400606 + 401309	400607 + 401309	400570 + 401309	22 (10.0)
2 NPT	400558 + 401310	400561 + 401310	400562 + 401310	400563 + 401310	400567 + 401310	400606 + 401310	400607 + 401310	400570 + 401310	28 (12.7)

Series 1141 Regulators (Non-cross ambient filled)

Do not use where ambient temperature exceeds set temperature control.

Size in. (mm)	Temperature Range				Weight (Approx.) lbs. (kg)
	120–160°F (49–71°C)	140–180°F (60–82°C)	160–200°F (71–93°C)	180–220°F (82–104°C)	
	Part Number				
1/2 NPT	400980 + 401305	400981 + 401305	400982 + 401305	400983 + 401305	14 (6.4)
3/4 NPT	400980 + 401306	400981 + 401306	400982 + 401306	400983 + 401306	15 (6.8)
1 NPT	400980 + 401307	400981 + 401307	400982 + 401307	400983 + 401307	18 (8.2)
1 1/4 NPT	400980 + 401308	400981 + 401308	400982 + 401308	400983 + 401308	19 (8.6)
1 1/2 NPT	400980 + 401309	400981 + 401309	400982 + 401309	400983 + 401309	22 (10.0)
2 NPT	400980 + 401310	400981 + 401310	400982 + 401310	400983 + 401310	28 (12.7)

Series 1140 & 1141 (continued)
Series 1140 & 1141 Wells

Part Number	Series	Material	Bulb Size (dia x length in (mm))	Weight lbs. (kg)
400445	1141	Copper	5/8 x 11 (16 X 280)	2 (.9)
401179	1140	Copper	7/8 x 18 (22 X 457)	2 (.9)
401180	1140	316 SS	7/8 x 18 (22 X 457)	3 (1.4)

Capacities – Steam Flow, lbs./hr. (kg/hr.) vs Pressure Drop psi (bar)
Body Code 02 Direct Acting, Single Seated Valves

Size in.			1/2 NPT	3/4 NPT	1 NPT	1 1/4 NPT	1 1/2 NPT	2 NPT
Pressure psi (bar)			Steam Flow lbs./hr. (kg/hr.)					
Inlet	Outlet	Drop						
3 (.2)	2 (.14)	1 (.07)	33 (14)	70 (31)	134 (60)	195 (88)	244 (110)	305 (138)
	1 (.07)	2 (.14)	45 (20)	96 (43)	185 (83)	269 (122)	336 (152)	420 (190)
5 (.35)	3 (.21)	2 (.14)	48 (21)	101 (45)	196 (88)	285 (129)	356 (161)	445 (201)
	2 (.14)	3 (.21)	57 (25)	121 (54)	233 (105)	339 (153)	424 (192)	530 (240)
10 (.7)	8 (.56)	2 (.14)	54 (24)	115 (52)	222 (100)	323 (146)	404 (183)	505 (229)
	6 (.42)	4 (.28)	74 (33)	156 (70)	300 (136)	437 (198)	546 (247)	683 (309)
	4 (.28)	6 (.42)	86 (39)	181 (82)	350 (158)	509 (230)	636 (288)	795 (360)
15 (1.0)	12 (.83)	3 (.21)	72 (32)	153 (69)	295 (133)	429 (194)	536 (243)	
	9 (.62)	6 (.42)	97 (44)	204 (92)	394 (178)	572 (259)	716 (324)	
	6 (.42)	9 (.62)	110 (49)	233 (105)	450 (204)	654 (296)	818 (371)	
20 (1.4)	16 (1.1)	4 (.28)	90 (40)	190 (86)	365 (165)	531 (240)		
	12 (.83)	8 (.56)	118 (53)	250 (113)	482 (218)	701 (317)		
	8 (.56)	12 (.83)	134 (60)	282 (127)	545 (247)	792 (359)		
25 (1.7)	20 (1.4)	5 (.34)	107 (48)	225 (102)	435 (197)			
	15 (1.0)	10 (.69)	140 (63)	295 (133)	569 (258)			
	10 (.70)	15 (1.0)	156 (70)	329 (149)	635 (288)			
30 (2.1)	25 (1.7)	5 (.34)	114 (51)	241 (109)	465 (210)			
	20 (1.4)	10 (.69)	151 (68)	319 (144)	615 (278)			
	15 (1.0)	15 (1.0)	171 (77)	361 (163)	696 (315)			
40 (2.8)	35 (2.4)	5 (.34)	128 (58)	270 (122)				
	30 (2.1)	10 (.69)	171 (77)	361 (163)				
	20 (1.4)	20 (1.4)	213 (96)	450 (204)				
50 (3.5)	40 (2.8)	10 (.69)	190 (86)	400 (181)				
	30 (2.1)	20 (1.4)	242 (109)	511 (231)				
	20 (1.4)	30 (2.1)	261 (118)	552 (250)				
60 (4.1)	50 (3.5)	10 (.69)	206 (93)	435 (197)				
	40 (2.8)	20 (1.4)	268 (121)	565 (256)				
	30 (2.1)	30 (2.1)	297 (134)	627 (284)				
70 (4.8)	60 (4.2)	10 (.69)	221 (100)					
	50 (3.5)	20 (1.4)	292 (132)					
	40 (2.8)	30 (2.1)	329 (149)					
	30 (2.1)	40 (2.8)	343 (155)					
80 (5.5)	70 (4.9)	10 (.69)	236 (107)					
	60 (4.2)	20 (1.4)	313 (141)					
	50 (3.5)	30 (2.1)	356 (161)					
	40 (2.8)	40 (2.8)	378 (171)					
90 (6.2)	80 (5.6)	10 (.69)	249 (112)					
	70 (4.9)	20 (1.4)	332 (150)					
	60 (4.2)	30 (2.1)	383 (173)					
	30 (2.1)	40 (2.8)	413 (187)					
100 (6.9)	40 (2.8)	50 (3.5)	424 (192)					
	90 (6.3)	10 (.69)	262 (118)					
	80 (5.6)	20 (1.4)	354 (160)					
	70 (4.9)	30 (2.1)	408 (185)					
125 (8.6)	60 (4.2)	40 (2.8)	443 (200)					
	50 (3.5)	50 (3.5)	462 (209)					
	110 (7.6)	15 (1.0)	351 (159)					
	100 (6.9)	25 (1.7)	435 (197)					
	90 (6.3)	35 (2.4)	491 (222)					
	80 (5.6)	45 (3.1)	529 (239)					
	70 (4.9)	55 (3.8)	554 (251)					
	60 (4.2)	65 (4.4)	564 (255)					

Thermostatic Temperature Regulators (continued)

Series 1140 & 1141 (continued)

Body Code 03

- Steam Service Only—
Used for dead end service up to maximum body steam pressure
- Stainless Steel Balanced Single Seat and Trim—
Removable stainless steel seat, disc, and balancing piston
- Body— $\frac{3}{4}$ " through 2" NPT—brass body, union ends
- Maximum Differential Pressure:
 $\frac{3}{4}$ " NPT — 250 psi (17.3 bar)
 1" NPT — 200 psi (13.8 bar)
 1 $\frac{1}{4}$ " NPT — 200 psi (13.8 bar)
 1 $\frac{1}{2}$ " NPT — 200 psi (13.8 bar)
 2" NPT — 150 psi (10.3 bar)

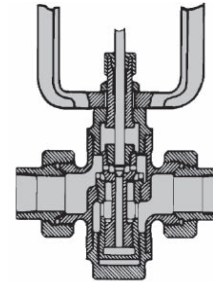

Regulators

Ordering Information - (For Body Bracket and Actuators)

Series 1140 Regulators (Cross ambient filled)

Size in.	Temperature Range								Weight (Approx.) lbs. (kg)
	40–80°F (4.4–27°C)	60–100°F (16–38°C)	80–120°F (27–49°C)	100–140°F (38–60°C)	120–160°F (49–71°C)	140–180°F (60–82°C)	160–200°F (71–93°C)	180–220°F (82–104°C)	
	Part Number								
$\frac{3}{4}$ NPT	400558 + 401321	400561 + 401321	400562 + 401321	400563 + 401321	400567 + 401321	400606 + 401321	400607 + 401321	400570 + 401321	15 (6.8)
1 NPT	400558 + 401322	400561 + 401322	400562 + 401322	400563 + 401322	400567 + 401322	400606 + 401322	400607 + 401322	400570 + 401322	18 (8.2)
1 $\frac{1}{4}$ NPT	400558 + 401323	400561 + 401323	400562 + 401323	400563 + 401323	400567 + 401323	400606 + 401323	400607 + 401323	400570 + 401323	19 (8.6)
1 $\frac{1}{2}$ NPT	400558 + 401324	400561 + 401324	400562 + 401324	400563 + 401324	400567 + 401324	400606 + 401324	400607 + 401324	400570 + 401324	22 (10.0)
2 NPT	400558 + 401325	400561 + 401325	400562 + 401325	400563 + 401325	400567 + 401325	400606 + 401325	400607 + 401325	400570 + 401325	28 (12.7)

Series 1141 Regulators (Non-cross ambient filled)

Do not use where ambient temperature exceeds set temperature control.

Size in.	Temperature Range				Weight (Approx.) lbs. (kg)
	120–160°F (49–71°C)	140–180°F (60–82°C)	160–200°F (71–93°C)	180–220°F (82–104°C)	
	Part Number				
$\frac{3}{4}$ NPT	400980 + 401321	400981 + 401321	400982 + 401321	400983 + 401321	15 (6.8)
1 NPT	400980 + 401322	400981 + 401322	400982 + 401322	400983 + 401322	18 (8.2)
1 $\frac{1}{4}$ NPT	400980 + 401323	400981 + 401323	400982 + 401323	400983 + 401323	19 (8.6)
1 $\frac{1}{2}$ NPT	400980 + 401324	400981 + 401324	400982 + 401324	400983 + 401324	22 (10.0)
2 NPT	400980 + 401325	400981 + 401325	400982 + 401325	400983 + 401325	28 (12.7)

Series 1140 & 1141 Wells

Part Number	Series	Material	Bulb Size (dia x length in (mm))	Weight lbs. (kg)
400445	1141	Copper	$\frac{5}{8}$ x 11 (16 X 280)	2 (.9)
401179	1140	Copper	$\frac{7}{8}$ x 18 (22 X 457)	2 (.9)
401180	1140	316 SS	$\frac{7}{8}$ x 18 (22 X 457)	3 (1.4)

Series 1140 & 1141 (continued)
Body Code 03 Direct Acting, Balanced Single Seated Valves (Steam Service Only)

Size in.			3/4 NPT	1 NPT	1 1/4 NPT	1 1/2 NPT	2 NPT
Pressure psi (bar)			Steam Flow lbs./hr. (kg/hr.)				
Inlet	Outlet	Drop					
3 (.2)	2 (.14)	1 (.07)	52 (23)	96 (43)	159 (72)	244 (110)	305 (138)
	1 (.07)	2 (.14)	72 (32)	133 (60)	218 (98)	336 (152)	420 (190)
5 (.35)	3 (.21)	2 (.14)	77 (34)	141 (63)	231 (104)	356 (161)	445 (201)
	2 (.14)	3 (.21)	91 (41)	167 (75)	276 (125)	424 (192)	530 (240)
10 (.7)	8 (.56)	2 (.14)	87 (39)	160 (72)	263 (119)	404 (183)	505 (229)
	6 (.42)	4 (.28)	117 (53)	216 (97)	355 (161)	546 (247)	683 (309)
	4 (.28)	6 (.42)	138 (62)	251 (113)	413 (187)	636 (288)	795 (360)
15 (1.0)	12 (.83)	3 (.21)	115 (52)	212 (96)	348 (157)	536 (243)	670 (303)
	9 (.62)	6 (.42)	154 (69)	283 (128)	465 (210)	716 (324)	895 (405)
	6 (.42)	9 (.62)	176 (79)	323 (146)	532 (241)	818 (371)	1020 (462)
20 (1.4)	16 (1.1)	4 (.28)	143 (64)	262 (118)	432 (195)	664 (301)	830 (376)
	12 (.83)	8 (.56)	188 (85)	346 (156)	569 (258)	876 (397)	1100 (498)
	8 (.56)	12 (.83)	213 (96)	391 (177)	644 (292)	990 (449)	1240 (562)
25 (1.7)	20 (1.4)	5 (.34)	170 (77)	312 (141)	514 (233)	790 (358)	988 (448)
	15 (1.0)	10 (.69)	222 (100)	408 (185)	672 (304)	1030 (467)	1290 (585)
	10 (.69)	15 (1.0)	248 (112)	456 (206)	750 (340)	1150 (521)	1440 (653)
30 (2.1)	25 (1.7)	5 (.34)	182 (82)	334 (151)	550 (249)	846 (383)	1060 (480)
	20 (1.4)	10 (.69)	240 (108)	442 (200)	727 (329)	1120 (508)	1400 (635)
	15 (1.0)	15 (1.0)	272 (123)	500 (226)	823 (373)	1270 (576)	1580 (716)
40 (2.8)	35 (2.4)	5 (.34)	203 (92)	374 (169)	615 (278)	946 (429)	1180 (535)
	30 (2.1)	10 (.69)	273 (123)	501 (227)	824 (373)	1270 (576)	1590 (721)
	20 (1.4)	20 (1.4)	340 (154)	624 (283)	1030 (467)	1580 (716)	1980 (898)
50 (3.5)	40 (2.8)	10 (.69)	302 (136)	555 (251)	913 (414)	1400 (635)	1760 (798)
	30 (2.1)	20 (1.4)	386 (175)	709 (321)	1170 (530)	1790 (811)	2240 (1016)
	20 (1.4)	30 (2.1)	416 (188)	765 (347)	1260 (571)	1940 (879)	2420 (1097)
60 (4.1)	50 (3.5)	10 (.69)	328 (148)	603 (273)	992 (449)	1530 (694)	1910 (866)
	40 (2.8)	20 (1.4)	427 (193)	784 (355)	1290 (585)	1980 (898)	2480 (1124)
	30 (2.1)	30 (2.1)	473 (214)	869 (394)	1430 (648)	2200 (997)	2750 (1247)
70 (4.8)	60 (4.2)	10 (.69)	353 (160)	648 (293)	1070 (485)	1640 (743)	2050 (929)
	50 (3.5)	20 (1.4)	464 (210)	853 (386)	1400 (635)	2160 (979)	2700 (1224)
	40 (2.8)	30 (2.1)	525 (238)	964 (437)	1590 (721)	2440 (1106)	3050 (1383)
	30 (2.1)	40 (2.8)	546 (247)	1000 (453)	1650 (748)	2540 (1152)	3180 (1442)
80 (5.5)	70 (4.9)	10 (.69)	375 (170)	690 (312)	1130 (512)	1750 (793)	2180 (988)
	60 (4.2)	20 (1.4)	499 (226)	916 (415)	1510 (684)	2320 (1052)	2900 (1315)
	50 (3.5)	30 (2.1)	568 (257)	1040 (471)	1720 (780)	2640 (1197)	3300 (1496)
	40 (2.8)	40 (2.8)	602 (273)	1110 (503)	1820 (825)	2800 (1270)	3500 (1587)
90 (6.2)	80 (5.6)	10 (.69)	397 (180)	729 (330)	1200 (544)	1850 (839)	2310 (1047)
	70 (4.9)	20 (1.4)	529 (239)	972 (440)	1600 (725)	2460 (1115)	3080 (1397)
	60 (4.2)	30 (2.1)	611 (277)	1120 (508)	1850 (839)	2840 (1288)	3550 (1610)
	50 (3.5)	40 (2.8)	658 (298)	1210 (548)	1990 (902)	3060 (1388)	3830 (1737)
100 (6.9)	40 (2.8)	50 (3.5)	675 (306)	1240 (562)	2040 (925)	3140 (1424)	3930 (1782)
	90 (6.3)	10 (.69)	418 (189)	767 (347)	1260 (571)	1940 (879)	2430 (1102)
	80 (5.6)	20 (1.4)	563 (255)	1030 (467)	1700 (771)	2620 (1188)	3280 (1487)
	70 (4.9)	30 (2.1)	649 (294)	1190 (539)	1960 (889)	3020 (1369)	3780 (1714)
125 (8.6)	60 (4.2)	40 (2.8)	705 (319)	1300 (589)	2130 (966)	3280 (1487)	4100 (1859)
	50 (3.5)	50 (3.5)	735 (333)	1350 (612)	2220 (1006)	3420 (1551)	4280 (1941)
	110 (7.6)	15 (1.0)	559 (253)	1030 (467)	1690 (766)	2600 (1179)	3250 (1474)
	100 (6.9)	25 (1.7)	692 (313)	1270 (576)	2090 (948)	3220 (1460)	4030 (1828)
	90 (6.3)	35 (2.4)	783 (355)	1440 (653)	2370 (1075)	3640 (1651)	4550 (2063)
	80 (5.6)	45 (3.1)	843 (382)	1550 (703)	2550 (1156)	3920 (1778)	4900 (2222)
150 (10.3)	70 (4.9)	55 (3.8)	882 (400)	1620 (734)	2670 (1211)	4100 (1859)	5130 (2326)
	60 (4.2)	65 (4.5)	899 (407)	1650 (748)	2720 (1233)	4180 (1896)	5230 (2372)
	130 (8.9)	20 (1.4)	692 (313)	1270 (576)	2090 (948)	3220 (1460)	4030 (1828)
	120 (8.2)	30 (2.1)	821 (372)	1510 (684)	2480 (1124)	3820 (1732)	4780 (2168)
	110 (7.6)	40 (2.8)	912 (413)	1670 (757)	2760 (1251)	4240 (1923)	5300 (2404)
	100 (6.9)	50 (3.5)	976 (442)	1790 (811)	2950 (1338)	4540 (2059)	5680 (2576)
175 (12.1)	90 (6.3)	60 (4.2)	1020 (462)	1880 (852)	3090 (1401)	4760 (2159)	5950 (2698)
	80 (5.6)	70 (4.9)	1050 (476)	1930 (875)	3170 (1437)	4880 (2213)	6100 (2766)
	70 (4.9)	80 (5.6)	1060 (480)	1950 (884)	3210 (1456)	4940 (2240)	6180 (2803)
	150 (10.3)	25 (1.7)	830 (376)	1520 (689)	2510 (1138)	3860 (1750)	
	130 (8.9)	45 (3.1)	1040 (471)	1910 (866)	3150 (1428)	4840 (2195)	
	110 (7.6)	65 (4.5)	1160 (526)	2130 (966)	3510 (1592)	5400 (2449)	
200 (13.8)	90 (6.3)	85 (5.9)	1220 (553)	2240 (1016)	3680 (1669)	5660 (2567)	
	80 (5.6)	95 (6.6)	1230 (557)	2250 (1020)	3710 (1682)	5700 (2585)	
	170 (11.8)	30 (2.1)	959 (435)	1760 (798)	2900 (1315)	4460 (2023)	
	150 (10.3)	50 (3.5)	1170 (530)	2150 (975)	3540 (1605)	5440 (2467)	
250 (17.3)	130 (8.9)	70 (4.9)	1300 (589)	2390 (1084)	3930 (1782)	6040 (2739)	
	110 (7.6)	90 (6.3)	1370 (621)	2510 (1138)	4130 (1873)	6360 (2884)	
	100 (6.9)	100 (6.9)	1380 (625)	2540 (1152)	4170 (1891)	6420 (2912)	
	210 (14.5)	40 (2.8)	1220 (553)				
190 (13.1)	60 (4.2)	1430 (648)					
170 (11.8)	80 (5.6)	1570 (712)					
150 (10.3)	100 (6.9)	1660 (752)					
130 (8.9)	120 (8.2)	1700 (771)					
120 (8.2)	130 (8.9)	1710 (775)					

Regulators

Thermostatic Temperature Regulators (continued)
Series 1140 & 1141 (continued)

Body Code 05

- Steam or Water Service – For high steam pressure and/or high capacity applications.
- Stainless Steel Double Seat and Trim – Trim consists of seat rings and center guided plunger. Double seated valves have 1% allowable leakage rate.
- Body – 3/4" - 2" NPT – brass body, union ends
2 1/2" - 4" (65-100mm) – Iron body, flanged, faced and drilled for 125 lbs. (13.8 bar) standard
- Maximum Differential Pressure:
3/4" NPT – 250 psi (17.3 bar)
1" - 1 1/2" NPT – 200 psi (13.8 bar)
2" NPT – 150 psi (10.3 bar)
2 1/2" - 4" (65 - 100mm) – 125 psi (8.6 bar) (iron body, flanged)

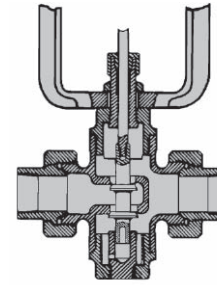

3/4" - 2" NPT

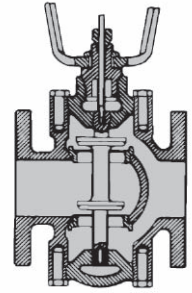

2 1/2" - 4" (65-100)

Regulators

Ordering Information - (For Assembled Body Bracket and Actuators)
Series 1140 Regulators (Cross ambient filled)

Size in. (mm)	Temperature Range								Weight (Approx.) lbs. (kg)
	40–80°F (4.4–27°C)	60–100°F (16–38°C)	80–120°F (27–49°C)	100–140°F (38–60°C)	120–160°F (49–71°C)	140–180°F (60–82°C)	160–200°F (71–93°C)	180–220°F (82–104°C)	
	Part Number								
3/4 NPT	400558 + 401350	400561 + 401350	400562 + 401350	400563 + 401350	400567 + 401350	400606 + 401350	400607 + 401350	400570 + 401350	15 (6.8)
1 NPT	400558 + 401353	400561 + 401353	400562 + 401353	400563 + 401353	400567 + 401353	400606 + 401353	400607 + 401353	400570 + 401353	18 (8.2)
1 1/4 NPT	400558 + 401356	400561 + 401356	400562 + 401356	400563 + 401356	400567 + 401356	400606 + 401356	400607 + 401356	400570 + 401356	19 (8.6)
1 1/2 NPT	400558 + 401359	400561 + 401359	400562 + 401359	400563 + 401359	400567 + 401359	400606 + 401359	400607 + 401359	400570 + 401359	22 (10.0)
2 NPT	400558 + 401362	400561 + 401362	400562 + 401362	400563 + 401362	400567 + 401362	400606 + 401362	400607 + 401362	400570 + 401362	28 (12.7)
2 1/2 (65)	400428 + 401365	400572 + 401365	400573 + 401365	400574 + 401365	400575 + 401365	400615 + 401365	400616 + 401365	400617 + 401365	88 (40)
3 (80)	400428 + 401368	400572 + 401368	400573 + 401368	400574 + 401368	400575 + 401368	400615 + 401368	400616 + 401368	400617 + 401368	95 (43)
4 (100)	400428 + 401371	400572 + 401371	400573 + 401371	400574 + 401371	400575 + 401371	400615 + 401371	400616 + 401371	400617 + 401371	125 (57)

Series 1141 Regulators (Non-cross ambient filled)

Do not use where ambient temperature exceeds set temperature control.

Size in.	Temperature Range				Weight (Approx.) lbs. (kg)
	120–160°F (49–71°C)	140–180°F (60–82°C)	160–200°F (71–93°C)	180–220°F (82–104°C)	
	Part Number				
3/4 NPT	400980 + 401350	400981 + 401350	400982 + 401350	400983 + 401350	15 (6.8)
1 NPT	400980 + 401353	400981 + 401353	400982 + 401353	400983 + 401353	18 (8.2)
1 1/4 NPT	400980 + 401356	400981 + 401356	400982 + 401356	400983 + 401356	19 (8.6)
1 1/2 NPT	400980 + 401359	400981 + 401359	400982 + 401359	400983 + 401359	22 (10.0)
2 NPT	400980 + 401362	400981 + 401362	400982 + 401362	400983 + 401362	28 (12.7)

Series 1140 & 1141 Wells

Part Number	Series	Material	Bulb Size (dia x length in (mm))	Weight lbs. (kg)
400445	1141	Copper	5/8 x 11 (16 x 280)	2 (.9)
401179	1140	Copper	7/8 x 18 (22 x 457)	2 (.9)
401181	1140	Copper	1 1/8 x 36 (29 x 914)	4 (1.8)
401180	1140	316 SS	7/8 x 18 (22 x 457)	3 (1.4)
405526	1140	316 SS	1 1/8 x 36 (29 x 914)	4 (1.8)

Series 1140 & 1141 (continued)
Capacities – Steam Flow, lbs./hr. (kg/hr.) vs Pressure Drop psi (bar)
Body Code 05 Direct Acting, Balanced Double Seated Valves

Size in.			¾ NPT	1 NPT	1¼ NPT	1½ NPT	2 NPT	2½ (65)	3 (88)	4 (100)
Pressure psi (bar)			Steam Flow lbs./hr. (kg/hr.)							
Inlet	Outlet	Drop								
3 (.2)	2 (.14)	1 (.07)	112 (50)	159 (72)	305 (138)	354 (160)	476 (215)	854 (387)	1090 (494)	2200 (997)
	1 (.07)	2 (.14)	155 (70)	218 (98)	420 (190)	487 (220)	655 (297)	1180 (535)	1500 (680)	3020 (1369)
5 (.35)	3 (.21)	2 (.14)	164 (74)	231 (104)	445 (201)	516 (234)	694 (314)	1250 (567)	1590 (721)	3200 (1451)
	2 (.14)	3 (.21)	195 (88)	276 (125)	530 (240)	615 (278)	827 (375)	1480 (671)	1880 (852)	3820 (1732)
10 (.7)	8 (.56)	2 (.14)	186 (84)	263 (119)	505 (229)	586 (265)	785 (356)	1410 (639)	1800 (816)	3640 (1651)
	6 (.42)	4 (.28)	251 (113)	355 (161)	683 (309)	792 (359)	1060 (480)	1910 (866)	2430 (1102)	4910 (2227)
	4 (.28)	6 (.42)	293 (132)	413 (187)	795 (360)	922 (418)	1240 (562)	2230 (1011)	2830 (1283)	5720 (2594)
15 (1.0)	12 (.83)	3 (.21)	247 (112)	348 (157)	670 (303)	777 (352)	1050 (476)	1880 (852)	2390 (1084)	4820 (2186)
	9 (.62)	6 (.42)	329 (149)	465 (210)	895 (405)	1040 (471)	1400 (635)	2510 (1138)	3190 (1446)	6440 (2921)
	6 (.42)	9 (.62)	376 (170)	532 (241)	1020 (462)	1190 (539)	1600 (725)	2560 (1161)	3640 (1651)	7360 (3338)
20 (1.4)	16 (1.1)	4 (.28)	305 (138)	432 (195)	830 (376)	963 (436)	1290 (585)	2320 (1052)	2950 (1338)	5980 (2712)
	12 (.83)	8 (.56)	403 (182)	569 (258)	1100 (498)	1270 (576)	1710 (775)	3070 (1392)	3900 (1769)	7880 (3574)
	8 (.56)	12 (.83)	455 (206)	644 (292)	1240 (562)	1440 (653)	1930 (875)	3470 (1573)	4410 (2000)	8910 (4041)
25 (1.7)	20 (1.4)	5 (.35)	363 (164)	514 (233)	988 (448)	1150 (521)	1540 (698)	2770 (1256)	3520 (1596)	7110 (3225)
	15 (1.0)	10 (.7)	476 (215)	672 (304)	1290 (585)	1500 (680)	2020 (916)	3620 (1642)	4600 (2086)	9310 (4223)
	10 (.7)	15 (1.0)	531 (240)	750 (340)	1440 (653)	1670 (752)	2250 (1020)	4040 (1832)	5140 (2331)	10400 (4717)
30 (2.1)	25 (1.7)	5 (.35)	389 (176)	550 (249)	1060 (480)	1230 (557)	1650 (748)	2960 (1342)	3760 (1705)	7610 (3451)
	20 (1.4)	10 (.7)	515 (233)	727 (329)	1400 (635)	1620 (734)	2180 (988)	3910 (1773)	4980 (2258)	10100 (4581)
	15 (1.0)	15 (1.0)	582 (264)	823 (373)	1580 (716)	1940 (879)	2470 (1120)	4430 (2009)	5630 (2553)	11400 (5171)
40 (2.8)	35 (2.4)	5 (.35)	435 (197)	615 (278)	1180 (535)	1370 (621)	1840 (834)	3310 (1501)	4210 (1909)	8510 (3860)
	30 (2.1)	10 (.7)	583 (264)	824 (373)	1590 (721)	1840 (834)	2470 (1120)	4440 (2013)	5640 (2558)	11400 (5171)
	20 (1.4)	20 (1.4)	727 (329)	1080 (489)	1980 (898)	2290 (1038)	3080 (1397)	5530 (2508)	7030 (3188)	14200 (6441)
50 (3.5)	40 (2.8)	10 (.7)	646 (293)	913 (414)	1760 (798)	2040 (925)	2740 (1242)	4910 (2227)	6250 (2835)	12600 (5715)
	30 (2.1)	20 (1.4)	825 (374)	1170 (530)	2240 (1016)	2600 (1179)	3500 (1587)	6250 (2835)	7980 (3619)	16100 (7302)
	20 (1.4)	30 (2.1)	890 (403)	1260 (571)	2420 (1097)	2810 (1274)	3780 (1714)	6780 (3075)	8620 (3910)	17400 (7892)
60 (4.1)	50 (3.5)	10 (.7)	702 (318)	992 (449)	1910 (866)	2210 (1002)	2900 (1315)	5340 (2422)	6790 (3079)	13700 (6214)
	40 (2.8)	20 (1.4)	913 (414)	1290 (585)	2480 (1124)	2880 (1306)	3870 (1755)	6940 (3147)	8830 (4005)	17900 (8119)
	30 (2.1)	30 (2.1)	1010 (458)	1430 (648)	2750 (1247)	3190 (1446)	4290 (1945)	7700 (3492)	9790 (4440)	19800 (8981)
70 (4.8)	60 (4.2)	10 (.7)	754 (342)	1070 (485)	2050 (929)	2380 (1079)	3200 (1451)	5740 (2603)	7300 (3311)	14800 (6713)
	50 (3.5)	20 (1.4)	994 (450)	1400 (635)	2700 (1224)	3130 (1419)	4210 (1909)	7560 (3429)	9610 (4359)	19400 (8799)
	40 (2.8)	30 (2.1)	1120 (508)	1590 (721)	3050 (1383)	3540 (1605)	4760 (2159)	8540 (3873)	10900 (4944)	22000 (9979)
	30 (2.1)	40 (2.8)	1170 (530)	1650 (748)	3180 (1442)	3680 (1669)	4950 (2245)	8890 (4032)	11300 (5125)	22900 (10387)
80 (5.5)	70 (4.9)	10 (.7)	803 (364)	1130 (512)	2180 (988)	2530 (1147)	3400 (1542)	6110 (2771)	7700 (3492)	15700 (7121)
	60 (4.2)	20 (1.4)	1070 (485)	1510 (684)	2900 (1315)	3360 (1524)	4520 (2050)	8210 (3724)	10300 (4672)	20900 (952)
	50 (3.5)	30 (2.1)	1210 (548)	1720 (780)	3300 (1496)	3830 (1737)	5150 (2336)	9240 (4191)	11700 (5307)	23800 (10795)
	40 (2.8)	40 (2.8)	1290 (585)	1820 (825)	3500 (1587)	4060 (1841)	5460 (2476)	9800 (4445)	12500 (5670)	25200 (11430)
90 (6.2)	80 (5.6)	10 (.7)	849 (385)	1200 (544)	2310 (1047)	2680 (1215)	3600 (1632)	6460 (2930)	8210 (3724)	16600 (7529)
	70 (4.9)	20 (1.4)	1130 (512)	1600 (725)	3080 (1397)	3570 (1619)	4800 (2177)	8610 (3905)	10900 (4944)	22100 (1024)
	60 (4.2)	30 (2.1)	1310 (594)	1850 (839)	3550 (1610)	4120 (1868)	5540 (2512)	9940 (4508)	12600 (5715)	25600 (11612)
	50 (3.5)	40 (2.8)	1410 (639)	1990 (902)	3830 (1737)	4440 (2013)	5970 (2708)	10700 (4835)	13600 (6168)	27500 (12474)
	40 (2.8)	50 (3.5)	1440 (653)	2040 (925)	3930 (1782)	4550 (2063)	6120 (2776)	11000 (4989)	14000 (6350)	28300 (12836)
100 (6.9)	90 (6.3)	10 (.7)	893 (405)	1260 (571)	2430 (1102)	2820 (1279)	3790 (1719)	6800 (3084)	8640 (3919)	17500 (7938)
	80 (5.6)	20 (1.4)	1210 (548)	1700 (771)	3280 (1487)	3800 (1723)	5110 (2317)	9170 (4159)	11700 (5307)	23600 (10704)
	70 (4.9)	30 (2.1)	1390 (630)	1960 (889)	3780 (1714)	4380 (1998)	5810 (2635)	10600 (4808)	13400 (6078)	27200 (12337)
	60 (4.2)	40 (2.8)	1510 (684)	2130 (966)	4100 (1859)	4760 (2159)	6400 (2903)	11500 (5216)	14600 (6622)	29500 (13381)
	50 (3.5)	50 (3.5)	1570 (712)	2220 (1007)	4280 (1941)	4960 (2249)	6670 (3025)	12000 (5443)	15200 (6894)	30800 (13970)
125 (8.6)	110 (7.6)	15 (1.0)	1200 (544)	1690 (766)	3250 (1474)	3770 (1710)	5070 (2299)	9100 (4127)	11600 (5261)	23400 (10614)
	100 (6.9)	25 (1.7)	1480 (671)	2090 (948)	4030 (1828)	4670 (2118)	6280 (2848)	11300 (5125)	14300 (6486)	29000 (13154)
	90 (6.3)	35 (2.4)	1670 (757)	2370 (1075)	4550 (2063)	5280 (2395)	7100 (3220)	12700 (5760)	16200 (7348)	32800 (14878)
	80 (5.6)	45 (3.1)	1800 (816)	2550 (1156)	4900 (2222)	5680 (2576)	7640 (3465)	13700 (6214)	17400 (7892)	35300 (16012)
	70 (4.9)	55 (3.8)	1890 (857)	2670 (1211)	5130 (2326)	5950 (2698)	8000 (3628)	14400 (6531)	18200 (8255)	36900 (16737)
	60 (4.2)	65 (4.5)	1920 (870)	2720 (1233)	5230 (2372)	6060 (2748)	8150 (3696)	14600 (6622)	18600 (8436)	37600 (17055)
150 (10.3)	130 (8.9)	20 (1.4)	1480 (671)	2090 (948)	4030 (1828)	4670 (2118)	6280 (2848)			
	120 (8.2)	30 (2.1)	1160 (526)	2480 (1124)	4780 (2168)	5540 (2512)	7450 (3379)			
	110 (7.6)	40 (2.8)	1950 (884)	2760 (1251)	5300 (2404)	6150 (2789)	8270 (3751)			
	100 (6.9)	50 (3.5)	2090 (948)	2950 (1338)	5650 (2562)	6580 (2984)	8850 (4014)			
	90 (6.3)	60 (4.2)	2190 (993)	3090 (1401)	5950 (2698)	6900 (3129)	9280 (4209)			
	80 (5.6)	70 (4.9)	2240 (1016)	3170 (1437)	6100 (2766)	7080 (3211)	9520 (4318)			
	70 (4.9)	80 (5.6)	2270 (1029)	3210 (1456)	6120 (2776)	7160 (3247)	9630 (4368)			
175 (12.1)	150 (10.3)	25 (1.7)	1780 (807)	2510 (1138)	4830 (2190)	5600 (2540)				
	130 (8.9)	45 (3.1)	2230 (1011)	3150 (1428)	6050 (2744)	7020 (3184)				
	110 (7.6)	65 (4.5)	2480 (1124)	3510 (1592)	6750 (3061)	7830 (3551)				
	90 (6.3)	85 (5.9)	2600 (1179)	3680 (1669)	7080 (3211)	8210 (3724)				
	80 (5.6)	95 (6.6)	2620 (1188)	3710 (1682)	7130 (3234)	8270 (3751)				
200 (13.8)	170 (11.8)	30 (2.1)	2080 (943)	2900 (1315)	5580 (2531)	6470 (2934)				
	150 (10.3)	50 (3.5)	2500 (1134)	3540 (1605)	6800 (3084)	7890 (3579)				
	130 (8.9)	70 (4.9)	2780 (1261)	3930 (1782)	7550 (3424)	8760 (3973)				
	110 (7.6)	90 (6.3)	2930 (1329)	4130 (1873)	7950 (3606)	9220 (4182)				
	100 (6.9)	100 (6.9)	2950 (1338)	4170 (1891)	8030 (3642)	9310 (4223)				
250 (17.3)	210 (14.5)	40 (2.8)	2610 (1183)							
	190 (13.1)	60 (4.2)	3050 (1383)							
	170 (11.8)	80 (5.6)	3360 (1524)							
	150 (10.3)	100 (6.9)	3540 (1605)							
	130 (8.9)	120 (8.2)	3630 (1646)							
	120 (8.2)	130 (8.9)	3650 (1655)							

Regulators

Thermostatic Temperature Regulators (continued)
Series 1140 & 1141 (continued)

Capacities — Water Flow vs Pressure Drop
Body Code 05 Direct Acting, Double Seated Valves

Regulators

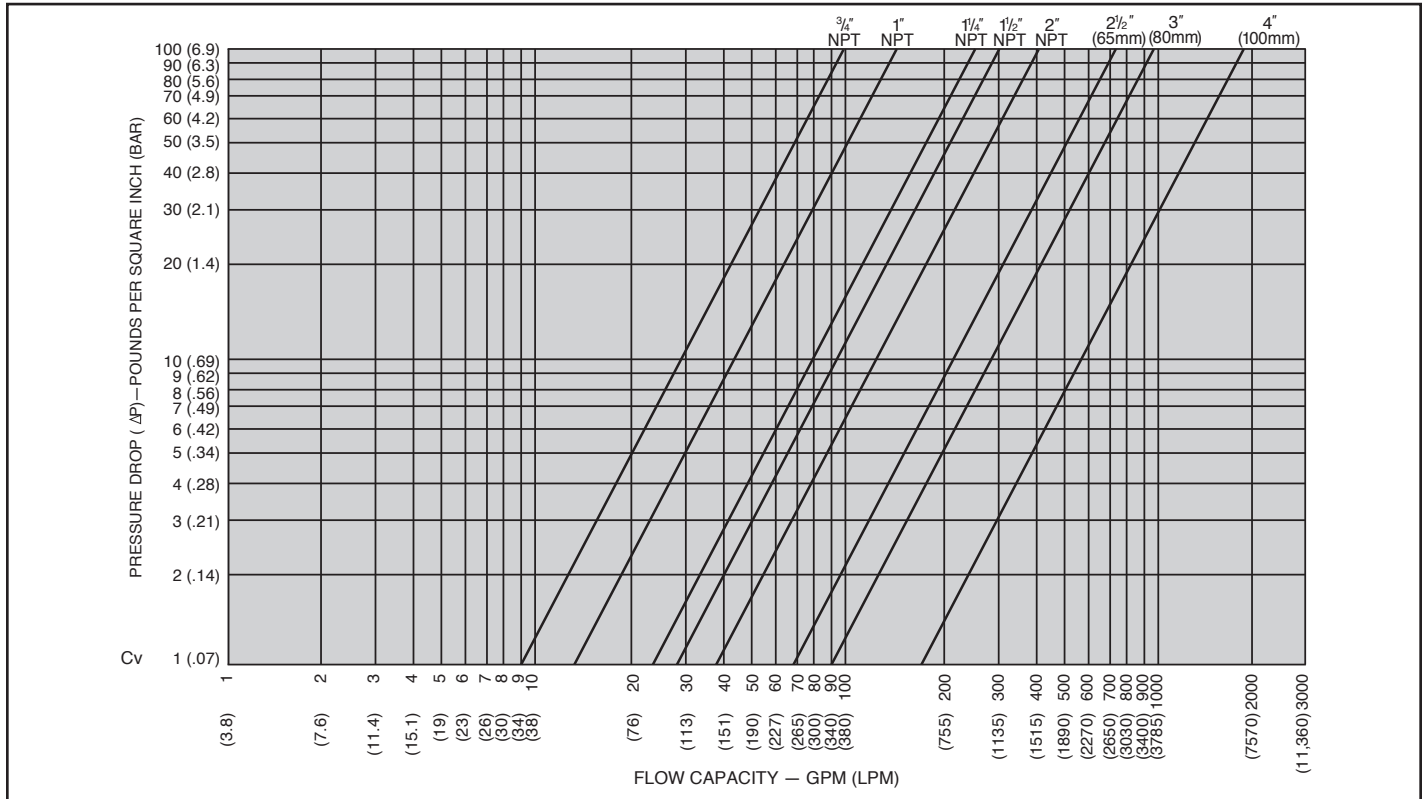

Series 1140 & 1141 (continued)

Reverse Acting

The Series 1140 and 1141 Reverse Acting Regulators are designed for commercial and institutional cooling

applications such as re-circulating lines, diesel engines, cooling towers, or others that require liquid temperature control.

Body Code 02R

- Steam or Water Service —
Used for general cooling service where dead end shut-off is required
- Stainless Steel Single Seat and Trim —
Trim consists of stainless steel seat ring and bottom guided disc
- Body—Brass body, union ends 3/4" - 2" NPT
- Maximum Differential Pressure:
 1/2" NPT – 125 psi (8.6 bar)
 3/4" NPT – 60 psi (4.1 bar)
 1" NPT – 32 psi (2.2 bar)
 1 1/4" NPT – 20 psi (1.4 bar)
 1 1/2" NPT – 16 psi (1.1 bar)
 2" NPT – 8 psi (.55 bar)

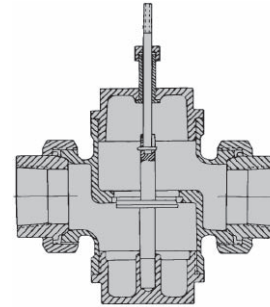

Ordering Information - (For Assembled Body Bracket and Actuator)

Series 1140 Regulators (Cross ambient filled)

Size in.	Temperature Range								Weight (Approx.) lbs. (kg)
	40–80°F (4.4–27°C)	60–100°F (16–38°C)	80–120°F (27–49°C)	100–140°F (38–60°C)	120–160°F (49–71°C)	140–180°F (60–82°C)	160–200°F (71–93°C)	180–220°F (82–104°C)	
Part Number									
1/2 NPT	400558 + 401312	400561 + 401312	400562 + 401312	400563 + 401312	400567 + 401312	400606 + 401312	400607 + 401312	400570 + 401312	14 (6.4)
3/4 NPT	400558 + 401311	400561 + 401311	400562 + 401311	400563 + 401311	400567 + 401311	400606 + 401311	400607 + 401311	400570 + 401311	15 (6.8)
1 NPT	400558 + 401313	400561 + 401313	400562 + 401313	400563 + 401313	400567 + 401313	400606 + 401313	400607 + 401313	400570 + 401313	18 (8.2)
1 1/4 NPT	400558 + 401314	400561 + 401314	400562 + 401314	400563 + 401314	400567 + 401314	400606 + 401314	400607 + 401314	400570 + 401314	19 (8.6)
1 1/2 NPT	400558 + 401317	400561 + 401317	400562 + 401317	400563 + 401317	400567 + 401317	400606 + 401317	400607 + 401317	400570 + 401317	22 (10.0)
2 NPT	400558 + 401320	400561 + 401320	400562 + 401320	400563 + 401320	400567 + 401320	400606 + 401320	400607 + 401320	400670 + 401320	28 (12.7)

Series 1141 Regulators (Non-cross ambient filled)

Do not use where ambient temperature exceeds set temperature control.

Size in.	Temperature Range				Weight (Approx.) lbs. (kg)
	120–160°F (49–71°C)	140–180°F (60–82°C)	160–200°F (71–93°C)	180–220°F (82–104°C)	
Part Number					
1/2 NPT	400980 + 401312	400981 + 401312	400982 + 401312	400983 + 401312	14 (6.4)
3/4 NPT	400980 + 401311	400981 + 401311	400982 + 401311	400983 + 401311	15 (6.8)
1 NPT	400980 + 401313	400981 + 401313	400982 + 401313	400983 + 401313	18 (8.2)
1 1/4 NPT	400980 + 401314	400981 + 401314	400982 + 401314	400983 + 401314	19 (8.6)
1 1/2 NPT	400980 + 401317	400981 + 401317	400982 + 401317	400983 + 401317	22 (10.0)
2 NPT	400980 + 401320	400981 + 401320	400982 + 401320	400983 + 401320	28 (12.7)

Series 1140 & 1141 Wells

Part Number	Series	Material	Bulb Size (dia x length in (mm))	Weight lbs. (kg)
400445	1141	Copper	5/8 x 11 (16 x 280)	2 (.9)
401179	1140	Copper	7/8 x 18 (22 x 457)	2 (.9)
401180	1140	316 SS	7/8 x 18 (22 x 457)	3 (1.4)

Thermostatic Temperature Regulators (continued)
Series 1140 & 1141 (continued)

Regulators

Body Code 05R

- Steam or Water Service
- Stainless Steel Trim — center guided plunger
- Body— $\frac{3}{4}$ " - 2" NPT—brass body, union ends
2 $\frac{1}{2}$ " - 4" (65-100mm)—Iron body, flanged, faced and drilled for 125lbs. (13.8 bar) standard
- Maximum Differential Pressure:
 $\frac{3}{4}$ " NPT — 250 psi (17.3 bar)
 1" - 2" NPT — 200 psi (13.8 bar)
 2 $\frac{1}{2}$ " - 4" (65 - 100mm) — 125 psi (8.6 bar) (iron body, flanged)

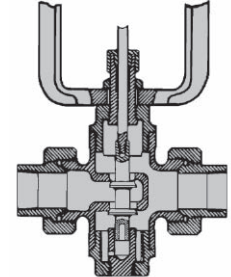

$\frac{3}{4}$ " - 2" NPT

Ordering Information - (For Assembled Body Bracket and Actuators)

Series 1140 Regulators (Cross ambient filled)

Size in. (mm)	Temperature Range								Weight (Approx.) lbs. (kg)
	40–80°F (4.4–27°C)	60–100°F (16–38°C)	80–120°F (27–49°C)	100–140°F (38–60°C)	120–160°F (49–71°C)	140–180°F (60–82°C)	160–200°F (71–93°C)	180–220°F (82–104°C)	
	Part Number								
$\frac{3}{4}$ NPT	400558 + 401377	400561 + 401377	400562 + 401377	400563 + 401377	400567 + 401377	400606 + 401377	400607 + 401377	400570 + 401377	15 (6.8)
1 NPT	400558 + 401380	400561 + 401380	400562 + 401380	400563 + 401380	400567 + 401380	400606 + 401380	400607 + 401380	400570 + 401380	18 (8.2)
1 $\frac{1}{4}$ NPT	400558 + 401383	400561 + 401383	400562 + 401383	400563 + 401383	400567 + 401383	400606 + 401383	400607 + 401383	400570 + 401383	19 (8.6)
1 $\frac{1}{2}$ NPT	400558 + 401386	400561 + 401386	400562 + 401386	400563 + 401386	400567 + 401386	400606 + 401386	400607 + 401386	400570 + 401386	22 (10.0)
2 NPT	400558 + 401389	400561 + 401389	400562 + 401389	400563 + 401389	400567 + 401389	400606 + 401389	400607 + 401389	400570 + 401389	28 (12.7)
2 $\frac{1}{2}$ (65)	400428 + 401392	400572 + 401392	400573 + 401392	400574 + 401392	400575 + 401392	400615 + 4401392	400616 + 401392	400617 + 401392	88 (40)
3 (80)	400428 + 401387	400572 + 401387	400573 + 401387	400574 + 401387	400575 + 401387	400615 + 401387	400616 + 401387	400617 + 401387	95 (43)
4 (100)	400428 + 401395	400572 + 401395	400573 + 401395	400574 + 401395	400575 + 401395	400615 + 401395	400616 + 401395	400617 + 401395	125 (57)

Series 1141 Regulators (Non-cross ambient filled)

Do not use where ambient temperature exceeds set temperature control.

Size in.	Temperature Range				Weight (Approx.) lbs. (kg)
	120–160°F (49–71°C)	140–180°F (60–82°C)	160–200°F (71–93°C)	180–220°F (82–104°C)	
	Part Number				
$\frac{3}{4}$ NPT	400980 + 401377	400981 + 401377	400982 + 401377	400983 + 401377	15 (6.8)
1 NPT	400980 + 401380	400981 + 401380	400982 + 401380	400983 + 401380	18 (8.2)
1 $\frac{1}{4}$ NPT	400980 + 401383	400981 + 401383	400982 + 401383	400983 + 401383	19 (8.6)
1 $\frac{1}{2}$ NPT	400980 + 401386	400981 + 401386	400982 + 401386	400983 + 401386	22 (10.0)
2 NPT	400980 + 401389	400981 + 401389	400982 + 401389	400983 + 401389	28 (12.7)

Series 1140 & 1141 Wells

Part Number	Series	Material	Bulb Size (dia x length in (mm))	Weight lbs. (kg)
400445	1141	Copper	$\frac{5}{8}$ x 11 (16 x 280)	2 (.9)
401179	1140	Copper	$\frac{7}{8}$ x 18 (22 x 457)	2 (.9)
401181	1140	Copper	1 $\frac{1}{8}$ x 36 (29 x 914)	4 (1.8)
401180	1140	316 SS	$\frac{7}{8}$ x 18 (22 x 457)	3 (1.4)

Series 1140 & 1141 (continued)

Capacities — Water Flow vs Pressure Drop
Body Code 05R Reverse Acting, Double Seated Valves

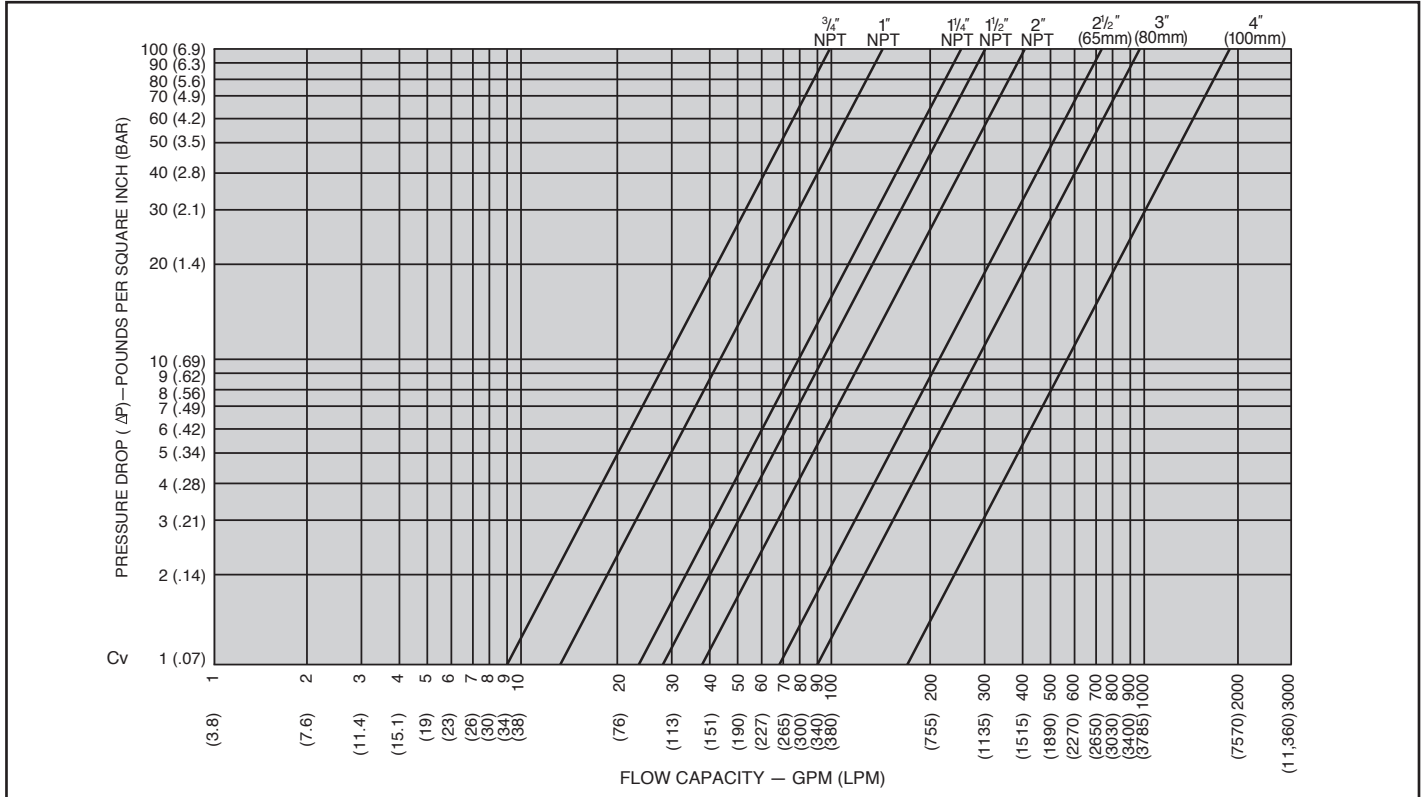

Regulators

Thermostatic Temperature Regulators (continued)

Series 1140 & 1141 (continued)

Three Way

The Series 1140 and 1141 Three Way Regulators are designed for commercial and institutional applications

such as boilers, engines, or others that require mixing, tempering, or diverting liquids at a set temperature.

Body Code 06

- Water Service Only
- Nickel Plated Piston, Brass Trim — Sliding piston
- Body — 1/2" - 2" NPT — brass body, union ends, bottom connection screwed 2 1/2" - 4" (65-100mm) — iron body, flanged, faced and drilled for 125 lbs. (13.8 bar) standard
- Maximum Pressure 250 psig (17.3 bar)
- Maximum Differential Pressure:
1/2" - 3/4" NPT — 250 psi (17.3 bar)
1" - 2" NPT — 200 psi (13.8 bar)
2 1/2" - 4" (65 - 100mm) — 125 psi (8.6 bar)
- Maximum Body Temperature — 350°F (177°C)

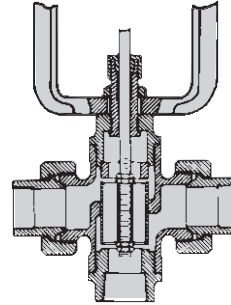

1/2" - 2" NPT

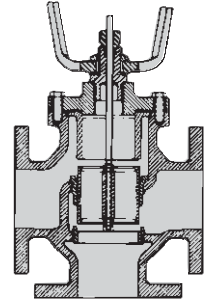

2 1/2" - 4" (65 - 100)

Ordering Information - (For Assembled Body Bracket and Actuators)

Series 1140 Regulators (Cross ambient filled)

Size in. (mm)	Temperature Range								Weight (Approx.) lbs. (kg)
	40–80°F (4.4–27°C)	60–100°F (16–38°C)	80–120°F (27–49°C)	100–140°F (38–60°C)	120–160°F (49–71°C)	140–180°F (60–82°C)	160–200°F (71–93°C)	180–220°F (82–104°C)	
Part Number									
1/2 NPT	400558 + 401396	400561 + 401396	400562 + 401396	400563 + 401396	400567 + 401396	400606 + 401396	400607 + 401396	400570 + 401396	14 (6.4)
3/4 NPT	400558 + 401397	400561 + 401397	400562 + 401397	400563 + 401397	400567 + 401397	400606 + 401397	400607 + 401397	400570 + 401397	15 (6.8)
1 NPT	400558 + 401398	400561 + 401398	400562 + 401398	400563 + 401398	400567 + 401398	400606 + 401398	400607 + 401398	400570 + 401398	18 (8.2)
1 1/4 NPT	400558 + 401399	400561 + 401399	400562 + 401399	400563 + 401399	400567 + 401399	400606 + 401399	400607 + 401399	400570 + 401399	19 (8.6)
1 1/2 NPT	400558 + 401400	400561 + 401400	400562 + 401400	400563 + 401400	400567 + 401400	400606 + 401400	400607 + 401400	400570 + 401400	22 (10.0)
2 NPT	400558 + 401401	400561 + 401401	400562 + 401401	400563 + 401401	400567 + 401401	400606 + 401401	400607 + 401401	400570 + 401401	28 (12.7)
2 1/2 (65)	400428 + 401402	400572 + 401402	400573 + 401402	400574 + 401402	400575 + 401402	400615 + 401402	400616 + 401402	400617 + 401402	88 (40)
3 (80)	400428 + 401403	400572 + 401403	400573 + 401403	400574 + 401403	400575 + 401403	400615 + 401403	400616 + 401403	400617 + 401403	95 (43)
4 (100)	400428 + 401404	400572 + 401404	400573 + 401404	400574 + 401404	400575 + 401404	400615 + 401404	400616 + 401404	400617 + 401404	125 (57)

Series 1141 Regulators (Non-cross ambient filled)

Do not use where ambient temperature exceeds set temperature control.

Size in.	Temperature Range				Weight (Approx.) lbs. (kg)
	120–160°F (49–71°C)	140–180°F (60–82°C)	160–200°F (71–93°C)	180–220°F (82–104°C)	
Part Number					
1/2 NPT	400980 + 401396	400981 + 401396	400982 + 401396	400983 + 401396	14 (6.4)
3/4 NPT	400980 + 401397	400981 + 401397	400982 + 401397	400983 + 401397	15 (6.8)
1 NPT	400980 + 401398	400981 + 401398	400982 + 401398	400983 + 401398	18 (8.2)
1 1/4 NPT	400980 + 401399	400981 + 401399	400982 + 401399	400983 + 401399	19 (8.6)
1 1/2 NPT	400980 + 401400	400981 + 401400	400982 + 401400	400983 + 401400	22 (10.0)
2 NPT	400980 + 401401	400981 + 401401	400982 + 401401	400983 + 401401	28 (12.7)

Series 1140 & 1141 Wells

Part Number	Series	Material	Bulb Size (dia x length in (mm))	Weight lbs. (kg)
400445	1141	Copper	5/8 x 11 (16 x 280)	2 (.9)
401179	1140	Copper	7/8 x 18 (22 x 457)	2 (.9)
401181	1140	Copper	1 1/8 x 36 (29 x 914)	4 (1.8)
401180	1140	316 SS	7/8 x 18 (22 x 457)	3 (1.4)
405526	1140	316 SS	1 1/8 x 36 (29 x 914)	4 (1.8)

Series 1140 & 1141 (continued)

Capacities — Water Flow vs Pressure Drop

Body Code 06 Three Way Valves

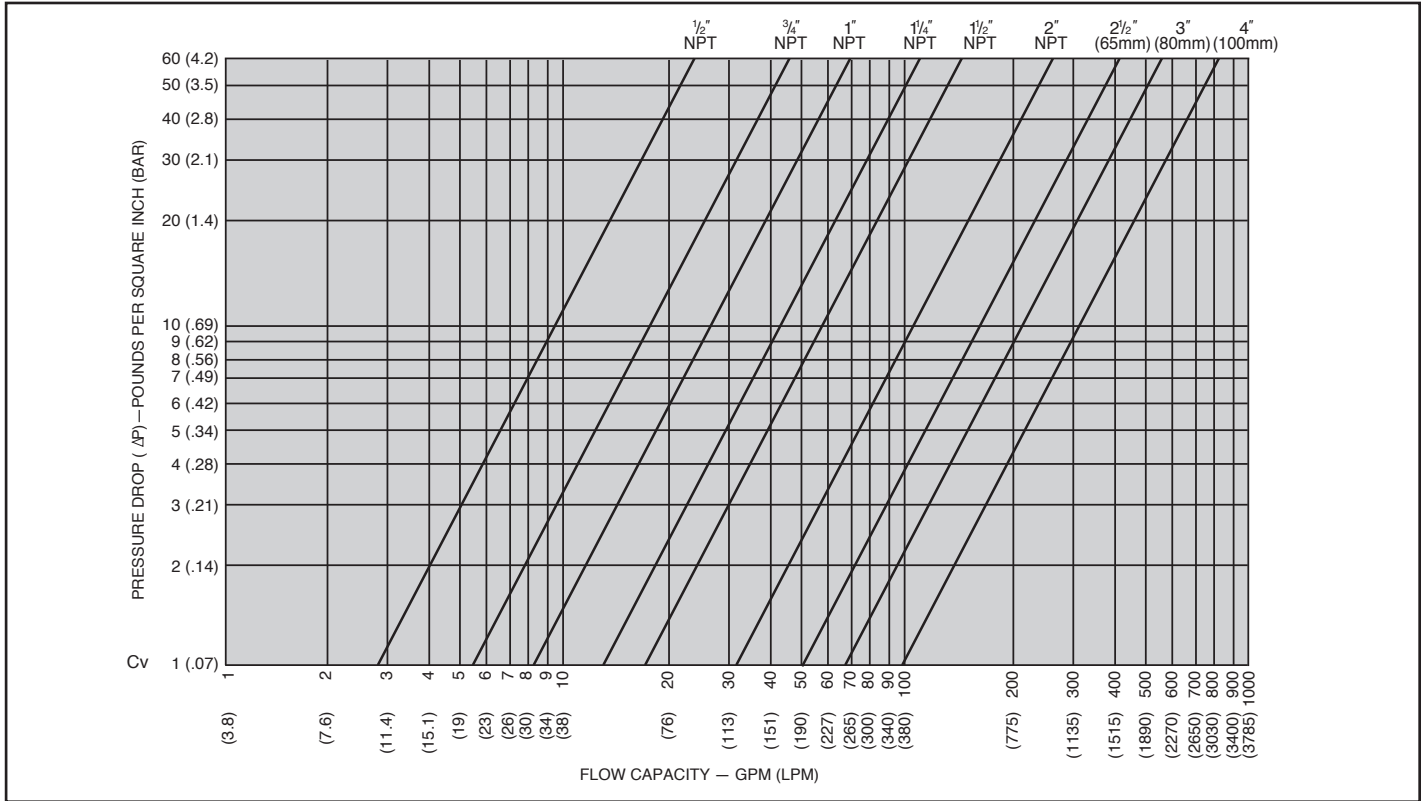

Regulators

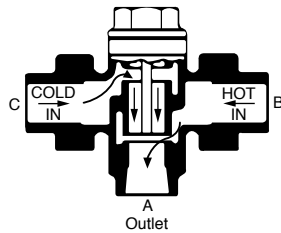

**Series 1140 & 1141
3-way valve
mixing service**

When temperature increases piston moves down closing port 'B' opening port 'C'.

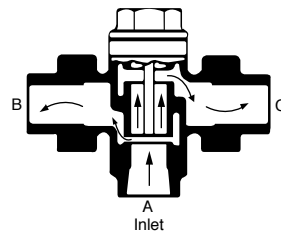

**Series 1140 & 1141
3-way valve
diverting service**

When temperature increases piston moves down closing port 'B' opening port 'C'.

Tempering Valves

Series 21

Hoffman Specialty Tempering Valves are designed to control temperature in water mixing applications such as radiant floor heating, hot water heating and industrial processing. They can also be used to divert flow in cooling

systems. Series 21 Valves can be used for residential, industrial, commercial or institutional applications.

Series 21

- Fast acting, corrosion resistant actuator
- Solid filled thermostatic actuator exerts high operating force and provides reliable service
- Easy temperature adjustment
- No special tools required
- Cast brass body
- Adjustable temperature ranges
 Model 21 140–200°F (60–93°C)
 Model 21H 100–200°F (38–93°C)
 Model 21LT 100–140°F (38–60°C)
- Maximum pressure 125 psig (8.6 bar)
- Maximum hot water supply temperature 235°F (113°C)

Model 21 provides wide temperature adjustment range for hot and cold water mixing.

Model 21H provides widest temperature adjustment range for radiant heating applications where accurate temperature control is less critical.

Model 21LT provides the greatest accuracy of temperature control.

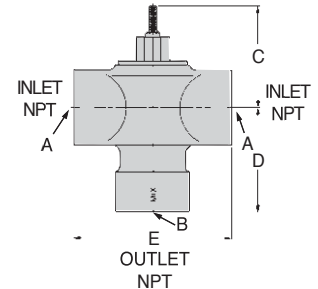

Dimensions in. (mm)

NPT Size In. A	NPT Size In. B	C	D	E
3/4	3/4	2 3/4 (70)	1 7/8 (48)	3 3/4 (95)
1	1	2 3/4 (70)	2 (50)	4 (102)
1 1/4	1 1/4	3 7/8 (98)	3 7/8 (98)	5 1/4 (133)
1 1/2	1 1/2	3 7/8 (98)	3 7/8 (98)	5 1/4 (133)
2	2	3 7/8 (98)	3 7/8 (98)	6 (152)

CAUTION

Series 21 Tempering Valves contain leaded brass and must not be used for potable water service.

WARNING

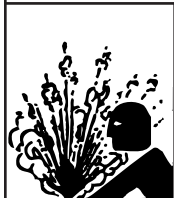

Do not use Tempering Valves as anti-scald devices. Tempering valves may need to be used in conjunction with an anti-scald device. Failure to follow this warning could cause serious burns, personal injury or death.

Series 21 (continued)

Capacities

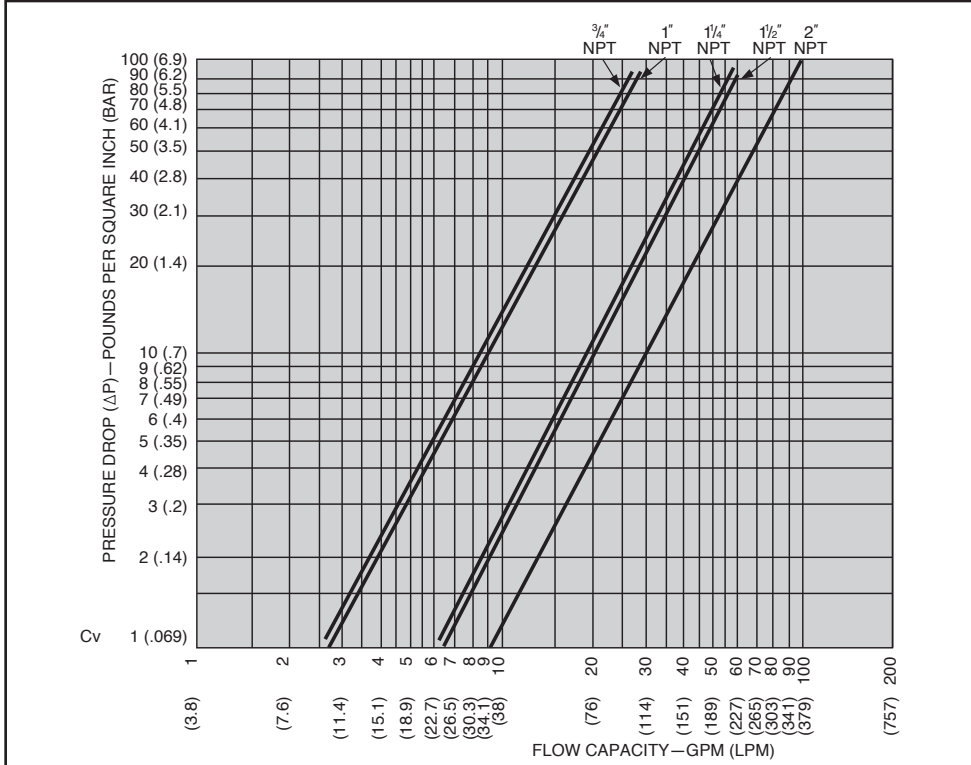

Regulators

Ordering Information

Adjustable range of 140 to 200°F (60 to 93°C). Maximum supply temperature 235°F (113°C).

Model Number	Part Number	NPT Size in.	Weight lbs. (kg)
21	401239	3/4	3 (1.4)
21	401242	1	3 (1.4)
21	401245	1 1/4	6 (2.7)
21	401248	1 1/2	7 (3.2)
21	401251	2	9 (4.1)

Adjustable range of 100 to 200°F (38 to 93°C). Maximum supply temperature 235°F (113°C).

Model Number	Part Number	NPT Size in.	Weight lbs. (kg)
21H	401024	3/4	3 (1.4)
21H	401030	1	3 (1.4)
21H	401033	1 1/4	6 (2.7)
21H	401048	1 1/2	7 (3.2)
21H	401102	2	9 (4.1)

Adjustable range of 100 to 140°F (38 to 60°C). Maximum supply temperature 235°F (113°C).

Model Number	Part Number	NPT Size in.	Weight lbs. (kg)
21LT	401281	3/4	3 1/2 (1.6)
21LT	401284	1	3 1/2 (1.6)
21LT	401287	1 1/4	6 1/2 (2.9)
21LT	401290	1 1/2	7 1/2 (3.4)
21LT	401293	2	9 1/2 (4.3)

Thermostatic Temperature Regulators (continued) Series 21 Applications

Panel Heating Installation

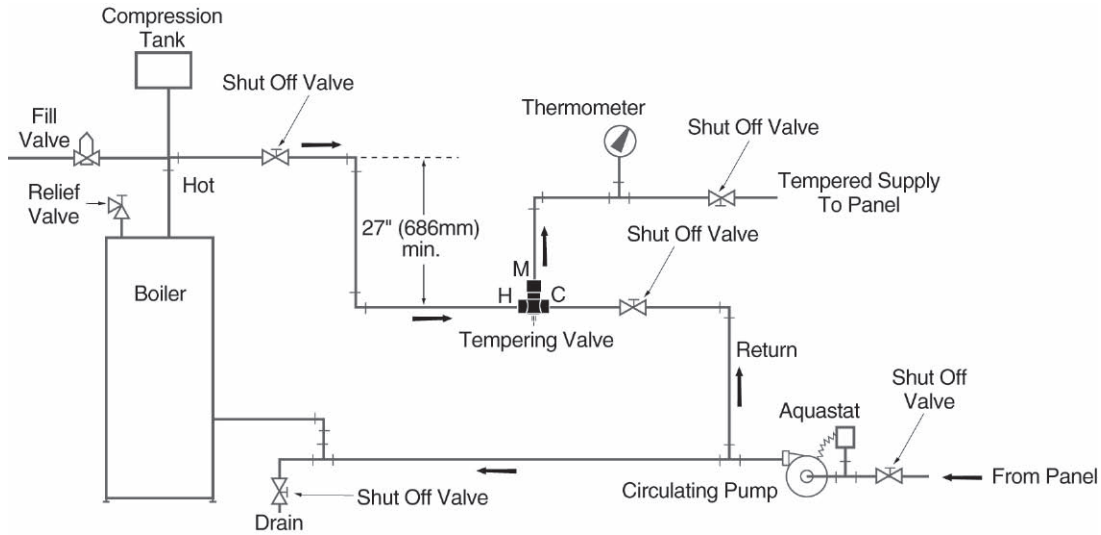

Note: Circulating pump, illustrated in the above application, circulate tempered water through the system. The aquastat shuts the circulating pump off if the tempered water exceeds the temperature set point, which is normally $\pm 5^{\circ}\text{F}$ ($\pm 2^{\circ}\text{C}$) of the tempering valve discharge.

Thermostatic Temperature Regulators (continued)
Series 21 (continued)

Engine Jacket Temperature Control Installation

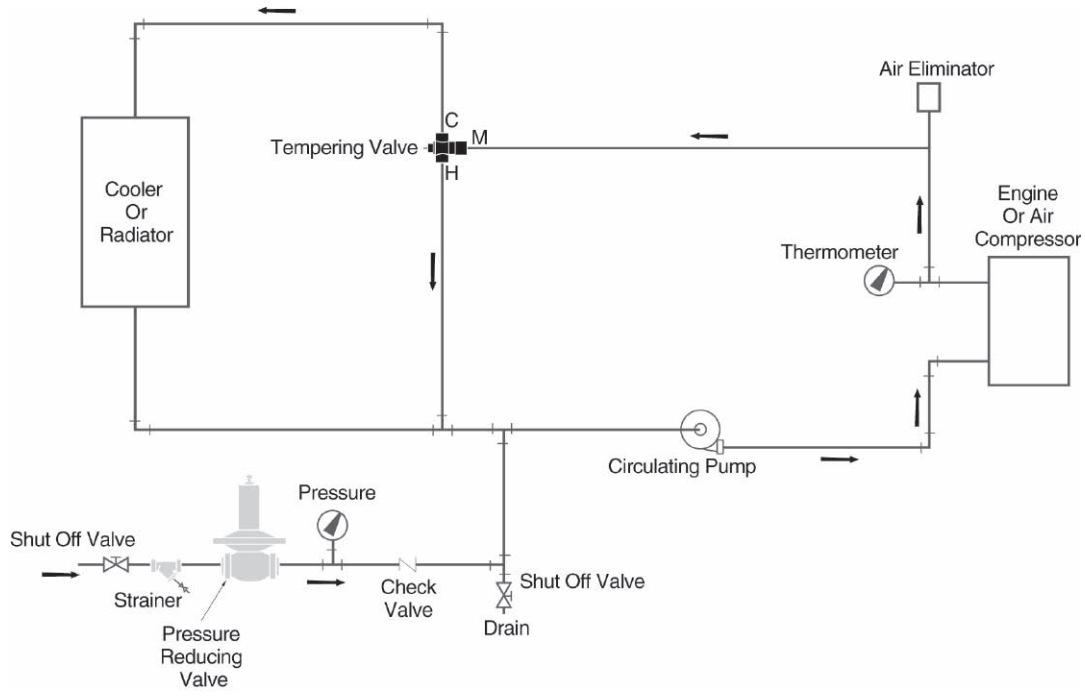

Radiant Heating Installation

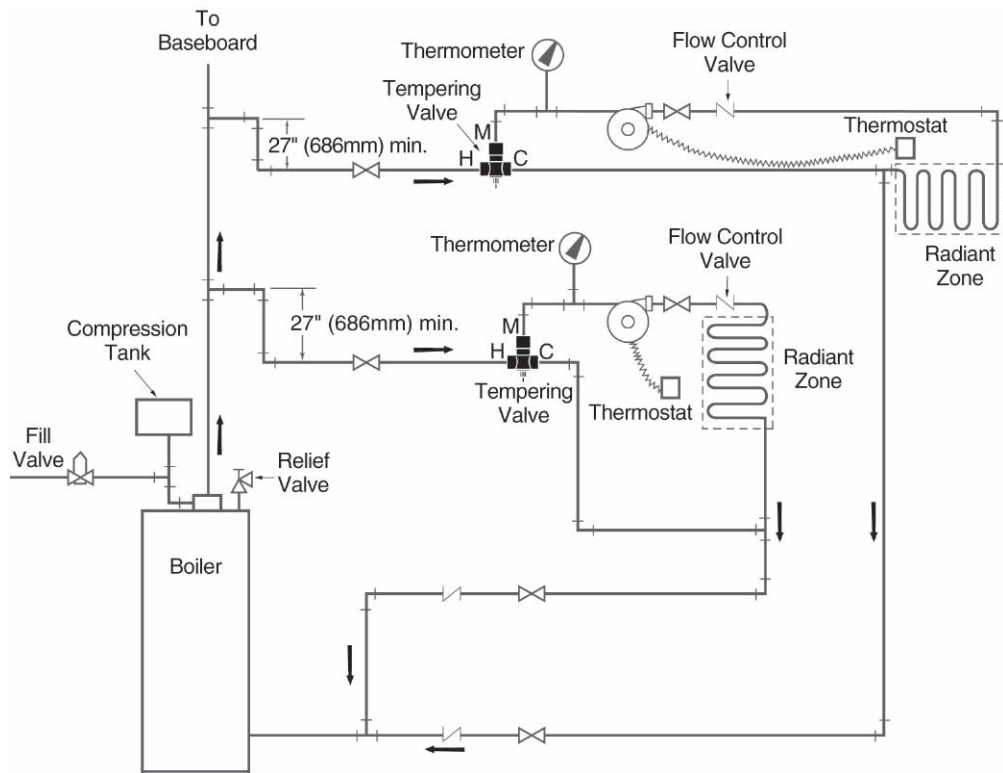

Regulators

Vacuum Breakers

Model 62 Part No. 401446

- For use on closed vessels and piping systems to control induced vacuum within safe limits
- Adjustable from 1/4" - 20" (8-508mm) Hg vacuum - factory set at 2" (51mm) Hg vacuum
- 3/4" NPT straight shank
- Maximum operating temperature 366°F (186°C)
- Maximum operating pressure 150 psig (10.3 bar)

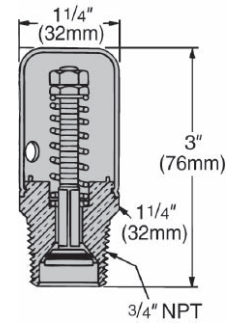

Vacuum Breakers

Typical Installations

Hot Water Converter

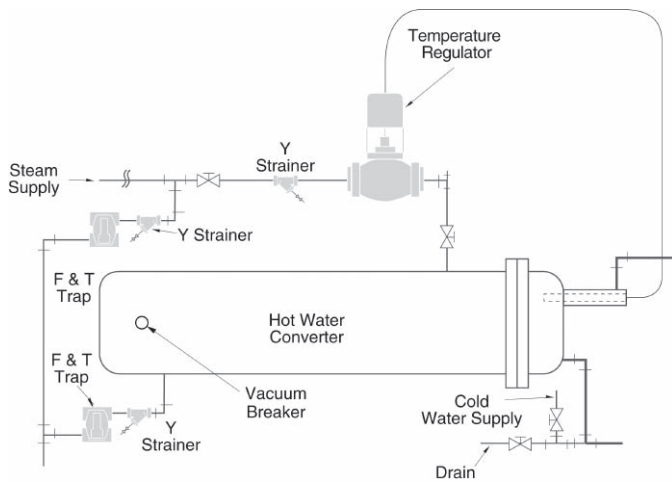

Storage Tank Water Heater

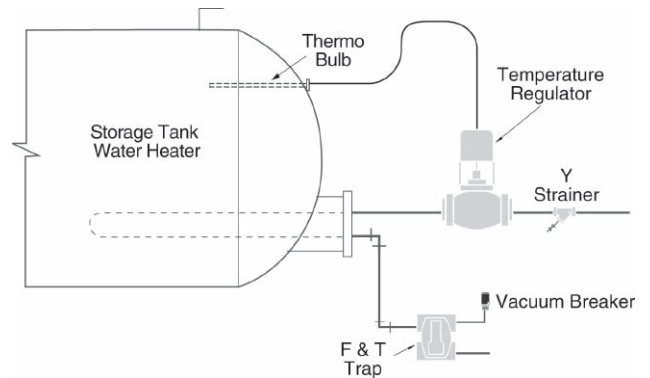

Tankless Water Heater

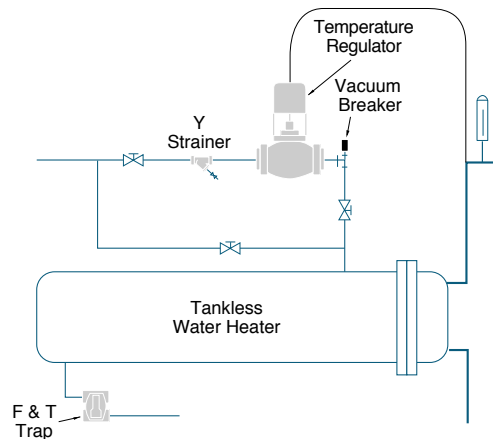

Main Steam Vents

How to Select Steam Vents

Model Number	Radiator (Angle Type)	Convactor (Bottom Inlet)	Unit Heater	Mains	Thermostatic Vent (only)	Remarks
1A	X					Adjustable Orifice
70A	X					Fixed Orifice
40	X					Fixed Orifice
1B		X				Adjustable Orifice
41		X				Fixed Orifice
43		X				Fixed Orifice
45		X				Fixed Orifice
71A		X				Fixed Orifice
71B		X				Fixed Orifice
71C		X				Fixed Orifice
508		X				Moisture Type
4A				X		Small Systems
75				X		Low Pressure
75H				X		High Pressure
76				X		Vacuum Systems
3					X	Paul Systems
74			X			Unit Heaters
4					X	Small Systems
8C					X	High Pressure

Vents

Model 4A Part No. 401413

Air Valve (non-vacuum)

- Float-type thermostatic vent
- For residential or small one-pipe or two-pipe systems
- Single non-adjustable port
- ½" NPT female and ¾" NPT male straight shank
- Install 6-10" (150-250mm) above horizontal return and 18" (450mm) above the boiler water line
- Maximum operating pressure 2 psig (0.13 bar)*
- Maximum pressure 10 psig (0.7 bar)



Air Valve
Model 4A

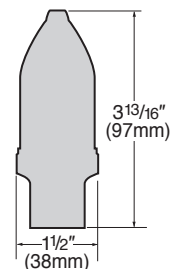

Model 75 Part No. 401434

75H Part No. 401437

Air Valve (non-vacuum)

- Float-type thermostatic vent
- For medium and large systems
- Single non-adjustable port
- ½" NPT female and ¾" NPT male straight shank
- Maximum operating pressure*
 - Model 75 3 psig (0.2 bar)
 - Model 75H 10 psig (0.7 bar)
- Maximum pressure 15 psig (1.0 bar)



Air Valve
Model 75 & 75H

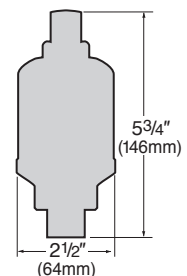

*Drop away pressure (maximum pressure against which the vent can open).

Model 76 Part No. 401432

Vacuum Valve

- Float-type thermostatic vent
- For medium and large one-pipe vacuum systems
- Single non-adjustable port
- ½" NPT female and ¾" NPT male straight shank
- Install 6-10" (150-250mm) above horizontal return and 8" (450mm) above the boiler water line
- Maximum operating pressure 3 psig (0.2 bar)
- Maximum pressure 15 psig (1.0 bar)



**Vacuum Valve
Model 76**

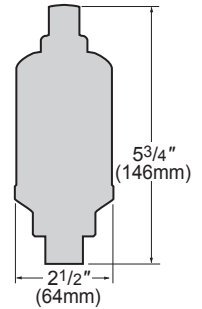

Installation

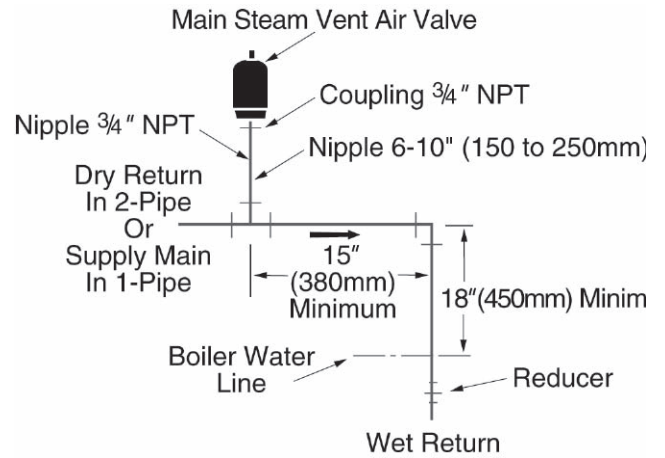

Vents

To prevent steam vents from sputtering water or damage from water hammer, observe the minimum elevations shown.

High Pressure Steam Vent

Model 8C Angle Part No. 402002
High Pressure Balanced Pressure Air Valve

- Thermostatic vent (no float)
- Install at the high point in piping or on equipment to quickly vent air from the steam space.
- Discharge may be piped to a safe area or into vented return line.
- 1/4" (6mm) orifice
- Inlet 1/2" NPT male union connection
- Outlet 1/2" NPT female
- Bronze body and cap
- Stainless steel element
- Maximum operating pressure 125 psig (8.6 bar)



Model 8C Angle
1/2" NPT

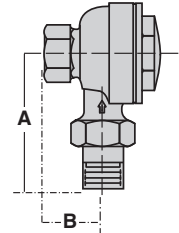

Vents

Dimensions, in. (mm)

Model	Pattern	NPT Size	A	B
8C-2	Angle	1/2	2 ²⁷ / ₃₂ (72)	1 ¹ / ₄ (32)

Air make up coil with F&T Float & Thermostatic trap draining into a wet return line

Note: A separate thermostatic trap is added to vent air into the dry return line.

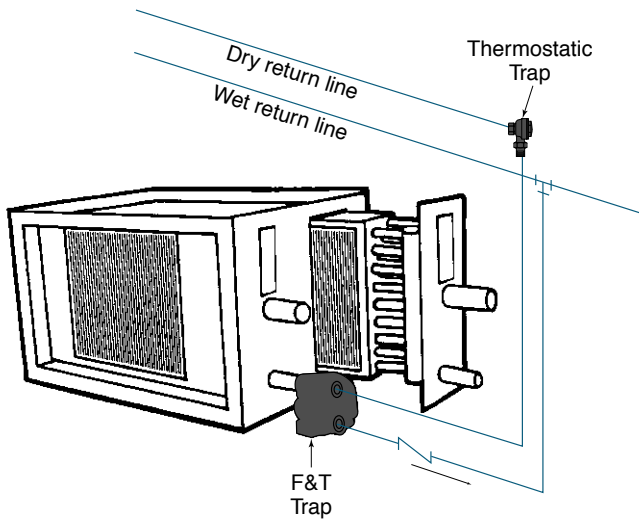

Special Steam Vents

Model 3 Part No. 401419

Steam Air Line Valve

- Thermostatic vent (no float)
- For Air Line or Paul Systems
- Inlet 1/8" NPT, outlet 1/4" NPT
- Maximum operating pressure 25 psig (1.7 bar)* to vacuum
- Maximum pressure 25 psig (1.7 bar)



**Steam Air Line Valve
Model 3**

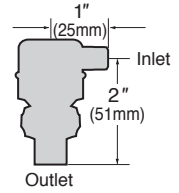

Model 74 Part No. 401429

Steam Unit Heater Air Valve

- Float-type thermostatic vent
- Single non-adjustable port
- 1/2" NPT female and 3/4" NPT male straight shank
- Install 6-10" (150-250mm) above horizontal return and 18" (450mm) above the boiler water line
- Maximum operating pressure 35 psig (2.4 bar)*
- Maximum pressure 35 psig (2.4 bar)



**Steam Unit Heater
Air Valve
Model 74**

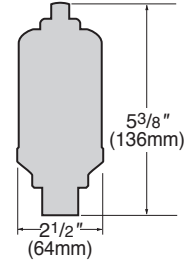

Installation

Model 74

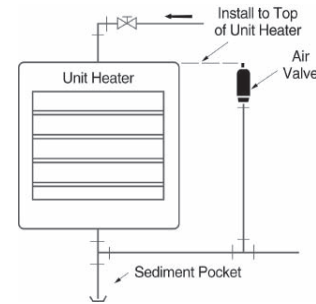

Model 4 Part No. 401416

Quick Valve

- Thermostatic air vent
- For steam systems and process equipment
- Operates on temperature change only; does not close against water
- Must be installed 6-10" (150-250mm) above horizontal return and 18" (450mm) above the boiler water line
- 1/2" NPT female and 3/4" NPT male straight shank
- Maximum operating pressure 25 psig (1.7 bar)*
- Maximum pressure 25 psig (1.7 bar)



**Quick Valve
Model 4**

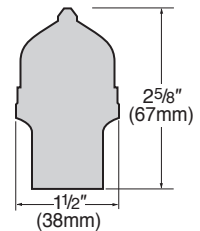

Installation

Model 4

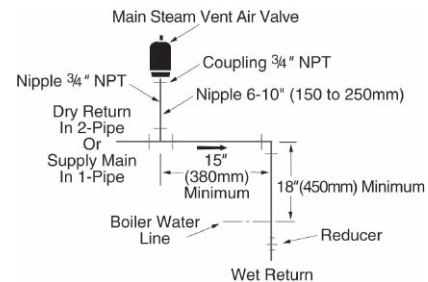

To prevent steam vents from sputtering water or damage from water hammer, observe the minimum elevations shown.

*Drop away pressure (maximum pressure against which the vent can open).

Radiator Steam Vents

Model 1A Part No. 401422

Air Valve (non-vacuum)

- Float-type vent
- Adjustable port for true proportional venting – 6 port settings from slow (1) to fast (6)
- 1/8" NPT angle connection
- Maximum operating pressure 1 1/2 psig (0.1 bar)*
- Maximum pressure 10 psig (0.7 bar)



**Air Valve
Model 1A**

Model 70A Part No. 401443

Air Valve (non-vacuum)

- Float-type vent
- Single non-adjustable port
- Meets Federal Specification WW-V-151 for Type 1 Non-Adjustable Valves
- 1/8" NPT angle connection
- Maximum operating pressure 11 psig (0.8 bar)*
- Maximum pressure 15 psig (1.0 bar)



**Air Valve
Model 70A**

Model 40 Part No. 401440

Air Valve (non-vacuum)

- Float-type vent
- For ordinary one-pipe system that doesn't require proportional venting
- Single non-adjustable port
- 1/8" NPT angle connection
- Maximum operating pressure 6 psig (0.4 bar)*
- Maximum pressure 10 psig (0.7 bar)



**Air Valve
Model 40**

Vents

Typical Installation

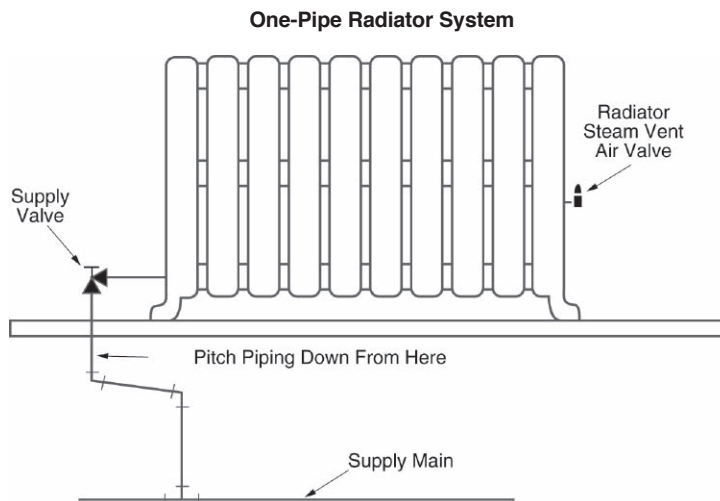

*Drop away pressure (maximum pressure against which the vent can open).

Convactor Steam Vents

Model 1B Part No. 401425

Air Valve (non-vacuum)

- Float-type vent
- Adjustable port for true proportional venting – 6 port settings from slow (1) to fast (6)
- Telescopic siphon tube
- ¼" NPT straight shank
- Maximum operating pressure 1½ psig (0.1 bar)*
- Maximum pressure 10 psig (0.7 bar)



**Air Valve
Model 1B**

Model 41 Part No. 401455

43 Part No. 401458

45 Part No. 401461

Air Valve (non-vacuum)

- Single non-adjustable port
- For small steam systems
- Telescopic siphon tube with angle cut assures drainage
- ½" NPT straight shank (41)
- ¼" NPT straight shank (43)
- ½" NPT female and ¾" NPT male straight shank (45)
- Maximum operating pressure 6 psig (0.4 bar)*
- Maximum pressure 10 psig (0.7 bar)



**Air Valve
Model 41, 43, 45**

Model 71A Part No. 401470

71B Part No. 401464

71C Part No. 401467

Air Valve (non-vacuum)

- Float-type vent
- Single non-adjustable port
- Meets Federal Specification WW-V-151 for Type 1 Non-Adjustable Valves
- Telescopic siphon tube with angle cut assures drainage
- ½" NPT straight shank (71A)
- ¼" NPT straight shank (71B)
- ½" NPT female and ¾" NPT male straight shank (71C)
- Maximum operating pressure 11 psig (0.8 bar)*
- Maximum pressure 15 psig (1.0 bar)



**Air Valve
Model 71A, 71B, 71C**

*Drop away pressure (maximum pressure against which the vent can open).

Water Vents

How to Select Water Vents

Model Number	Radiator	Convactor	Mains	Built-in Vacuum Check	Maximum Operating Pressure psig (bar)	Remarks
77	X	X			50 (3.5)	Small Systems
78			X	X	150 (10.3)	High Pressure
79			X	X	75 (5.2)	Low Pressure
790		X			30 (2.1)	Small Systems
791		X	X		50 (3.5)	Small Systems
792			X		250 (17.3)	Cast Iron Body
550		X			100 (6.9)	Air Chamber
508	X	X			50 (3.5)	Moisture Type

Model 77 Part No. 401497

Water Vent Valve

- For efficient releasing of air in hydronic heating systems, such as baseboard radiators, convactor radiators and small heating units
- 1/8" NPT straight shank
- Maximum operating pressure 50 psig (3.5 bar)*
- Maximum temperature 240°F (116°C)



Water Vent Valve
Model 77

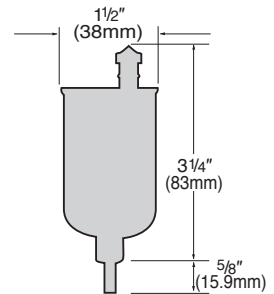

Model 78 Part No. 401485

Water Main Vent Valve

- For use on high pressure hot or cold water or glycol mains and process applications with specific gravity greater than 0.7
- Cast brass body
- Tapped at top for 1/8" NPT safety drain connection for discharging moisture
- Body unscrews for easy cleaning
- Built-in Check Valve
- 3/4" NPT straight shank
- Maximum operating pressure 150 psig (10.3 bar)*
- Maximum hydrostatic pressure 450 psig (31.1 bar)
- Maximum temperature 250°F (121°C)



Water Main Vent Valve
Model 78

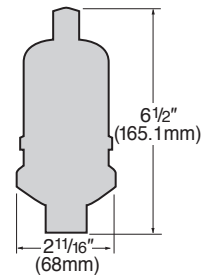

Model 79 Part No. 401488

Water Main Vent Valve

- For use on hot or cold or glycol water mains and process applications with specific gravity greater than 0.7
- Tapped at top for 1/8" NPT safety drain connection for discharging moisture
- Removable top
- Built-in Check Valve
- 1/2" NPT female and 3/4" NPT male straight shank
- Maximum operating pressure 75 psig (5.2 bar)*
- Maximum hydrostatic pressure 200 psig (13.8 bar)
- Maximum temperature 250°F (121°C)



Water Main Vent Valve
Model 79

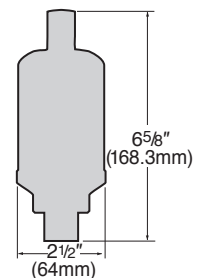

*Drop away pressure (maximum pressure against which the vent can open).

Model 790 Part No. 401479

Water Vent Valve

- For removing air from convectors, baseboard and wall radiation
- Safety drain connection for discharging moisture
- Fitting and ferrule for 3/8" (4.8mm) OD tubing
- Telescopic siphon tube
- 1/8" NPT straight shank
- Maximum operating pressure 30 psig (2.1 bar)*
- Maximum pressure 30 psig (2.1 bar)

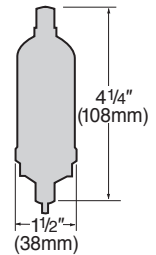

**Water Vent Valve
Model 790**

Model 791 Part No. 401482

Water Vent Valve

- For convectors and small mains
- Safety drain connection for discharging moisture
- Fitting and ferrule for 3/8" (4.8mm) OD tubing
- Telescopic siphon tube
- 1/4" NPT straight shank
- Maximum operating pressure 50 psig (3.5 bar)*
- Maximum pressure 50 psig (3.5 bar)

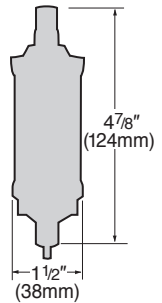

**Water Vent Valve
Model 791**

Model 792 Part No. 401494

High Pressure Water Vent Valve

- For releasing air from hot or cold water or glycol mains, hydronic heating and chilling systems, storage and processing tank filters, centrifugal pumps with specific gravity greater than 0.7
- Cast iron body and cover, stainless steel interior
- Maximum operating pressure 250 psig (17.3 bar)*
- Maximum hydrostatic pressure 350 psig (24.2 bar)
- Maximum temperature 300°F (149°C)

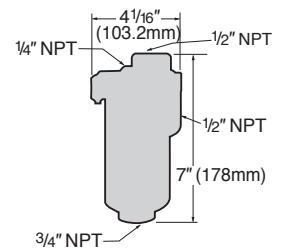

**High Pressure
Water Vent Valve
Model 792**

Model 792 Capacity	
Water Pressure psig (bar)	Air Discharge to Atmosphere cu. ft./min. (cu. m/min.)
100 (6.9)	10 (.28)
150 (10.3)	15 (.42)
200 (13.8)	20 (.57)
250 (17.3)	25 (.70)

*Maximum pressure against which the vent can open.

Model 550 Part No. 401476

Air Chamber

- For use on convectors which are not provided with built-in air chambers or air collection fittings
- Brass construction.
- ¼" NPT straight shank connection tapped at the top for ¼" NPT connection
- 6 cubic inch (98.3cm) volume
- Maximum water pressure 100 psig (6.9 bar)
- Maximum steam pressure 25 psig (1.7 bar)



**Air Chamber
Model 550**

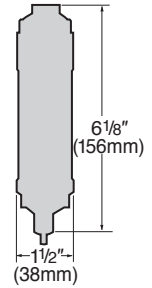

Model 508 Part No. 401475

Water Vent Valve

- For automatic or manual venting systems
- Ideal for use with Model 550 Air Chamber
- Disc-type vent
- Built-in check valve
- Cartridge with discs can be replaced without draining the system
- ¼" NPT straight shank
- Maximum water pressure 50 psig (3.5 bar)
- Maximum pressure 50 psig (3.5 bar)



**Water Vent Valve
Model 508**

Drain Valves

Model 793 Part No. 401500, 150 psig (10.3 bar)
Part No. 401503, 250 psig (17.3 bar)

Drain Valve

- Automatically removes water from compressed air tanks, air separators and after-coolers
- Minimum air loss
- ½" NPT outlet, ½" NPT side inlet, ¾" NPT top inlet
- Cast iron body and cover, stainless steel interior
- Maximum pressure 250 psig (17.3 bar)
- Maximum hydrostatic pressure 350 psig (24.2 bar)



**Drain Valve
Model 793**

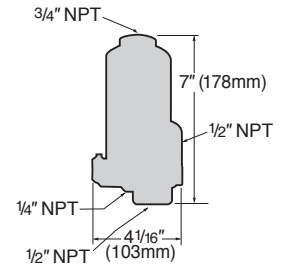

CAPACITY:

Discharge Orifice

- for operating pressures up to 150 psig (10.3 bar), 3/32" (2.4mm) seat
- for operating pressures over 150 psig (10.3 bar), 5/64" (2mm) seat

Model 793 Capacity		
Pressure psig (bar)	lbs. of water/hr. (kg of water/hr)	
	3/32" (2.4mm) Orifice	5/64" (2mm) Orifice
250 (17.3)	—	900 (408)
200 (13.8)	—	800 (360)
150 (10.3)	1200 (545)	690 (315)
125 (8.6)	1100 (500)	630 (285)
100 (6.9)	975 (442)	570 (258)
80 (5.5)	870 (394)	510 (231)
50 (3.5)	690 (312)	400 (181)
30 (2.1)	530 (240)	315 (143)
15 (1.0)	375 (170)	220 (100)

Supply Valves

Model 185C

Radiator Supply Valve

- Suitable for hot water, cold water or steam
- Brass / bronze construction
- Non-rising stem; packless construction
- Available in angle and straight pattern design
- Sizes from 1/2" to 2"
- Maximum working pressure: 150 PSIG
- Maximum temperature: 400° F

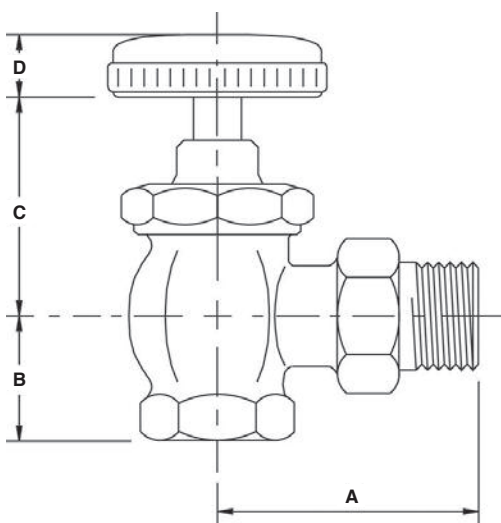

Angle Pattern

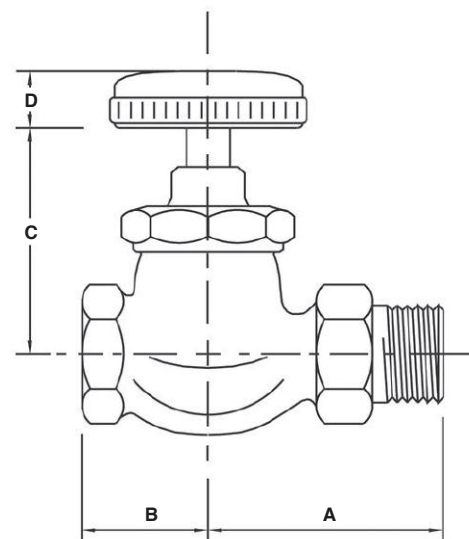

Straight Pattern

Model 185C Dimensional Data (inches)						
Part Number	Style	Size	A	B	C	D
405099	Angle	1/2	2-3/8	1-3/16	2-3/16	7/8
405102	Angle	3/4	2-7/8	1-3/16	2-3/16	7/8
405105	Angle	1	3-1/8	1-1/2	2-5/16	1
405108	Angle	1-1/4	3-1/2	1-3/4	2-5/8	1
405111	Angle	1-1/2	3-7/8	1-15/16	2-13/16	1-1/8
405144	Angle	2	4-3/8	2-3/8	3-1/4	1-1/8
405114	Straight	1/2	2-3/8	1-3/8	2-11/16	7/8
405117	Straight	3/4	2-7/8	1-3/8	2-13/16	7/8
405120	Straight	1	3-1/8	1-11/16	3-1/16	1
405123	Straight	1-1/4	3-5/8	2	3-9/16	1
405126	Straight	1-1/2	3-7/8	2-3/8	3-7/8	1-1/8
407051	Straight	2	4-3/8	2-3/4	4-1/2	1-1/8

Y-Strainers

Y-Strainers are designed for steam, oil or water lines. Strainers should be installed ahead of temperature regulating and/or pressure reducing valves and steam

traps to protect their moving parts from dirt, this is particularly important for new installations.

Screwed NPT End

Model 415C

- Cast iron body
- Maximum pressure:
 - 250 psig (17.3 bar) for steam service
 - 400 psig (27.6 bar) for water service
- Available in sizes ½" - 3" NPT



Screwed NPT End Y-Strainer

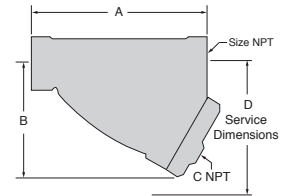

Model 420C

- Cast brass body
- Maximum pressure:
 - 300 psig (20.6 bar) for steam service
 - 400 psig (27.6 bar) for water service
- Available in sizes ½" - 3" NPT

Dimensions in. (mm)

Model 415C

Part Number	A	B	NPT C	D
405000	3 ¹ / ₄ (83)	2 ¹ / ₈ (54)	1/4	3 ¹ / ₄ (83)
405003	3 ³ / ₄ (95)	2 ⁹ / ₁₆ (65)	3/8	3 (76)
405006	4 ¹ / ₃₂ (102)	2 ⁵ / ₁₆ (58)	3/8	3 ¹ / ₄ (83)
405009	5 ¹ / ₃₂ (128)	3 ¹ / ₄ (83)	3/4	6 (152)
405012	5 ³ / ₄ (146)	3 ⁷ / ₈ (98)	3/4	6 (152)
405015	7 ¹ / ₁₆ (179)	4 ³ / ₄ (121)	1	6 ³ / ₄ (171)
405018	9 ¹⁵ / ₁₆ (237)	5 ⁷ / ₈ (149)	1 ¹ / ₄	7 ⁷ / ₈ (200)
405022	10 (254)	6 ¹ / ₃₂ (153)	1 ¹ / ₄	8 (203)

Model 420C

Part Number	A	B	NPT C	D
405024	2 ¹⁵ / ₁₆ (71)	1 ¹³ / ₁₆ (30)	1/4	3 (76)
405027	3 ⁵ / ₈ (92)	2 (51)	1/4	4 (102)
405030	4 ⁷ / ₁₆ (113)	2 ⁵ / ₈ (67)	3/8	4 ¹ / ₂ (114)
405033	5 ¹ / ₈ (130)	3 ³ / ₈ (86)	3/8	5 (127)
405036	5 ³ / ₄ (146)	3 ⁷ / ₁₆ (87)	1/2	5 ³ / ₄ (146)
405039	7 ¹ / ₄ (184)	4 ³ / ₄ (111)	1/2	6 ¹ / ₂ (165)
405042	8 ¹ / ₄ (210)	6 ³ / ₄ (171)	1 ¹ / ₄	-
405045	9 ⁵ / ₈ (244)	6 ¹ / ₄ (159)	1 ¹ / ₄	-

Ordering Information

Model Number	Part Number	NPT Size	Wt lbs. (kg)
415C	405000	1/2	1 (0.5)
415C	405003	3/4	2.5 (1.1)
415C	405006	1	3.5 (1.6)
415C	405009	1 1/4	5.5 (2.5)
415C	405012	1 1/2	8 (3.6)
415C	405015	2	13 (5.9)
415C	405018	2 1/2	22 (10)
415C	405022	3	30 (13.6)
420C	405024	1/2	1 (0.5)
420C	405027	3/4	1.6 (0.7)
420C	405030	1	2.1 (1)
420C	405033	1 1/4	2.8 (1.3)
420C	405036	1 1/2	4.5 (2.0)
420C	405036	2	7 (3.2)
420C	405042	2 1/2	2 (10)
420C	405045	3	35 (16)

Specifications

Model	Body Material	Steam Service			Water Service		
		Pressure psig (bar)	Temperature °F (°C)	Screen Material Mesh SS	Pressure psig (bar)	Temperature °F (°C)	Screen Material Mesh SS
415C	Cast Iron	250 (17.3)	400 (204)	20	400 (28)	150 (66)	20
420C	Cast Brass	300 (20.6)	400 (204)	20	400 (28)	150 (66)	20

Y-Strainers (continued)

Flanged End

Model 450C

- Cast iron body
- Maximum pressure: 125 psig (8.6 bar) for steam
200 psig (13.8 bar) for water
- Available in sizes 2½" - 8" (65-200mm)

Model 460A, 460B

- Cast iron body
- Maximum pressure: 250 psig (17.3 bar) for steam
500 psig (35 bar) for water
- Available in sizes 2½" - 8" (65-200mm)

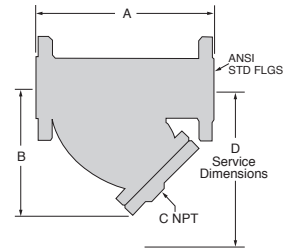

Flanged End Y-Strainer

Dimensions, in. (mm)

Model 450C

Part Number	A	B	NPT C	D
405324	10 (254)	6½ (165)	1	9¾ (248)
405327	10⅛ (257)	6¾ (171)	1	10 (254)
405330	12⅛ (307)	8 (203)	1½	12 (305)
405333	15⅝ (397)	10½ (267)	2	15½ (394)
405336	18½ (470)	13½ (343)	2	20 (508)
405339	21⅝ (549)	15¼ (387)	2	22¾ (578)

Model 460B

Part Number	A	B	NPT C	D
405303	11⅛ (283)	7 (178)	1	10¼ (260)
405306	12¾ (324)	8¼ (210)	1¼	12¼ (311)

Model 460A

Part Number	A	B	NPT C	D
405309	15¼ (387)	10½ (267)	1½	15¼ (387)
405317	17⅝ (448)	12¾ (324)	2	19 (483)
405315	19⅝ (498)	14½ (368)	2	22½ (572)
405318	25 (635)	16 (406)	2	23½ (597)

Ordering Information

Model Number	Part Number	Flanged Size in. (mm)	Weight Approx. lbs. (kg)
450C	405324	2½ (65)	33 (15)
450C	405327	3 (80)	47 (21)
450C	405330	4 (100)	80 (36)
450C	405333	5 (125)	109 (49)
450C	405336	6 (150)	152 (69)
450C	405339	8 (200)	247 (112)
460B	405303	2½ (65)	45 (21)
460A	405309	4 (100)	100 (45)
460A	405317	5 (120)	150 (68)
460A	405315	6 (150)	210 (95)
460A	405318	8 (200)	350 (159)

Specifications

Model	Flanged Size in. (mm)	Flange Rating psig (bar)	Body Material	Steam Service			Water Service		
				Pressure psig (bar)	Temp. °F (°C)	Screen Material Perf. SS in. (mm)	Pressure psig (bar)	Temp. °F (°C)	Screen Material Perf. SS in. (mm)
450C	2 ½ - 4 (65-100)	125 (8.6)	Cast Iron	125 (8.6)	450 (232)	.045 (1.1)	200 (13.8)	150 (66)	.062 (1.6)
450C	5 - 8 (125-200)	125 (8.6)	Cast Iron	125 (8.6)	450 (232)	.062 (1.6)	200 (13.8)	150 (66)	.125 (3.2)
460B	2 ½ - 3 (65-80)	250 (17.3)	Cast Iron	250 (17.3)	450 (232)	.062 (1.6)	500 (35)	150 (66)	.062 (1.6)
460A	4 (100)	250 (17.3)	Cast Iron	250 (17.3)	450 (232)	.062 (1.6)	500 (35)	150 (66)	.062 (1.6)
460A	5 - 8 (125-200)	250 (17.3)	Cast Iron	250 (17.3)	450 (232)	.062 (1.6)	500 (35)	150 (66)	.125 (3.2)

Capacities – Water Flow vs Pressure Drop

Screwed End Y-Strainers

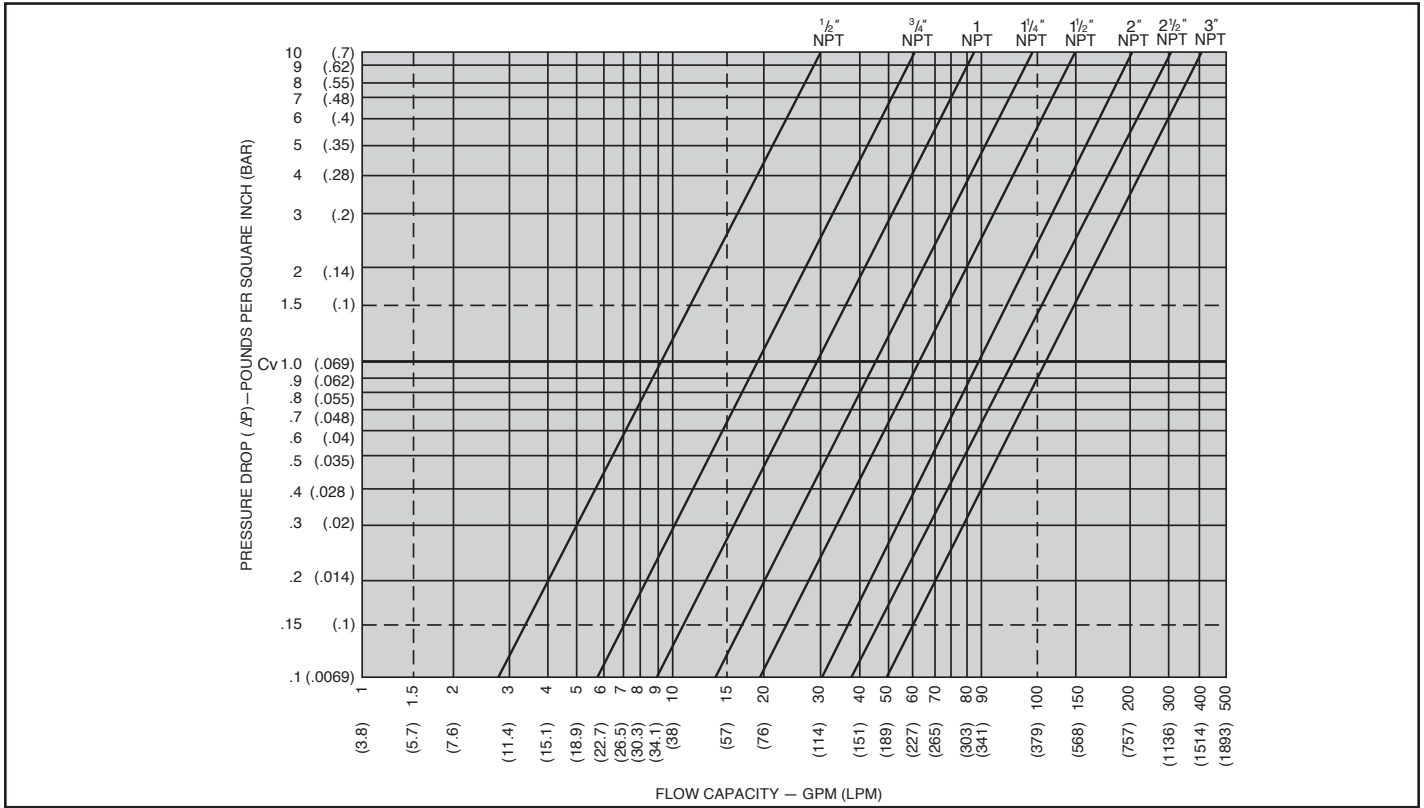

Flanged End Y-Strainers

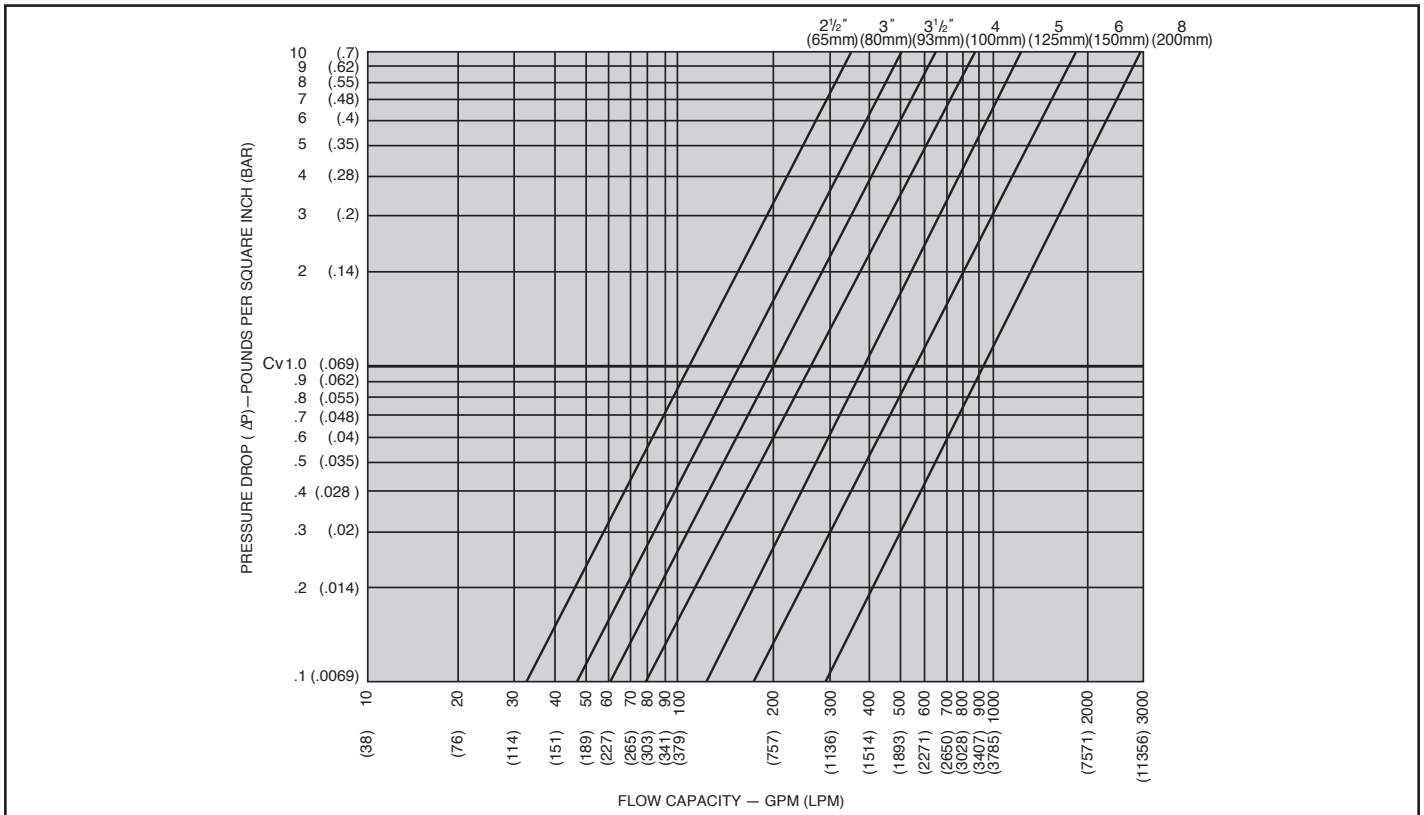

Reference Tables and Formulas

Table 1 - Properties of Saturated Steam

Pressure psig	Temp. °F	Heat in BTU/lb.			Specific Volume Cu. ft. per lb.
		Sensible	Latent	Total	
25	134	102	1017	1119	142
20	162	129	1001	1130	73.9
15	179	147	990	1137	51.3
10	192	160	982	1142	39.4
5	203	171	976	1147	31.8
0	212	180	970	1150	26.8
1	215	183	968	1151	25.2
2	219	187	966	1153	23.5
3	222	190	964	1154	22.3
4	224	192	962	1154	21.4
5	227	195	960	1155	20.1
6	230	198	959	1157	19.4
7	232	200	957	1157	18.7
8	233	201	956	1157	18.4
9	237	205	954	1159	17.1
10	239	207	953	1160	16.5
12	244	212	949	1161	15.3
14	248	216	947	1163	14.3
16	252	220	944	1164	13.4
18	256	224	941	1165	12.6
20	259	227	939	1166	11.9
22	262	230	937	1167	11.3
24	265	233	934	1167	10.8
26	268	236	933	1169	10.3
28	271	239	930	1169	9.85
30	274	243	929	1172	9.46
32	277	246	927	1173	9.10
34	279	248	925	1173	8.75
36	282	251	923	1174	8.42
38	284	253	922	1175	8.08
40	286	256	920	1176	7.82
42	289	258	918	1176	7.57
44	291	260	917	1177	7.31
46	293	262	915	1177	7.14
48	295	264	914	1178	6.94
50	298	267	912	1179	6.68
55	300	271	909	1180	6.27
60	307	277	906	1183	5.84
65	312	282	901	1183	5.49
70	316	286	898	1184	5.18
75	320	290	895	1185	4.91
80	324	294	891	1185	4.67
85	328	298	889	1187	4.44
90	331	302	886	1188	4.24
95	335	305	883	1188	4.05
100	338	309	880	1189	3.89
105	341	312	878	1190	3.74
110	344	316	875	1191	3.59
115	347	319	873	1192	3.46
120	350	322	871	1193	3.34
125	353	325	868	1193	3.23
130	356	328	866	1194	3.12
140	361	333	861	1194	2.92
145	363	336	859	1195	2.84

Pressure psig	Temp. °F	Heat in BTU/lb.			Specific Volume Cu. ft. per lb.
		Sensible	Latent	Total	
150	366	339	857	1196	2.74
155	368	341	855	1196	2.68
160	371	344	853	1197	2.60
165	373	346	851	1197	2.54
170	375	348	849	1197	2.47
175	377	351	847	1198	2.41
180	380	353	845	1198	2.34
185	382	355	843	1198	2.29
190	384	358	841	1199	2.24
195	386	360	839	1199	2.19
200	388	362	837	1199	2.14
205	390	364	836	1200	2.09
210	392	366	834	1200	2.05
215	394	368	832	1200	2.00
220	396	370	830	1200	1.96
225	397	372	828	1200	1.92
230	399	374	827	1201	1.89
235	401	376	825	1201	1.85
240	403	378	823	1201	1.81
245	404	380	822	1202	1.78
250	406	382	820	1202	1.75
255	408	383	819	1202	1.72
260	409	385	817	1202	1.69
265	411	387	815	1202	1.66
270	413	389	814	1203	1.63
275	414	391	812	1203	1.60
280	416	392	811	1203	1.57
285	417	394	809	1203	1.55
290	418	395	808	1203	1.53
295	420	397	806	1203	1.49
300	421	398	805	1203	1.47
305	423	400	803	1203	1.45
310	425	402	802	1204	1.43
315	426	404	800	1204	1.41
320	427	405	799	1204	1.38
325	429	407	797	1204	1.36
330	430	408	796	1204	1.34
335	432	410	794	1204	1.33
340	433	411	793	1204	1.31
345	434	413	791	1204	1.29
350	435	414	790	1204	1.28
355	437	416	789	1205	1.26
360	438	417	788	1205	1.24
365	440	419	786	1205	1.22
370	441	420	785	1205	1.20
375	442	421	784	1205	1.19
380	443	422	793	1215	1.18
385	445	424	781	1205	1.16
390	446	425	780	1205	1.14
395	447	427	778	1205	1.13
400	448	428	777	1205	1.12
450	460	439	766	1205	1.00
500	470	453	751	1204	0.89
550	479	464	740	1204	0.82
600	489	475	728	1203	0.74

Table 1A - Properties of Saturated Steam (Metric)

Absolute Pressure kPa	Temp. °C	Heat in kJ/kg			Specific Volume cu m per kg	Absolute Pressure kPa	Temp. °C	Heat in kJ/kg			Specific Volume cu m per kg
		Sensible	Latent	Total				Sensible	Latent	Total	
5	33	138	2424	2562	28.192	520	153	644	2105	2749	0.365
20	60	251	2358	2610	4.649	540	155	650	2101	2750	0.353
30	69	289	2336	2625	5.229	560	156	656	2096	2752	0.339
40	76	318	2319	2304	3.993	580	157	662	2092	2753	0.330
50	81	340	2305	2294	3.240	600	158	667	2088	2755	0.320
60	86	360	2294	2653	2.732	650	161	681	2078	2759	0.296
70	90	377	2283	2660	2.365	700	164	695	2067	2762	0.275
80	94	392	2274	2666	2.087	750	167	706	2058	2764	0.259
90	97	405	2266	2671	1.869	800	170	718	2049	2767	0.243
100	100	417	2258	2675	1.694	850	172	729	2041	2769	0.230
101.3	100	419	2257	2676	1.673	900	175	739	2032	2772	0.217
110	102	427	2252	2679	1.562	950	177	749	2024	2774	0.206
120	105	438	2246	2683	1.438	1000	179	759	2017	2776	0.196
130	107	447	2239	2686	1.333	1050	181	768	2009	2777	0.187
140	109	480	2233	2713	1.245	1100	183	777	2002	2779	0.179
150	111	455	2228	2682	1.169	1150	185	786	1994	2780	0.172
160	113	474	2222	2696	1.103	1200	187	795	1987	2782	0.165
170	115	481	2217	2698	1.056	1250	189	803	1981	2783	0.159
180	116	488	2212	2701	0.992	1300	191	811	1974	2785	0.152
190	118	495	2208	2703	0.945	1350	192	819	1968	2786	0.147
200	120	503	2203	2706	0.895	1400	194	826	1961	2787	0.142
210	121	509	2199	2708	0.857	1500	197	841	1948	2789	0.133
220	123	515	2195	2710	0.823	1600	200	855	1937	2791	0.125
230	124	521	2191	2712	0.784	1700	203	868	1925	2793	0.118
240	126	527	2187	2714	0.757	1800	206	880	1914	2795	0.111
250	127	533	2183	2715	0.731	1900	209	893	1903	2795	0.105
260	128	538	2179	2717	0.701	2000	211	904	1893	2797	0.100
270	129	544	2176	2719	0.679	2100	214	915	1882	2798	0.0955
280	131	549	2172	2721	0.653	2200	216	926	1872	2799	0.0912
290	132	554	2169	2722	0.635	2300	219	937	1863	2800	0.0872
300	133	559	2165	2724	0.612	2400	221	947	1853	2800	0.0836
320	135	568	2159	2727	0.576	2500	223	957	1844	2801	0.0802
340	137	577	2152	2730	0.545	2600	225	967	1834	2801	0.0771
360	139	586	2146	2732	0.517	2700	227	976	1825	2801	0.0743
380	141	594	2140	2735	0.492	2800	229	986	1816	2802	0.0716
400	143	602	2135	2737	0.467	2900	231	995	1808	2802	0.0689
420	145	609	2130	2739	0.448	3000	233	1004	1799	2802	0.0666
440	146	617	2124	2741	0.428	3500	241	1045	1758	2802	0.0568
460	148	624	2119	2743	0.410	4000	249	1082	1719	2801	0.0495
480	150	630	2114	2745	0.395	4200	252	1096	1704	2800	0.0470
500	151	637	2109	2747	0.378	4400	255	1110	1689	2799	0.0447

Reference Tables and Formulas (continued)

Table 2 – Weights and Specific Heats of Liquids at 60°F

Liquid	Weight lbs./Gal.	Specific Heat BTU per lb. per °F
Fuel Oil (No. 6)	7.909 to 8.448	0.4 to 0.5
Heat Transfer Oil (Light)	8.17	0.82
Mineral Oil	7.67	0.65
Olive Oil	7.67	0.47
Petroleum Oil	6.84	0.50
Water	8.337	1.00

Steam Flow Requirements for Heating Water

Table 3 – Lbs. of Steam Per Hr. to Heat Water

Temp. Rise(°F)	Gallons of Water Heated Per Hour																			
	25	50	75	100	150	200	300	400	500	750	1000	1500	2000	3000	4000	5000	7500	10000	15000	20000
	Lbs. of Steam Per Hour																			
10	2	4	6	9	13	17	25	33	42	63	83	125	170	250	330	420	630	830	1250	1700
20	4	8	12	17	25	34	50	68	83	125	166	250	340	500	700	830	1250	1700	2500	3400
30	6	12	19	25	37	50	70	100	120	190	250	370	500	700	1000	1200	1900	2500	3700	5000
40	9	17	25	34	50	68	100	135	165	250	335	500	700	1000	1350	1650	2500	3350	5000	7000
50	11	21	31	42	63	84	125	170	210	310	420	630	840	1250	1680	2100	3100	4200	6300	8400
60	13	25	37	50	75	100	150	200	250	375	500	750	1000	1500	2000	2500	3750	5000	7500	10000
80	17	33	50	67	100	135	200	270	330	500	670	1000	1400	2000	2700	3300	5000	6700	10000	14000
100	21	42	63	83	125	166	250	330	420	630	830	1300	1700	2500	3300	4200	6300	8300	13000	17000
120	25	50	75	100	150	200	300	400	500	750	1000	1500	2000	3000	4000	5000	7500	10000	15000	20000
140	29	58	88	116	175	235	350	470	580	880	1160	1800	2400	3500	4700	5800	8800	11600	18000	24000
160	33	68	100	135	200	270	400	540	660	1000	1350	2000	2800	4000	5400	6600	10000	13500	20000	28000

Table 3A – Kg of Steam Per Hr. to Heat Water

Temp. Rise(°C)	Liters of Water Heated Per Hour																			
	95	189	284	379	568	757	1136	1514	1893	2839	3785	5678	7570	11355	15140	18925	28388	37850	56775	75700
	Kg of Steam Per Hour																			
5.6	1	2	3	4	6	8	11	15	19	29	38	57	77	113	150	191	286	376	567	771
11.1	2	4	5	8	11	15	23	31	38	57	75	113	154	227	318	376	567	771	1134	1542
16.7	3	5	9	11	17	23	32	45	54	86	113	168	227	318	454	544	862	1134	1678	2268
22.2	4	8	11	15	23	31	45	61	75	113	152	227	318	454	612	748	1134	1520	2268	3175
27.8	5	10	14	19	29	38	57	77	95	141	191	286	381	567	762	953	1406	1905	2858	3810
33.3	6	11	17	23	34	45	68	91	113	170	227	340	454	680	907	1134	1701	2268	3402	4536
44.4	8	15	23	30	45	61	91	122	150	227	304	454	635	907	1225	1497	2268	3039	4536	6350
55.6	10	19	29	38	57	75	113	150	191	286	376	590	771	1134	1497	1905	2858	3765	5897	7711
66.6	11	23	34	45	68	91	136	181	227	340	454	680	907	1361	1814	2268	3402	4536	6804	9072
77.8	13	26	40	53	79	107	159	213	263	399	526	816	1089	1588	2132	2631	3992	5262	8165	10886
88.9	15	31	45	61	91	122	181	245	299	454	612	907	1270	1814	2449	2994	4536	6124	9072	12701

Table 4 – Physical Properties of Liquid and Gases

	sp gr	sp ht Btu/lb- F
Butanol	0.885	0.654
Dowtherm G	1.130	0.351
Dowtherm HT	1.020	0.320
Dowtherm J	0.891	0.410
Dowtherm LF	1.314	0.361
Dowtherm SR-1	1.151	0.536
Ethanol	0.813	0.547
Ethyl Glycol	1.125	0.602
Freon 11	1.576	0.206
Freon 113	1.659	0.200
Freon 114	1.582	0.211
Freon 12	1.450	0.212
Freon 21	1.464	0.253
Freon 22	1.352	0.271
I-Pentene	0.672	0.494
I-Propanol	0.858	0.446
Isobutanol	0.825	0.497
Methanol	0.844	0.558
n-Heptane	0.715	0.493
n-Hexane	0.682	0.507
No.1 Fuel Oil	0.921	0.404
No.2 Fuel Oil	0.842	0.423
No.3 Fuel Oil	0.874	0.415
No.5A Fuel Oil	0.932	0.402
No.5B Fuel Oil	0.958	0.396
No.6 Fuel Oil	0.980	0.392
n-Octane	0.731	0.495
n-Pentane	0.668	0.517
Propanol	0.852	0.651
Quench Oil	0.922	0.404
SAE 10	0.898	0.409
SAE 20	0.913	0.406
SAE 30	0.918	0.405
SAE 40	0.922	0.404
SAE 50	0.925	0.403
SAE 60	0.932	0.402
SAE 70	0.937	0.401
Sea Water	1.032	0.943
Steam	1.006	1.014
Therminal-44	0.952	0.443
Therminal-55	0.907	0.431
Therminal-60	1.027	0.367
Therminal-66	1.033	0.347
Therminal-75	1.138	0.348
Toluene	0.861	0.397
Trichlorethylene	1.646	0.222
Water	0.995	1.003

General Usage Formulas:

Heating water with steam	$\text{Lbs./hr. Condensate} = \frac{\text{GPM}}{2} \times \text{Temperature Rise } ^\circ\text{F}$
Heating fuel oil with steam	$\text{Lbs./hr. Condensate} = \frac{\text{GPM}}{4} \times \text{Temperature Rise } ^\circ\text{F}$
Heating air with steam coils	$\text{Lbs./hr. Condensate} = \frac{\text{CFM}}{900} \times \text{Temperature Rise } ^\circ\text{F}$
Radiation conversion	$\text{Lbs./hr. Condensate} = \frac{\text{sq. ft. EDR}}{4}$
Heating liquids other than water with steam	$\text{Lbs./hr. Condensate} = \frac{(\text{R}) \times (\text{W}) \times (\Delta\text{T}) \times (\text{H})}{1,000}$ <p>where:</p> <p>(R) = Rate of flow of fluid to be heated (gal./hr.) (W) = Weight of fluid (lbs./hr.) (ΔT) = Fluid temperature rise °F (H) = Specific heat of fluid being heated (BTU/lb.°F)</p>
Cv (valve coefficient) for steam, when: P ₁ = Inlet pressure in psia P ₂ = Outlet pressure in psia P = Pressure drop (P ₁ - P ₂)	When P ₂ ≤ 0.58 P ₁ : $C_v = \frac{\text{lbs./hr.}}{1.71 \times P_1}$ When P ₂ > 0.58 P ₁ : $C_v = \frac{\text{lbs./hr.}}{2.1\sqrt{\Delta P \times (P_1 + P_2)}}$
Cv (valve coefficient) for liquid	$C_v = \frac{\text{GPM} \sqrt{\text{specific gravity}}}{\sqrt{\text{Pressure drop}}}$
Steam Velocity	$V = 2.4 \times \frac{\text{Steam flow (lbs./hr.)} \times \text{specific volume (ft}^3\text{/lbs.)}}{\text{Area of pipe (in.)}}$

Conversion Factors:

Multiply	By	To Get
Boiler hp	33,475	BTU/hr.
Boiler hp	34.5	Lbs./hr/ steam at 0 psig
Boiler hp	140	Sq. ft. EDR
1000 sq. ft EDR	0.5	GPM condensate
EDR (sq. ft.)	0.25	Lbs./hr. condensate
EDR (sq. ft.)	240	BTU/hr. for 2 psig steam filling radiator with 70°F air surrounding radiator
lbs./hr.	960	BTU/hr.
lbs./in. ²	2.307	Feet water column (cold)
lbs./in. ²	2.41	Feet water column (hot)
lbs./in. ²	2.036	in. Hg
lbs./in. ²	0.069	bar
lbs. steam / hr.	0.454	kg. steam / hr.

Steam Traps

Selecting and Sizing Steam Traps

Selecting the proper steam trap is important in effective operation of steam systems. Steam traps are automatic valves that open to pass condensate and close to prevent the flow of steam. The functions of a steam trap in a steam system are to:

- Vent air from the system so steam can enter
- Hold steam in the system until the steam latent heat is removed
- Drain condensate from the system as it is formed after the latent heat is removed.

Removing condensate from piping helps prevent erosion and water hammer. Removing condensate from heat exchangers is required to make room for new steam for the heating process.

There are many types of steam traps. The [Steam Trap Selection Guide Chart](#) points out system conditions that may be encountered and suggests the trap type(s) that may best handle the requirement. Several types of traps may be used for a specific application.

Factors to consider in selecting the type of trap include:

- Constant or modulating condensate load
- Constant or fluctuating pressure
- Speed of air venting required
- Trap location

TRAP SIZING

1. Determine the maximum condensate load (capacity) requirement for the trap by one of the following:
 - Referring to the manufacturers' specifications for the system equipment.
 - Approximating condensate loads using the "General Usage Formulas".
 - Using the "CalcLoad" Load Calculator available through "Steam Specialty Component Selector" on the Hoffman Specialty website or ESP-Plus.
2. Determine the available steam inlet pressure at the trap (This pressure could be different than supply pressure at boiler.)
3. Determine the outlet pressure (backpressure) at the trap discharge. (Pressure against the outlet can be due to static pressure in return line or due to lifting to an overhead return).
4. Determine the pressure differential across the trap. (inlet pressure - outlet pressure = differential pressure).

5. Determine a Safety Factor. The Safety factor will depend on accuracy in determining condensate load, inlet and outlet pressures. Recommendations:

- Float & Thermostatic Trap 1.5 to 2.5
- Bucket Trap 2 to 4
- Thermostatic Trap 2 to 4
- Thermodisc Trap 1 to 1.2

6. Multiply normal maximum condensate load (as determined above) by Safety Factor.
7. Use the Capacity Tables for the selected type of trap to determine the trap model number.
8. Use Ordering Information Charts to determine the part number.

Guidelines:

- The trap seat rating must always be higher than the maximum inlet pressure at the trap.
- When a modulating control valve controls the inlet to equipment, select a trap size with a pressure rating greater than the maximum inlet pressure at the trap.
- Trap capacity should be checked at the minimum differential pressure to assure complete condensate removal under all possible conditions.

Inverted Bucket Trap Operating Pressure Selection:

- Bucket traps are offered with various orifice sizes that determine the maximum operating pressure rating.
- A trap with a lower seat pressure rating has a larger sized orifice than a trap with a higher seat pressure rating. The larger orifice provides a larger condensate rating. When the actual operating pressure is higher than the seat rating, the pressure differential across the seat will prevent the trap from opening. Thus, an inverted bucket trap must be selected for the maximum differential pressure that will be encountered by the trap.
- Trap Capacity Tables show trap capacities at lower differential pressures than the trap rating. This allows selection of a trap at various operating points. A trap with a higher seat pressure rating may be used at lower pressure differentials. However, the capacity rating at that pressure differential will be less than the same size trap with a lower seat pressure rating.

Steam Traps (continued)

Selecting and Sizing Steam Traps (continued)

Lifting Condensate to Overhead Return

Condensate must be lifted in applications where the trap is installed below the return line.

Guidelines:

- Steam pressure at the trap inlet lifts the condensate. Differential steam pressure across the steam trap of 1 psi (0.07 bar) will lift condensate 2 ft. (0.6 m).

- Do not return condensate to an overhead return if modulating control valves are installed. Modulating control valves may cause the inlet pressure to modulate to 0 psi (0 bar). This condition will result in no differential pressure to push the condensate into the overhead return. When this happens, condensate will back up into the steam chamber and result in water hammer. Use a Hoffman condensate unit to collect condensate

Steam Trap Criteria Comparison

CRITERIA	F&T	Inverted Bucket	Thermostatic	Thermodisc
Response to Load Changes	Fast	Moderate	Moderate	Slow
Air Venting	Medium/High	Low	High	Low
Thermal Efficiency	Medium/High	Medium	High	Medium
Primary Applications	Drip Legs Process Equip.	Drip Legs Process Equip.	Drip Legs Process Equip. Tracing	Drip Legs Tracing
Affected by Ambient Temperatures	No (Susceptible to freezing)		No	Yes (unless insulated)
Relative Cost	Medium/High	Medium/Low	Low	Low
Capacity	High	High	Medium	Low
Pressure Range	to 250 psig (17.3 bar)	to 250 psig (17.3 bar)	to 125 psig (8.6 bar)	to 600 psig (41.4 bar)
Size vs. capacity	Large	Large	Small	Medium
Ease of Maintenance	Moderate	Moderate	Very Easy	Very Easy
Orientation limits	Yes	Yes	No	No

Steam Trap Selection Guide Chart

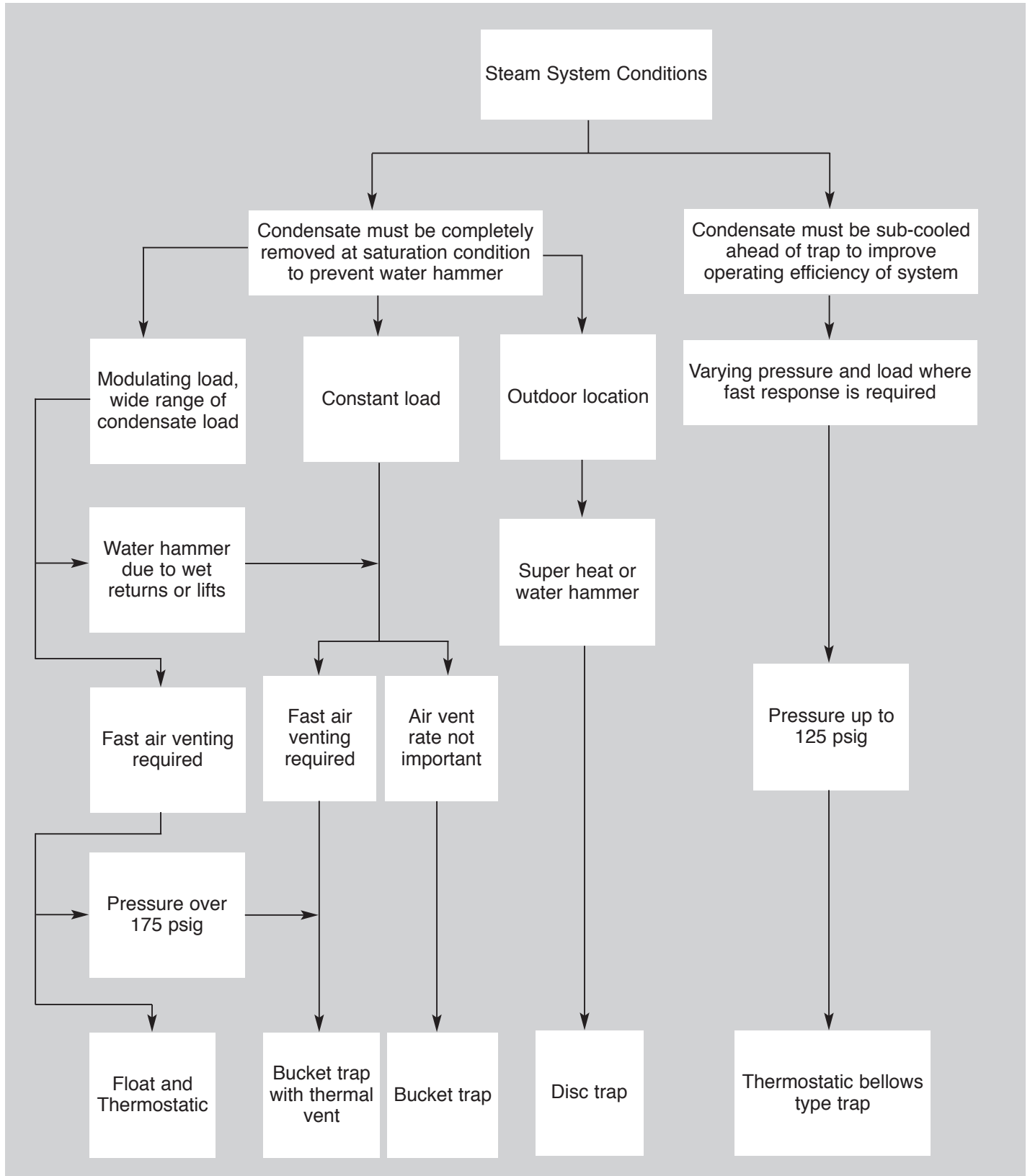

Steam Traps (continued)

Steam Trap Application Guide

This application guide is designed to help in the selection of the type of steam trap for the type of application. The choices are based upon common usage. However, the

specific choice of trap type should be based upon variations in the individual system and personal preference. This chart should serve only as a guide.

APPLICATION	F&T	Inverted Bucket	Thermostatic	Thermodisc
Mains & Tracing Lines				
Steam Mains				
to 30 psig (2.1 bar)	2	3	1	
to 250 psig (17.3 bar)	1	2		3
to 600 psig (41.4 bar)				1
Steam Tracing Lines				
Critical	2	2	2	1
Non-Critical	2	2	1	2
HVAC				
Heat Exchangers				
to 20 psig (1.4 bar)	1	2	2	
to 125 psig (8.6 bar)	1	2	2	
to 250 psig (17.3 bar)	1	2		
Radiators			1	
Unit Heaters	1	2	1	
Air Heating Coils				
to 15 psig (1.0 bar)	1	3	2	
to 60 psig (4.1 bar)	1	2	2	
Absorption chiller	1	2	2	
PROCESS EQUIPMENT				
Process Vats	1			2
Tank Heating				
Storage Tanks	2		1	
Line Heaters	1		2	
Reboiler	1	2		
Rotating Cylinders	1	2		
Evaporators	1	2		
Sterilizer	1		2	
Pressing	1	2	1	
Cooker/Reactor				
to 15 psig (1.0 bar)	1	3	2	
to 60 psig (4.1 bar)	1	2	1	
to 150 psig (10.1 bar)	1	2		

KEY: 1 = First Choice
 2 = Second Choice
 3 = Third Choice
 Blank = Not Recommended

Series 2000

Pressure and/or Temperature Pilot Operated Steam Regulators

Series 2000 Pilot-Operated Regulators consist of a main valve that is controlled by a single or combination of pilot control valves.

There are a number of types of pilot control valves available:

- Series SPS Spring Pressure Control Pilots – for self-contained pressure regulation
- Series STPA Self-Contained Temperature Control Pilots – for control of heated fluids
- Series AP Air Pressure Control Pilots – for remote pressure control using air pressure
- Series 315 PNT and Series 240 PNT Pneumatic Temperature Control Pilots – for rapidly changing load requirement applications

Different types of pilot valves can be used in combination to control more than one function or as a safety override. For example, a temperature pilot may be used in conjunction with a spring pressure pilot to control both temperature and pressure. Or, a temperature pilot may be used with a solenoid pilot to provide automatic shutdown when an over-temperature condition occurs.

Operation of Series 2000 Pilot-Operated Regulator Main Valve

The regulator main valve is held closed by the pressure on the diaphragm from an internal main spring. Pilot control valves control steam flow from the upstream supply side of the main valve to the underside of the diaphragm of the main valve. When the pilot valve opens, steam flows through the pilot and pressure builds in the signal line, applying pressure under the main valve diaphragm. This pressure force compresses the main valve spring and the main valve opens.

Under constant steam demand, the pilot and main valve remain relatively motionless. As the system approaches the pilot set point, the pilot valve begins to close. Less steam passes through the pilot and through the signal line. Pressure in the signal line decreases as steam passes through a small bleed orifice on the main valve. With lower steam pressure under the main valve diaphragm, the main valve spring forces the main valve to close.

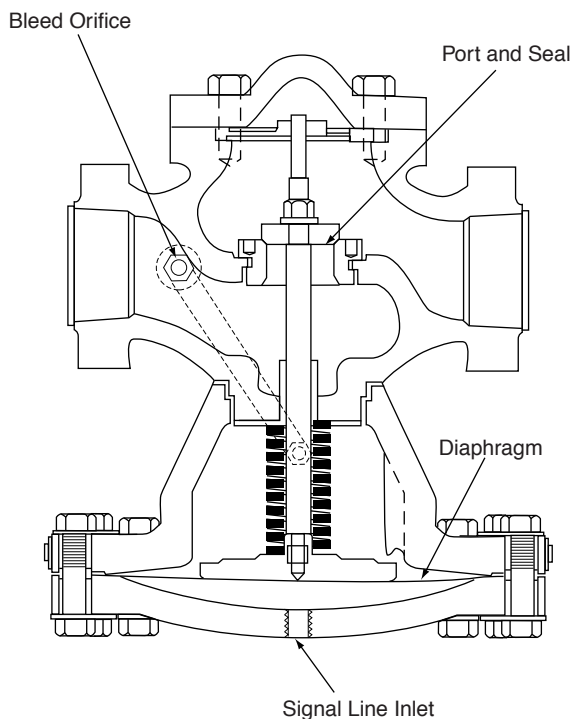

Series 2000

Pressure and/or Temperature Pilot Operated Steam Regulators

Operation - Main Valve with a Spring or Air Pilot

Pressure may be controlled by use of either a spring pilot or an air pilot. The only functional difference is that a spring pilot uses a spring to apply loading force to the pilot diaphragm and the air pilot uses air pressure.

Downstream pressure is sensed and fed back to the pilot through the feedback line to the underside of the pilot diaphragm. The downstream pressure balances against the spring (or air pressure) force in the pilot, causing the pilot valve to move. This movement opens or closes the pilot valve. When the downstream pressure is below the pilot set point, the force from the spring or air opens the pilot valve and inlet steam flows through the pilot. The open pilot valve allows the flow of steam through the pilot seat and signal line, and on to the underside of the main valve diaphragm. The force from the steam pressure pushes against the main valve spring to control the main valve position. The main valve opens or closes in response to its diaphragm movement.

Under constant steam demand, the pilot and main valve remain relatively motionless. As steam demand decreases, the downstream pressure will rise. When the downstream pressure rises, the pilot valve senses the change relative to the spring or air loading force and the pilot begins to close. Less steam flows through the pilot and signal line to the underside of the main valve diaphragm. The steam trapped under the main valve diaphragm bleeds off through an orifice, allowing the main valve to close.

Main Valve with Spring Pilot

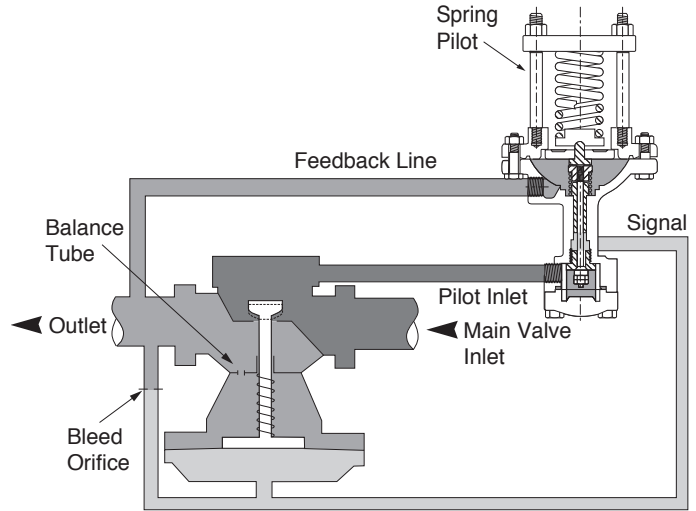

Main Valve with Air Pilot

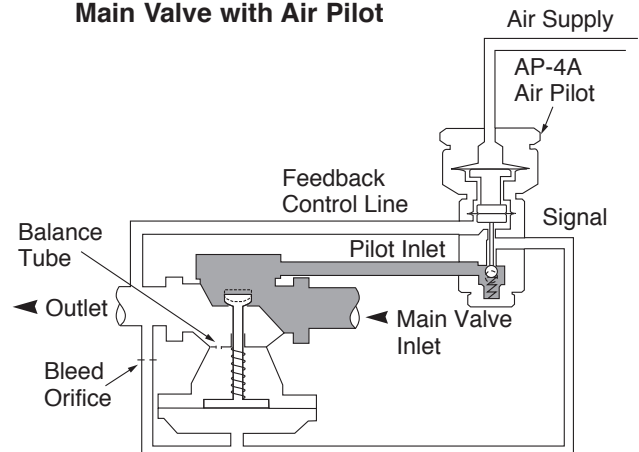

Series 2000

Pressure and/or Temperature Pilot Operated Steam Regulators (continued)

Operation - Main valve with a Self Contained Temperature Pilot

Self-contained temperature control pilots use a liquid-filled bulb and bellows. The actuating force for the pilot results from the volumetric expansion of the liquid as the bulb temperature increases. The expansion or contraction of the liquid controls the position of the pilot seat.

The sensing bulb is completely inserted into a downstream heated fluid to sense the fluid temperature. The sensing bulb is connected to a bellows by a capillary tube. When the bulb temperature is below the set point, a spring in the pilot keeps the pilot valve open and allows steam to flow from the pilot inlet through the signal line, and on to the underside of the main valve diaphragm. The force from the steam pressure pushes against the main valve spring to control the main valve position. The main valve opens or closes in response to its diaphragm movement.

Under constant steam demand, the pilot and main valve remain relatively motionless. As the bulb temperature increases and the liquid expands, the expansion is transmitted through the capillary tube, creating an actuating force on the bellows. The bellows expand to close the pilot valve, shutting down the flow of steam through the pilot seat and signal line to the underside of the main valve diaphragm. The steam trapped under the main valve diaphragm bleeds off through an orifice, allowing the main valve to close.

Temperature Pilot Operation

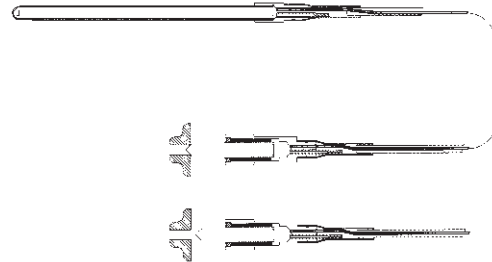

Main Valve with Temperature Pilot

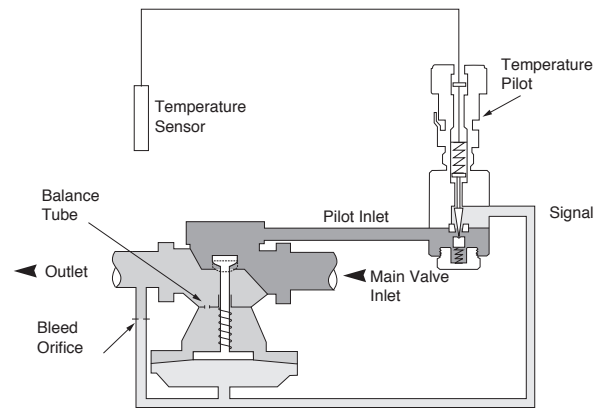

Operation - Main Valve with a Combination of Pilots

When a temperature pilot is installed in series with a pressure pilot, the pilots perform their functions separately and concurrently. Each pilot regulation cycle is exactly the same as if used alone. When both pilots are open, the main valve will open, if either pilot closes, the main valve will close. The pressure pilot essentially acts to limit the maximum pressure as the temperature pilot cycles to control temperature.

Main Valve with Temperature and Pressure Pilot

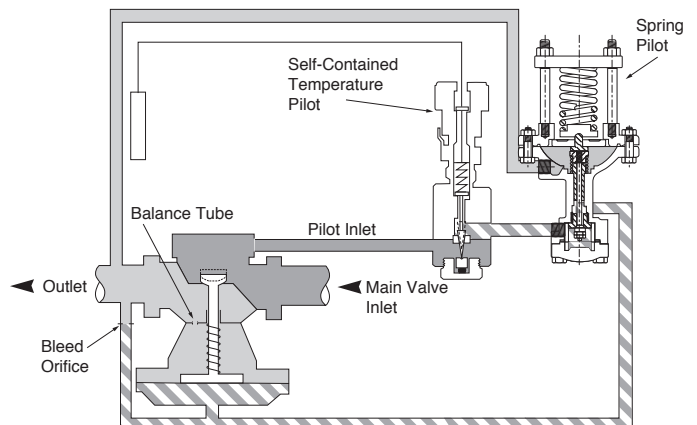

Series 2000 (continued)

Operation - Main Valves with Pneumatic Temperature Pilots

The air pilot and pneumatic temperature pilot combination is used to control temperature in systems with rapid changes in the required heat load. An air PRV is used to limit the pressure of air supplied to the pneumatic temperature pilot. Limiting this supply pressure limits the air pilot loading force and hence the main valve downstream pressure.

When the pneumatic temperature pilot senses a temperature below the set point, it delivers an air signal to the air pilot based on the sensed temperature. This air signal becomes the air pilot loading force. If the pressure downstream from the main valve is below the air pilot loading force, the pilot valve diaphragm pressure is no longer balanced. The pilot valve opens and inlet steam is passed through the air pilot to the signal line. Steam flowing through applies pressure on the lower side of the main valve diaphragm. This force from the steam compresses the main valve spring and the main valve opens.

Under constant steam demand, the pilot and main valve remain relatively motionless. As temperature rises to the pneumatic temperature pilot set point, the temperature pilot lowers the loading force to the air pilot. When the loading force decreases below the force produced by the downstream pressure, the air pilot begins to close. Less steam flows through the air pilot and signal line to the underside of the main valve diaphragm. The steam trapped under the main valve diaphragm bleeds off through an orifice, allowing the main valve to close.

Operation with the GT610-IP Electro-Pneumatic Transducer is similar with the exception that the sensed temperature is represented by an electronic signal which the transducer converts to a pneumatic control signal for the air pilot.

These arrangements give rapid response for heat load changes and it also limits main valve downstream pressure.

Main Valve with Pneumatic Temperature Pilot and Air Pilot

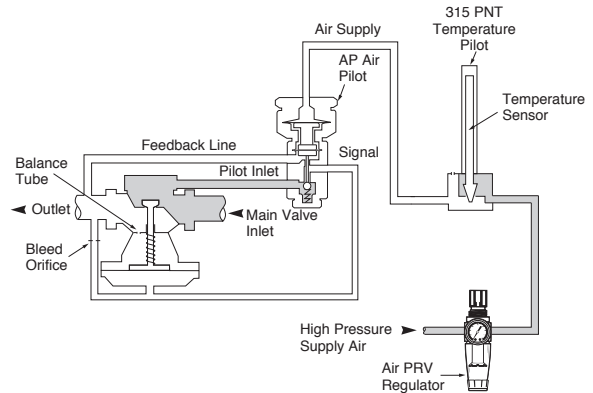

Main Valve with Electro-Pneumatic Transducer and Air Pilot

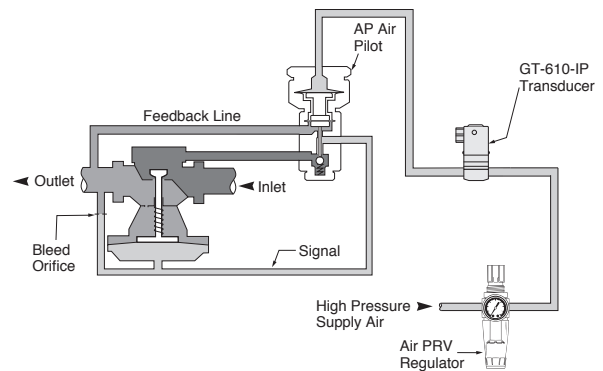

Series 2000

Pressure and/or Temperature Pilot Operated Steam Regulators (continued)

Accuracy of Control—Regulator Steam Capacities

Hoffman Specialty Series 2000 Regulator capacities, shown in the flow capacity charts on pages 45 - 48 in the Series 2000 Ordering Information section, are based on test data. The chart data indicates flow capacity values derived from plots of test data that show the drop away (droop) from the set pressure as shown in the graph below. The rated flow capacity (A) is where the curve passes a pressure droop of

10% of set pressure below the set pressure (B) [i.e., 75 psi x 0.1 = 7.5 psi (5.2 bar x 0.1 = .52 bar) below the set pressure of 75 psig (5.2 bar)]. The curves in the graph below demonstrate how the reduction in trim size affects performance. As a general rule it is best to use the smallest valve and trim possible that provides adequate flow capacity.

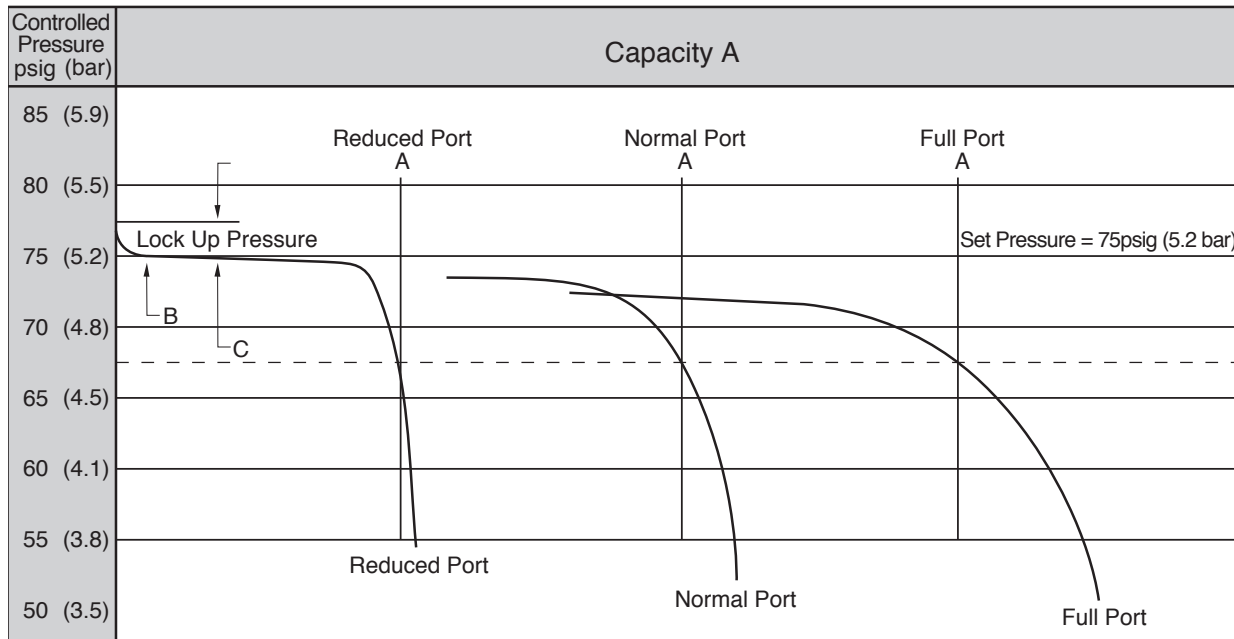

Capacity units are not shown. Curves are typical for all Main Valve sizes.

- A. Flow at which port will be rated 10% droop [i.e. 75 psig x .1 = 7.5 psig (5.2 bar x .1 = .52)] from set pressure.
- B. Minimum controllable flow.
- C. Pressure rise above set pressure upon closing.

Capacity vs Controlled Pressure for Typical Main Valve with Spring Pilot

Regulator saturated steam capacities are tabulated in charts on pages near the Series 2000 Regulator Ordering Information. Note that all valves are available in several trim sizes to allow flexible selections. These capacities have been determined as outlined in PTC 19.5; 4-1959 “Chapter 4 Flow Measurement, ASME Power test Code.” The capacities conform to Fluid Controls Institute, Inc. specification FCI-58-1, “Definitions of Regulator Capacities.” The capacities are based on a 10% accuracy of regulation [2 psig (.14 bar) minimum] with the set point at minimum controllable flow, defined as 2% of maximum flow. Capacities are the same for whichever pilot is utilized.

When using the capacity tables remember:

- Values shown are maximum flow with minimum piping restriction.
- Maximum single stage reduction 150 psi (10.3 bar) (100 psi (6.9 bar) recommended).
- Values are for saturated steam; superheated steam requires a correction factor.
- Outlet pressures lower than the lowest shown will have a capacity equal to the lowest shown.
- All valves have 3 capacity ports available.
- Multi-stage reductions will have a flow capacity equal to the lower flow capacity of the two.

Series 2000

Pressure and/or Temperature Pilot Operated Steam Regulators (continued)

How To Size Series 2000 Main Valves

Selecting the proper Series 2000 Pilot-Operated Regulator provides accuracy and efficiency in the control and operation of steam systems and their components. Series 2000 Regulator main valves are controlled by pilot valves. Pilot valves of different types can be used individually or in combination to:

- Control downstream steam pressure
- Control process temperature
- Control both downstream pressure and process temperatures in system components
- Provide a safety override.

A complete Series 2000 Regulator consists of:

- Main valve
- Control pilot or combination of pilots
- Hardware kit

Main Valve Sizing

1. Determine the available steam inlet pressure.
2. Determine the reduced steam outlet pressure.
3. Determine the capacity required by referring to the manufacturer's specifications for your equipment.
4. Apply the specifications (as determined in steps 1-3) to the Full Port Steam Capacity Table to determine the main valve size. If steam inlet pressure is below 30 psig (2.1 bar) use the Low Pressure Steam Capacity Table for Models 2150 or 2250 Main Valves.

Guidelines:

- To prevent seat damage and maintain control and accuracy, do not oversize the main valve. Select a regulator main valve that will operate between 50 - 100% of its capacity rating. If necessary, use Normal or Reduced Port Steam Capacity Tables.
- A Normal or Reduced Port Main Valve is recommended for systems that will expand in the future.
- The maximum recommended pressure drop across a single valve is 100 psig (6.9 bar). Operating with more than a 100 psig (6.9 bar) pressure drop may cause wire draw in the seat and excessive noise.

- Although not recommended, a Series 2000 Main Valve may be used for pressure drops up to 150 psi (10.4 bar).
- Main Valve noise data is available through "Steam Specialty Component Selectors" on the Hoffman Specialty website, ESP-Plus or upon request.
- To prevent excessive relief valve popping, the relief valve set point pressure must be capable of being set as follows:

Downstream system pressure at no load pressure	Relief valve set point pressure = downstream pressure plus
≤ 35 psig	5 psig
> 36 psig	10 psig

5. Use the Main Valve Body Style Chart to select a model number (based on size and pressure).
6. Use the Ordering Information Chart to determine the part number (based on the model number).
7. Size inlet and outlet piping for velocity:
 For heating or indoor applications –
 4,000-6,000 ft./min. (1,219-1,828 m/min.)
 For industrial or outdoor applications –
 8,000-12,000 ft./min. (2,438-3,657 m/min.)

 Note: Main valve noise data available through ESP-Plus, or upon request.
8. Install drip traps ahead of regulators to drain condensate from steam lines.

Series 2000

Pressure and/or Temperature Pilot Operated Steam Regulators (continued)

Sizing Examples

Example 1.

Conditions:

In this example, the steam supply to the process equipment in the installation (system) will be regulated by one Series 2000 pressure regulator. Assume all equipment will be operating at the same time at a constant load.

Problem:

Calculate the steam load requirements for all of the equipment in the process system by referring to the equipment name plate. Then select a Series 2000 pressure regulator from the Steam Capacity Tables to determine the specific model pressure regulator and valve size needed.

Known Data

Inlet pressure 75 psi (5.3 bar)

Equipment Identification	Operating Pressure psi (bar)	Maximum Pressure psi (bar)	Equipment Steam Loads Requirements lbs./hr. (kg/hr.)	Pipe Size in.
A	20 (1.4)	40 (2.8)	300 (136)	½
B	20 (1.4)	30 (2.1)	600 (272)	¾
C	20 (1.4)	25 (1.75)	400 (181)	¾
D	20 (1.4)	25 (1.75)	800 (363)	1
E	20 (1.4)	25 (1.75)	500 (227)	½
F	20 (1.4)	50 (2.5)	600 (272)	¾
Total Capacity 3200 lbs./hr. (1453 kg/hr.)				

Procedure:

For this problem assume :

1. An inlet pressure of 75 psi (5.2 bar).
2. An outlet pressure of 20 psi (1.4 bar).
3. The steam load adds up to 3200 lbs./hr. (1453 kg/hr.) as shown to the left.

Example 2.

Conditions:

In this example, a pressure/temperature regulator has to be selected to regulate the steam going into a steam to water heat exchanger. Due to a planned plant addition in the next 5 years, the steam system will be enlarged.

Problem:

The exchanger heats water from 50°F to 150°F (10-65°C) and has an assumed water flow of 50 gpm (189 lpm). The heat exchanger is limited to a 20 psi (1.4 bar) steam pressure. Assume the steam supply pressure is 100 psi (6.9 bar).

Procedure (continued):

4. Be sure to review the recommendations for good practice in selecting pressure regulators.
5. Refer to the Full Port Capacity Table page 45 first for the selection. The normal and reduced trim capacity tables should be used if there is a possibility the system will be expanded in the future.
6. Select the smallest regulator possible that will handle the steam load requirements. Typically it can be found in the Full Port Capacity Table.
7. When the outlet steam pressure is 50% or less of the inlet pressure, use the lowest outlet pressure shown in the capacity table.

Answer:

1. Referring to the Full Port Capacity Table, with the conditions given above under procedure, the correct valve to select would be a Model 2100 1½" Main Valve-Full Port.
2. Since in this example there is no supply of compressed air in the plant nor a need to also control temperature, a spring pilot would be selected to handle the outlet pressure requirements. This would be a Model SPS-30 with an adjustable range of 2 to 30 psi (.14 to 2.0 bar). Adjust the pilot to 20 psi (1.4 bar). A model SPS-60 pilot with an adjustable range of 5 to 60 psi (0.3 to 4.1 bar) could also be used.

Known Data:

Temperature Rise — 150°F - 50°F = 100°F (66 - 10 = 56°C)
 Water Flow — 50 gpm (189 lpm) = 3000 gph (11,356 lph)
 Steam Inlet — 100 psi (6.9 bar)
 Steam Outlet — 20 psi (1.4 bar) (heat exchanger limit)

Procedure:

1. Refer to page 104 to obtain the steam required to satisfy the above conditions. This would be 2500 lbs./hr. (1134 kg/hr.) according to the tables.
2. Since it is planned to enlarge this system at a later date, refer to the steam capacity tables for a normal port to obtain the regulator size .

Series 2000

Pressure and/or Temperature Pilot Operated Steam Regulators (continued)

Sizing Examples

Example 2. (continued)

3. When the outlet steam pressure is 50% or less of the inlet pressure, use the lowest outlet pressure shown in the capacity table.

Answer:

1. Using the above data and referring to the Normal Port Capacity Table page 46, a 1¼" NPT main valve with a normal port that passes 2880 lbs./hr. (1306 kg/hr.) of steam would be selected.

The order would be for:

One, Model 2100, 1¼" NPT Main Valve-Normal Port.

2. Since temperature must be controlled, a combination of spring and temperature pilots should be selected. This would be:

One Model SPS-60 with adjustable range of 5 to 60 psi. (0.3 to 4.1 bar) or one Model SPS-30 with adjustable range of 2 to 30 psi (0.1 to 2.0 bar). The pilot would be adjusted to the required 20 psi (1.4 bar).

One Model STPA-200 with a temperature range of 50-200°F (10-93°C) would be selected and adjusted to 150°F (65°C) to maintain the desired temperature of water leaving the heat exchanger.

NOTE: An alternate option is to use a pneumatic temperature pilot with an air pressure pilot and an air regulator. This would be:

One Model 315 PNT with a temperature range of 50-300°F (10-149°C) adjusted to 150°F (65°C) to maintain the desired temperature of water leaving the heat exchanger.

One Model AP-1A Air Pressure pilot to receive the control signal from the pneumatic temperature pilot.

One Air PRV Regulator, adjusted to maintain a maximum 20 psi (1.4 bar) outlet pressure.

Typical Guidelines for Selection of Temperature Regulators

The degree of temperature variation depends on load change. The chart below is based on 0% through 100% load change.

Type of Heater	Application	Type of Regulator
Instantaneous Heater	Domestic Hot Water	Series 2000 with pneumatic pilot for $\pm 4^{\circ}\text{F}$ ($\pm 2.2^{\circ}\text{C}$). (must be used with anti-scald protection)
	Process fluids	Series 2000 with pneumatic pilot for $\pm 4^{\circ}\text{F}$ ($\pm 2.2^{\circ}\text{C}$). Series 2000 with STPA pilot for $\pm 10^{\circ}\text{F}$ ($\pm 5.6^{\circ}\text{C}$). (System recirculation is recommended)
	Wash down stations	Same as process fluids (Pneumatic recommended if available)
	Steam to water converters	Series 2000 with either direct or pneumatic operated pilots. $\pm 10^{\circ}\text{F}$ ($\pm 5.6^{\circ}\text{C}$) accuracy.
Semi-instantaneous Heater or Storage Heater	Domestic hot water	Series 2000 with pneumatic temperature pilot $\pm 4^{\circ}\text{F}$ ($\pm 2.2^{\circ}\text{C}$) accuracy (must be used with anti-scald protection)
	Process fluids	Series 2000 with pneumatic temperature pilot $\pm 4^{\circ}\text{F}$ ($\pm 2.2^{\circ}\text{C}$) accuracy. Direct-operated pilots $\pm 10^{\circ}\text{F}$ ($\pm 5.6^{\circ}\text{C}$) accuracy.
	Wash down stations	Same as process fluids

Series 2000

Pressure and/or Temperature Pilot Operated Steam Regulators (continued)

A complete Series 2000 Regulator consists of:

- Main valve
- Control pilot or combination of pilots
- Hardware kit

There are a number of types of pilot control valves available:

- **Series SPS Spring Pressure Control Pilots** – for self-contained pressure regulation.
- **Series AP Air Pressure Control Pilots** – for remote pressure control using air pressure (requires an air pressure signal).
- **Series STPA Self-Contained Temperature Control Pilots** – for direct control of temperature in heated fluids.
- **Series 315 PNT and Series 240 PNT Pneumatic Temperature Control Pilots** – for rapidly changing load requirement applications (requires an air pressure signal and an AP Air pressure Control Pilot).
- **Series SLD Solenoid Pilots** – for remote control or safety overrides.

Different types of pilot valves can be used in combination to control more than one function or as a safety override. For example, a temperature pilot may be used in conjunction with a spring pressure pilot to control both temperature and pressure. Or, a temperature pilot may be used with a solenoid pilot to provide automatic shutdown when an over-temperature condition occurs.

How to Select Series 2000 Pilots

Series SPS Spring Pressure Control Pilots

– for self-contained pressure regulation.

1. Determine the reduced steam outlet pressure to be maintained downstream of main valve.
2. Use the Spring Pilot Ordering Information Chart to:
 - a) Select a model number (based on the outlet pressure determined above).
 - b) Determine the part number (based on the model number).

Series AP Air Pressure Control Pilots – for remote pressure control using air pressure (Air PRV Regulator is also required)

1. Determine the reduced steam outlet pressure to be maintained downstream of main valve.
2. Determine the air loading pressure available from the Air PRV or Pneumatic Temperature Pilot.
3. Use the Air Loading Data Graph to select a model number that meets the requirements of the outlet steam pressure and available air loading pressure as determined above.
4. Use the Air Pilot Ordering Information Chart to determine the part number (based on the model number).
5. Use the Air PRV Regulator Ordering Information Chart to determine the part number.

Series STPA Self-Contained Temperature Control Pilots – for direct control of temperature in heated fluids.

1. Determine the process temperature of the fluid whose temperature is being controlled.
2. Determine the length of capillary tube required between the main valve and the temperature monitoring point.
3. Use the Self-Contained Temperature Pilot Ordering Information Chart to:
 - (a) Select a model number (based on the temperature range and capillary range as determined above).
 - (b) Determine the part number (based on the model number).
4. (Optional) Use the Well Ordering Information Chart to:
 - (a) Select a model number (based on desired bulb material).
 - (b) Determine the part number (based on the model number).

How to Select Series 2000 Pilots (continued)

Series 315 PNT Pneumatic Temperature Pilot – For Shop Quality Air

1. Determine the process temperature of the fluid whose temperature is being controlled.
2. Determine bulb material compatible with process fluid.
3. Use Model 315 PNT Pneumatic Temperature Pilot Ordering Information to select model (based on temperature range and bulb material as determined above).
4. (Optional) Use the Well Ordering Information Chart to:
 - (a) Select a model number (based on bulb material).
 - (b) Determine the part number (based on the model number).
5. Determine the reduced steam outlet pressure to be maintained downstream of main valve.
6. Determine the air loading pressure available from the Air PRV or Pneumatic Temperature Pilot.
7. Use the Air Loading Data Graph to select a model number that meets the requirements of the outlet steam pressure and available air loading pressure as determined above.
8. Use the Air Pilot Ordering Information Chart to determine the part number (based on the model number).
9. Use the Air PRV Regulator Ordering Information Chart to determine the part number.

Series 240 PNT Pneumatic Temperature Control Pilot – For Control Quality Air

1. Use Model 240 PNT Pneumatic Temperature Pilot Ordering Information to determine part number.
2. Determine the reduced steam outlet pressure to be maintained downstream of main valve.
3. Determine the air loading pressure available from the Air PRV or Pneumatic Temperature Pilot.
4. Use the Air Loading Data Graph to select a model number that meets the requirements of the outlet steam pressure and available air loading pressure as determined above.
5. Use the Air Pilot Ordering Information Chart to determine the part number (based on the model number).
6. Use the Air PRV Regulator Ordering Information Chart to determine the part number.

Electro-Pneumatic Transducer

1. Use the Electro-Pneumatic Transducer Ordering Information Chart to determine the part number.
2. Use the Air Loading Graph to select a model number that meets your desired outlet steam pressure (based on your available air loading pressure).
3. Use the Air PRV Regulator Ordering Information Chart to determine the part number.

Solenoid Pilots for on/off control

1. Determine which operating mode, "Normally Open" or "Normally Closed", is better suited for your application by reading the descriptive information.
2. Use the Ordering Information Chart to:
 - (a) Select a model number (based on the operating mode and the inlet steam pressure operating range).
 - (b) Determine the part number (based on the model number).

Hardware Kits

1. Use the Hardware Kit Ordering Information Chart to:
 - (a) Select a kit (based on the main valve size and the type of pilot(s) used).
 - (b) Determine the part number (based on the kit selected).

Series 2000 Typical Applications

Typical Series 2000 Pressure Pilot Installation

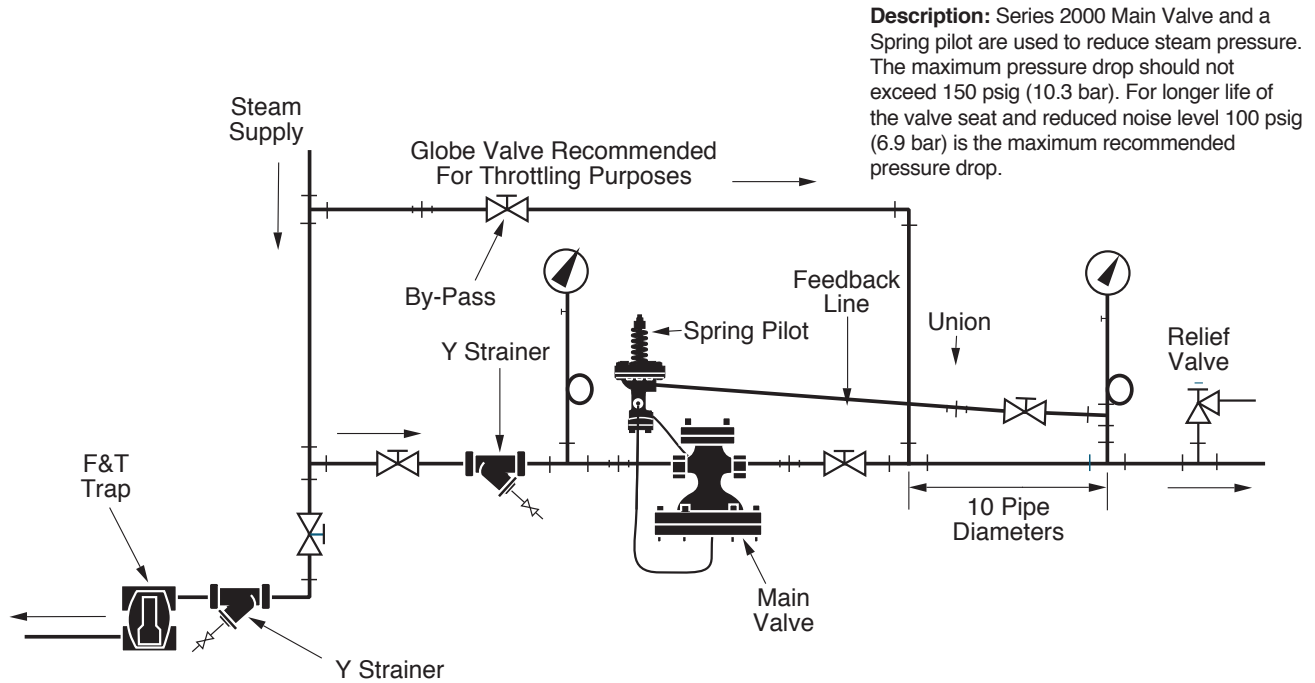

Description: Series 2000 Main Valve and a Spring pilot are used to reduce steam pressure. The maximum pressure drop should not exceed 150 psig (10.3 bar). For longer life of the valve seat and reduced noise level 100 psig (6.9 bar) is the maximum recommended pressure drop.

The relief valve should be sized for maximum capacity. A by-pass line and drip trap are always recommended for

pressure regulator installations. The sensing line should be at least 10 pipe diameters downstream from the gate valve.

Series 2000 Typical Applications (continued)

Typical Series 2000 Combination Pressure-Temperature Pilot to Control Water Heater Exchanger

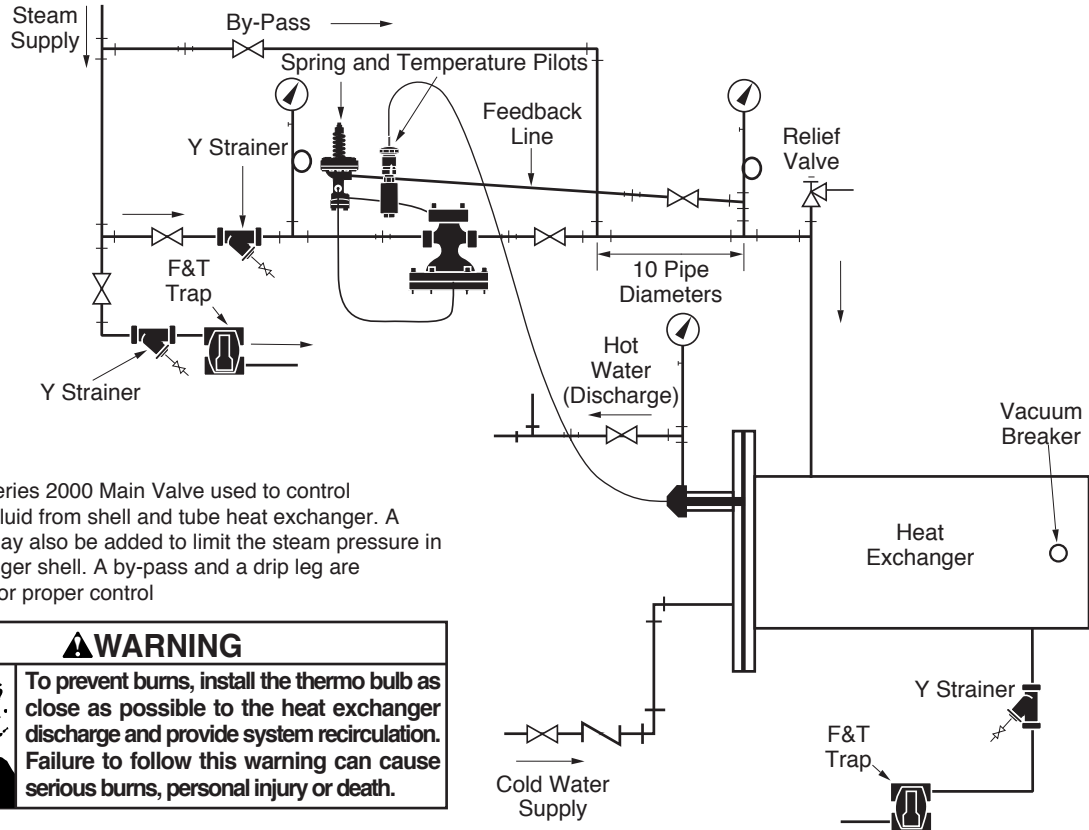

Description: Series 2000 Main Valve used to control temperature of fluid from shell and tube heat exchanger. A pressure pilot may also be added to limit the steam pressure in the heat exchanger shell. A by-pass and a drip leg are recommended for proper control

⚠ WARNING	
	<p>To prevent burns, install the thermo bulb as close as possible to the heat exchanger discharge and provide system recirculation. Failure to follow this warning can cause serious burns, personal injury or death.</p>

Typical Parallel Pressure Regulator Station

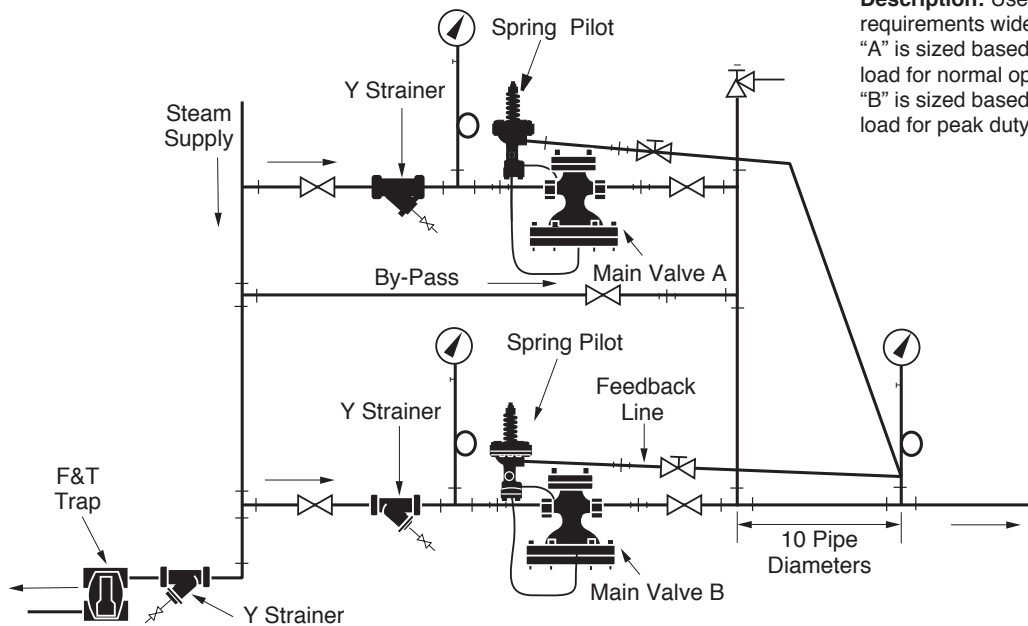

Description: Used when the load requirements widely vary. Main valve "A" is sized based on 1/3 the total load for normal operation. Main valve "B" is sized based on 2/3 the total load for peak duty operation.

Series 2000 Typical Applications (continued)

Pneumatic Temperature Control on Instantaneous Heater

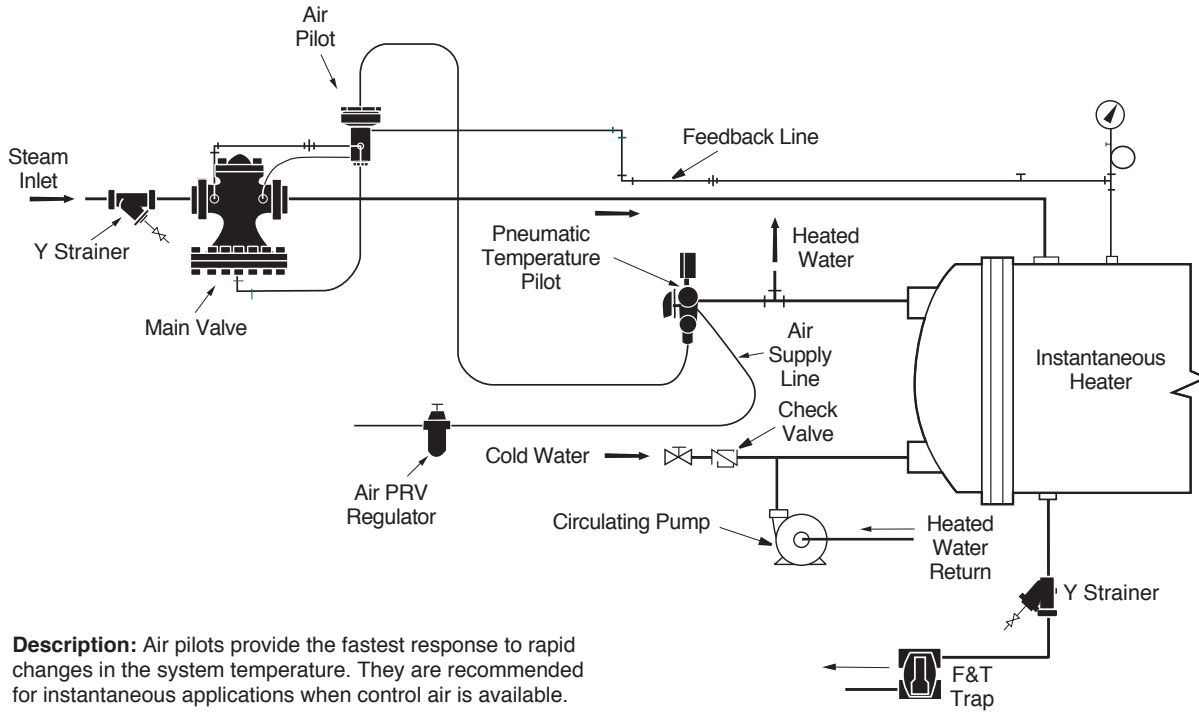

Description: Air pilots provide the fastest response to rapid changes in the system temperature. They are recommended for instantaneous applications when control air is available.

Temperature Regulators Used in Parallel to Control Widely Varying Flow Rates

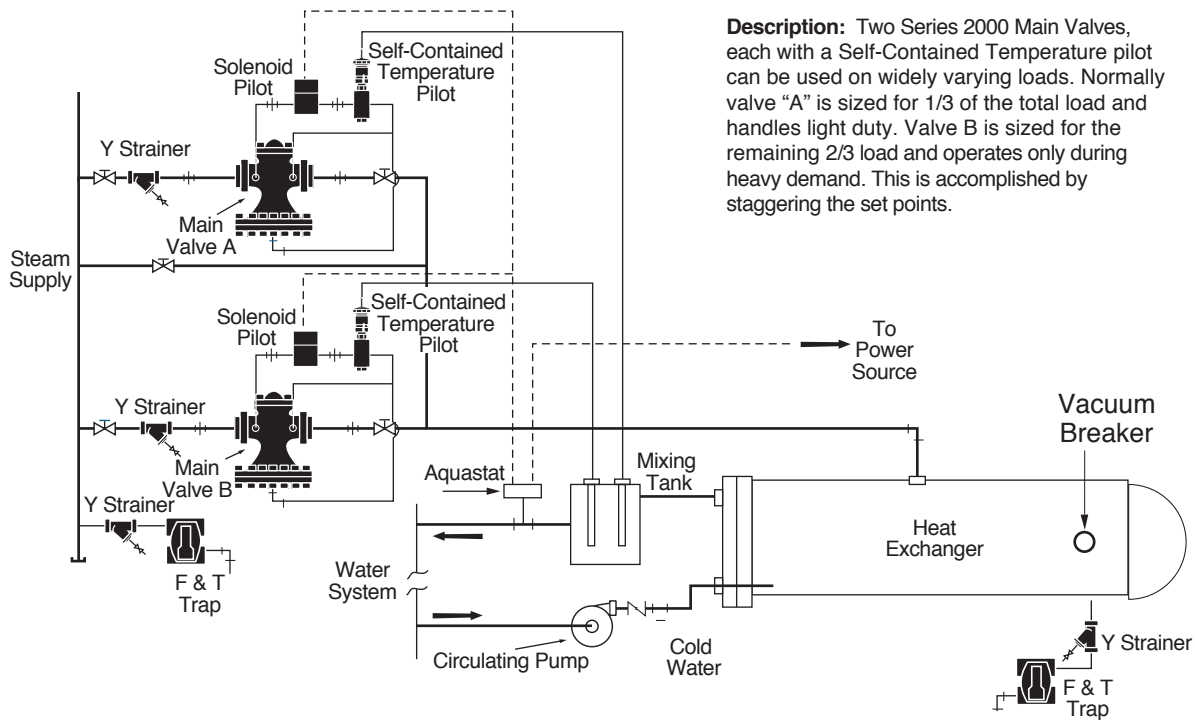

Description: Two Series 2000 Main Valves, each with a Self-Contained Temperature pilot can be used on widely varying loads. Normally valve "A" is sized for 1/3 of the total load and handles light duty. Valve B is sized for the remaining 2/3 load and operates only during heavy demand. This is accomplished by staggering the set points.

Series 2000 Typical Applications (continued)

Automatic Control of Heat Exchanger with High Limit Safety Control

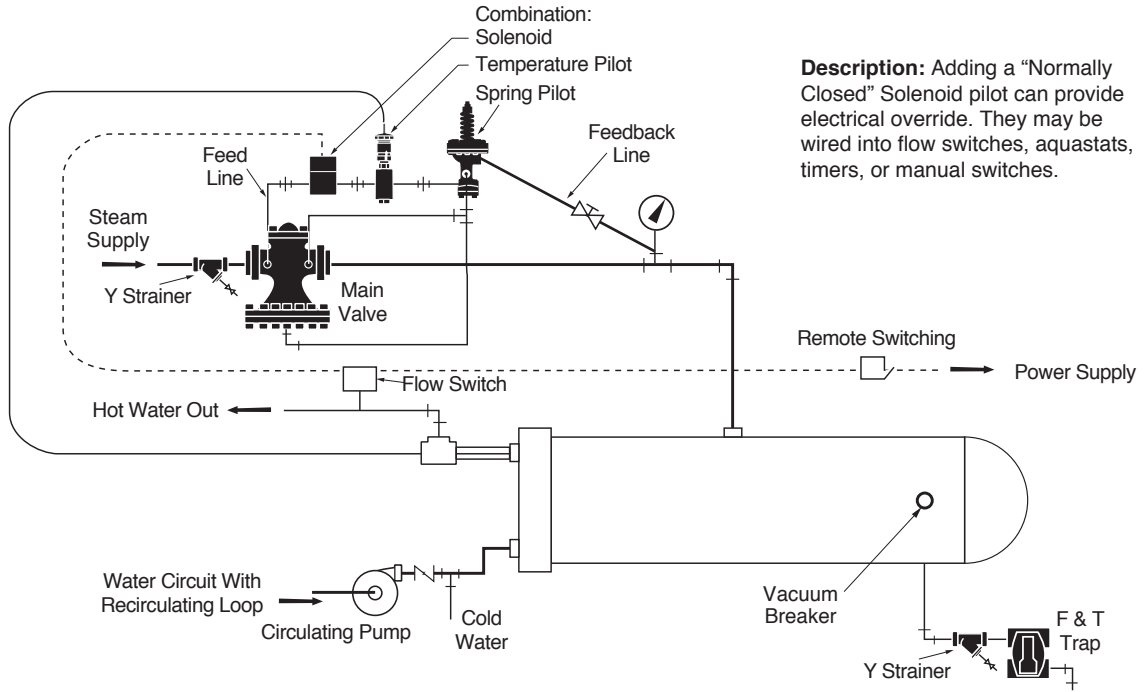

Description: Adding a "Normally Closed" Solenoid pilot can provide electrical override. They may be wired into flow switches, aquastats, timers, or manual switches.

Electronic-Pneumatic Temperature Pilot for Instantaneous Heater Recirculation System

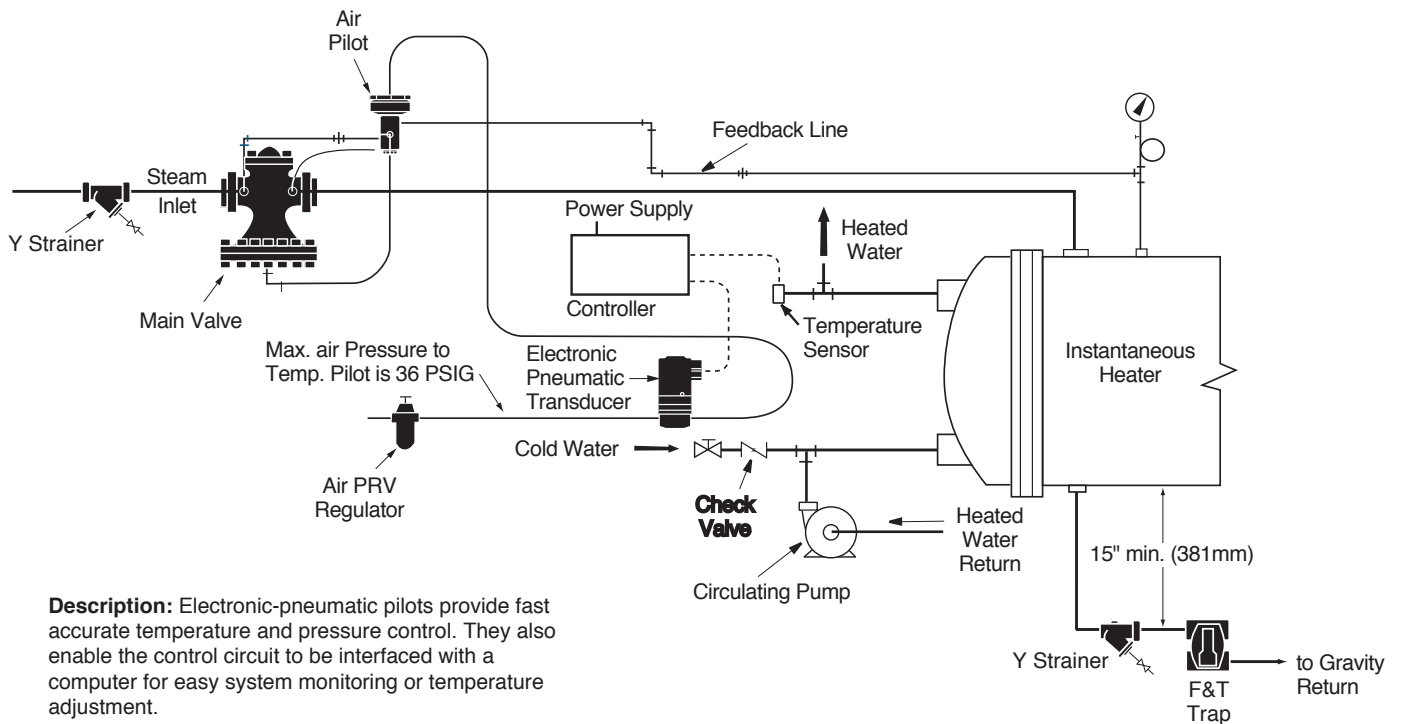

Description: Electronic-pneumatic pilots provide fast accurate temperature and pressure control. They also enable the control circuit to be interfaced with a computer for easy system monitoring or temperature adjustment.

Series 2000 Typical Applications (continued)

Temperature Control for Tank Farm Fuel Oil Storage

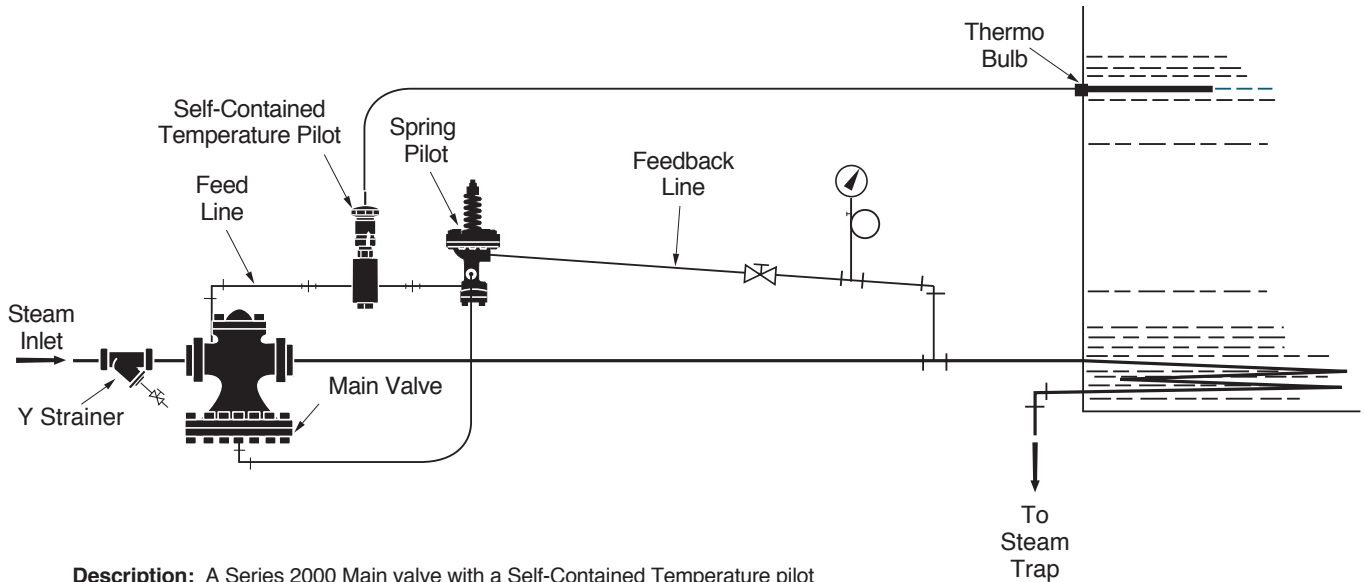

Description: A Series 2000 Main valve with a Self-Contained Temperature pilot and a Spring pressure pilot are used to control the temperature in a oil storage tank.

Pressure and Temperature Control for Unit Heaters

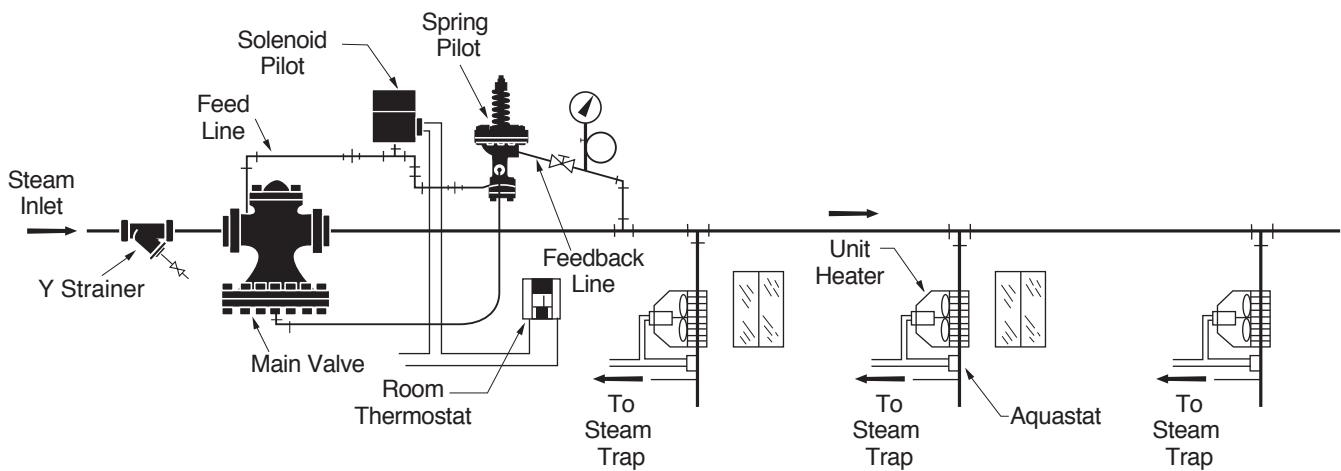

Description: Unit heaters will radiate approximately 7% of their capacity when the fan is off, use of a solenoid pilot controlled by a room thermostat eliminates energy waste when heat is not required.

Series 2000 Typical Applications (continued)

Instantaneous Heater Domestic Hot Water

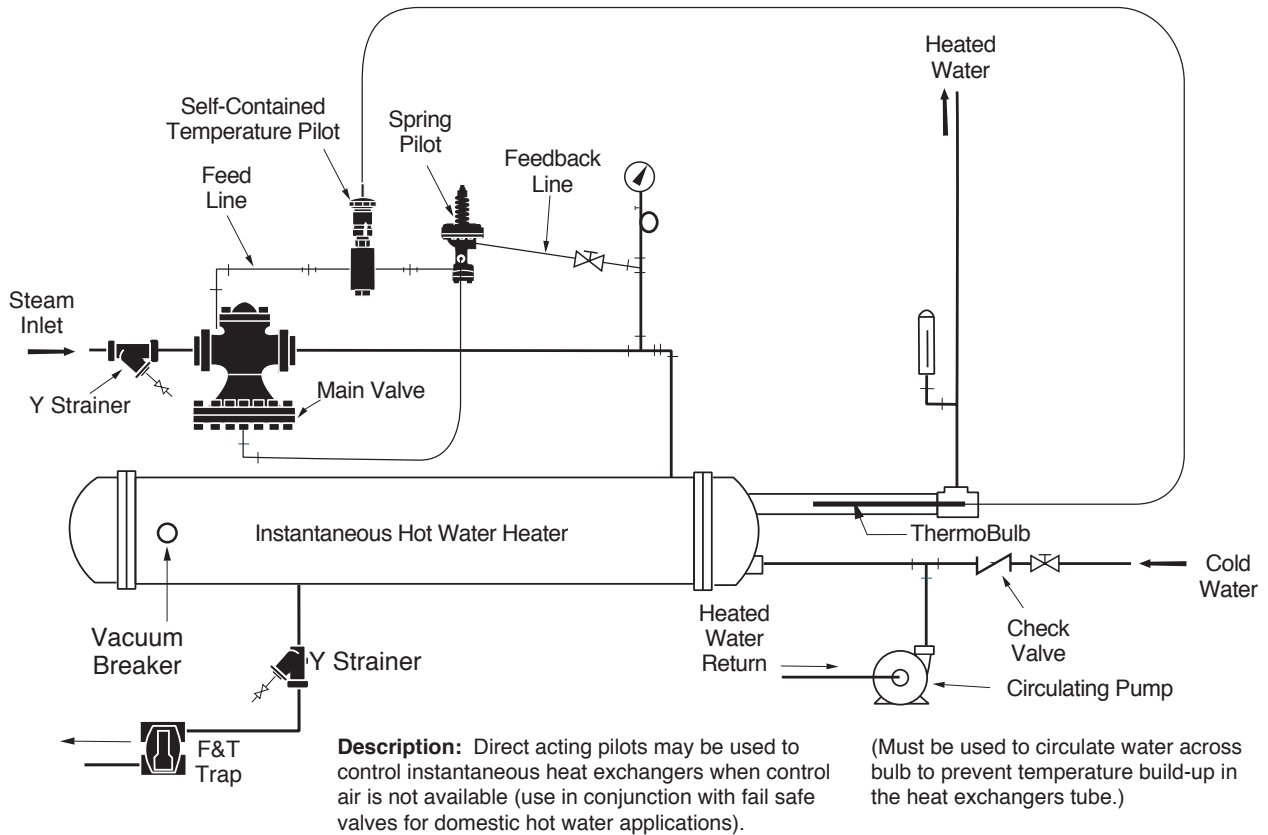

Storage Heater for Domestic Hot Water

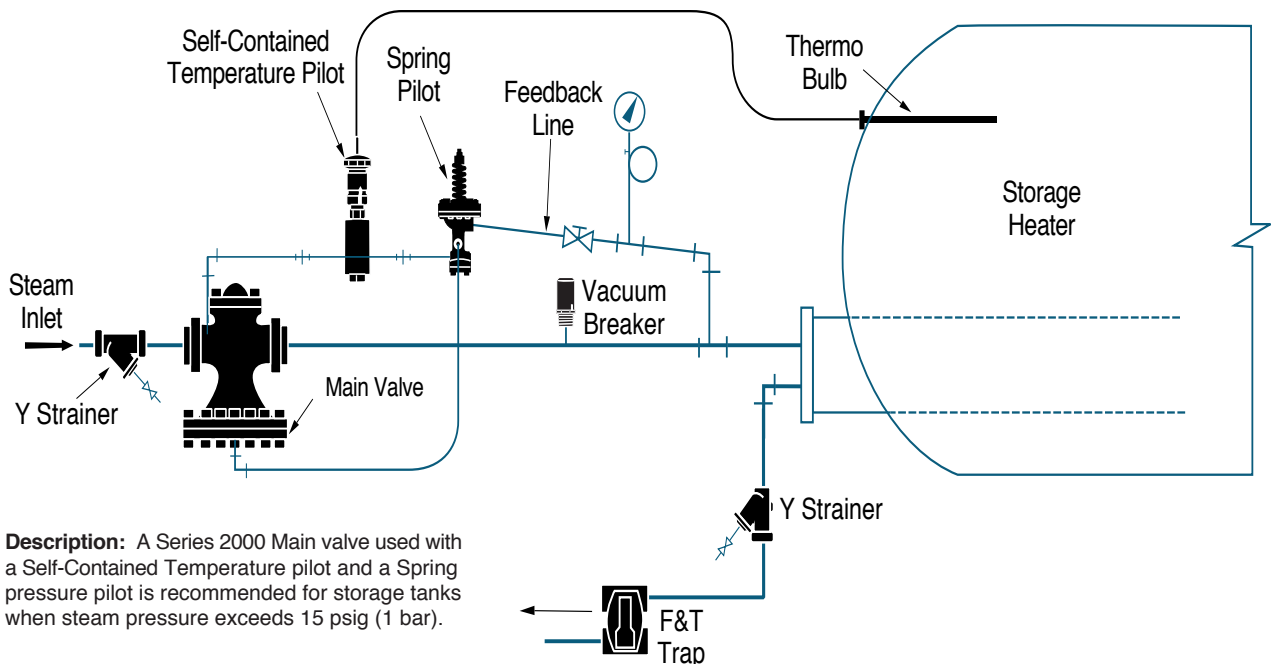

Series 2000 Typical Applications (continued)

Manual System Shut-off

For Operation at Regulator

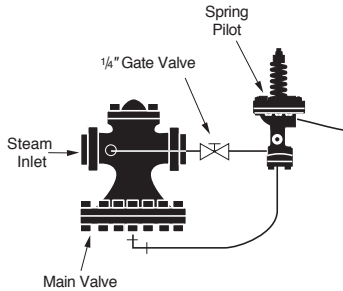

Description: A 1/4" NPT Gate valve may be added in the feed line to allow manual shutdown of the Main valve.

For Remote Operation up to 50' (15.2m) with 1/2" NPT

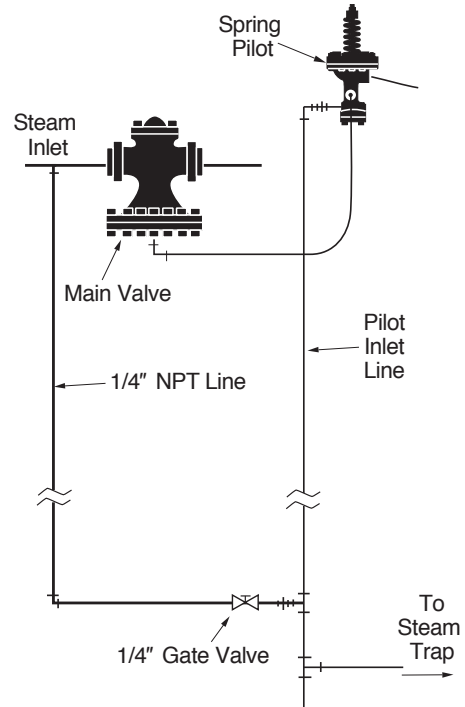

Remote Electrical Shut-off

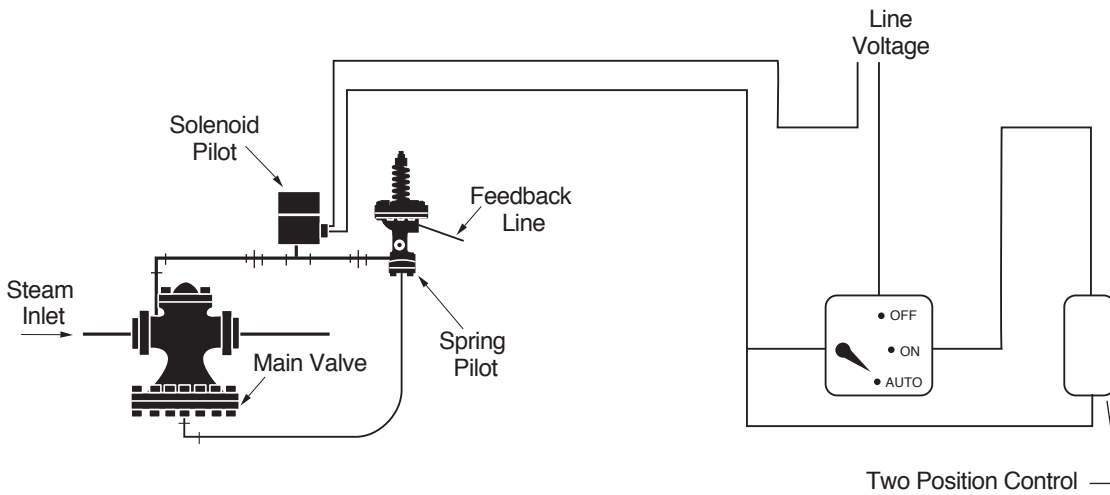

Description: A Solenoid pilot is used to electronically shutdown the flow of steam to the pilot, which will close the Main valve.

Series 2000 Typical Applications (continued)

Heating Converter Steam to Hydronic

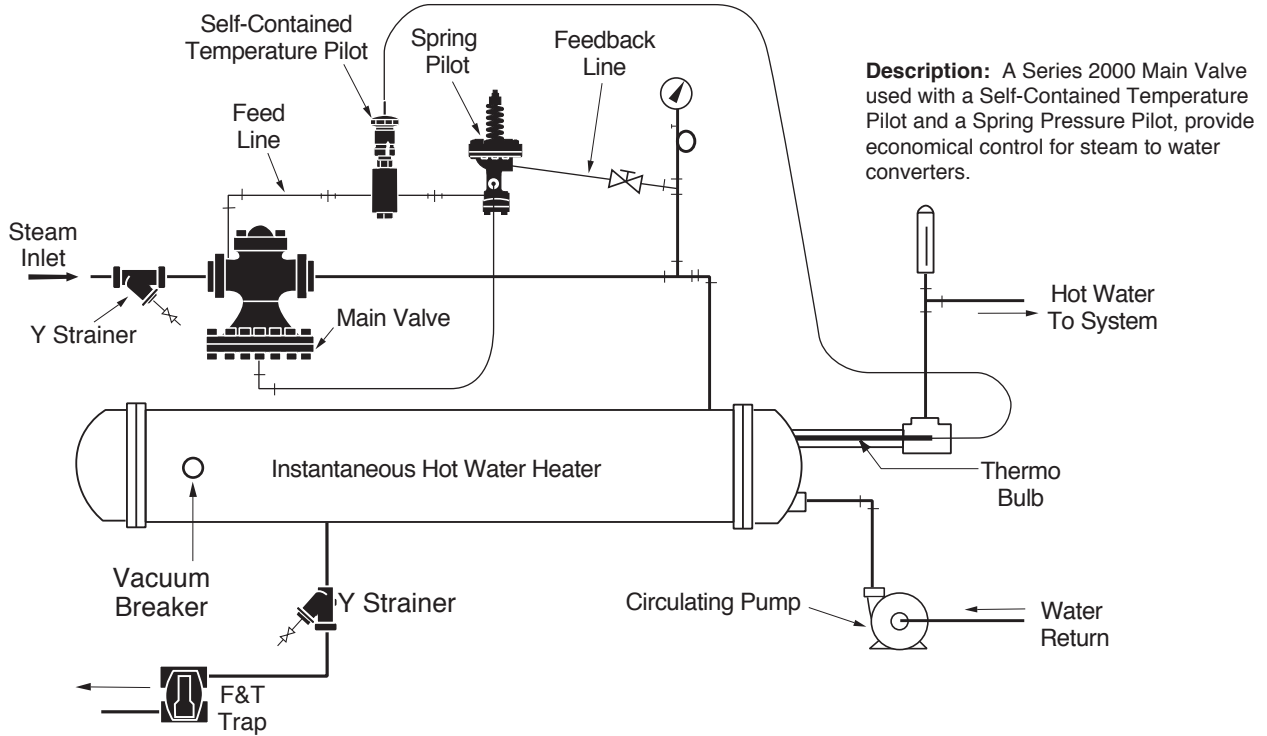

Oil Pre-heater Temperature Control

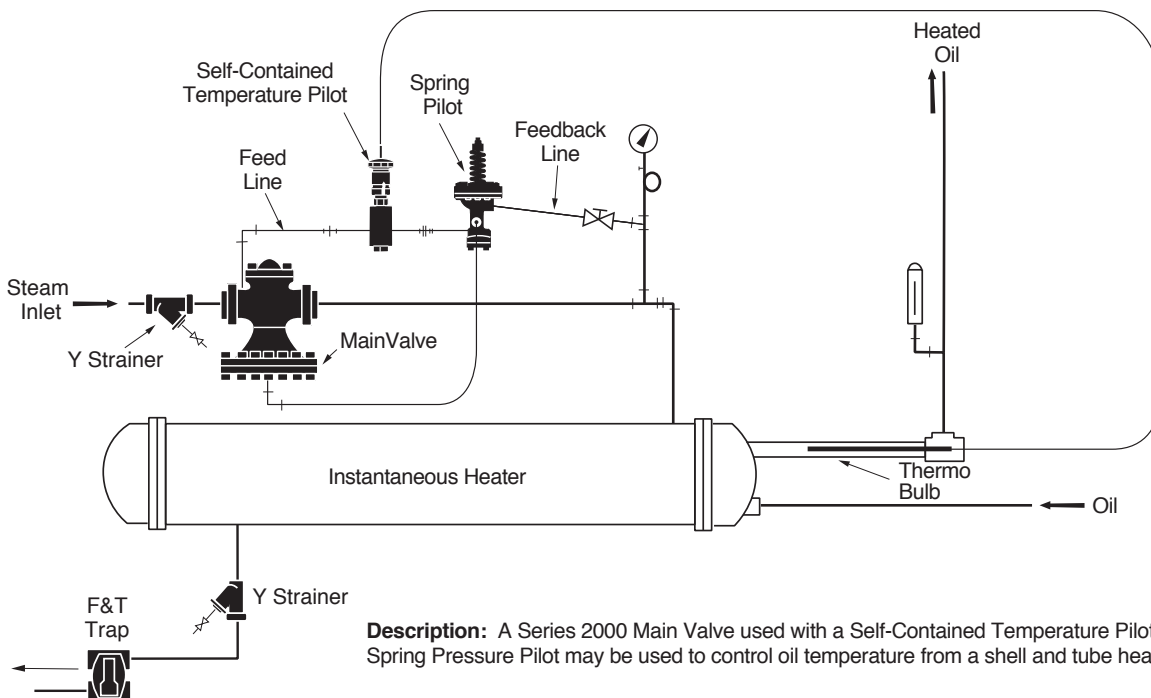

Series 2000 Typical Applications (continued)

Typical Two Stage Pressure Regulating Station with By-Pass

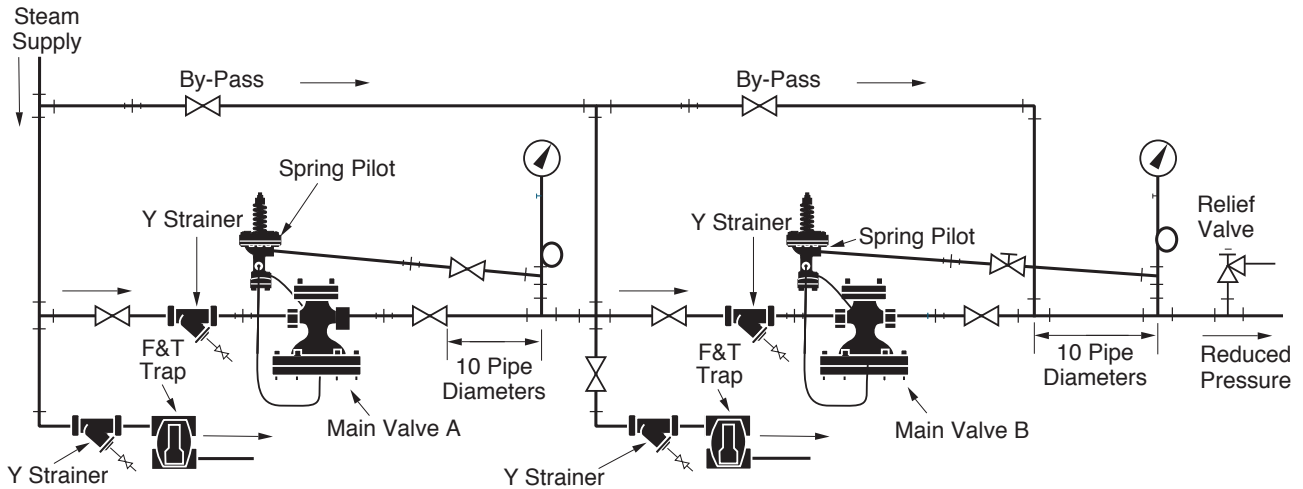

Description: The maximum pressure reduction for one valve is 150 psig (10.3 bar) although 100 psig (6.9 bar) is recommended. Two stage reduction should be used for pressure drops greater than 100 psig (6.9 bar).

Typical Two Stage Parallel Pressure Reduction with Intermediate Pressure Available

Description: Used when the load varies and the maximum pressure reduction is greater than 150 psig (10.3 bar) and 100 psig (6.9 bar) is the maximum recommended pressure reduction. Main valve A is sized for 1/3 the load 1/2 of the pressure reduction. Main valve B is sized for 1/3 the load and the other 1/2 of the pressure reduction. Main valves C and D are sized for the remaining 2/3 load.

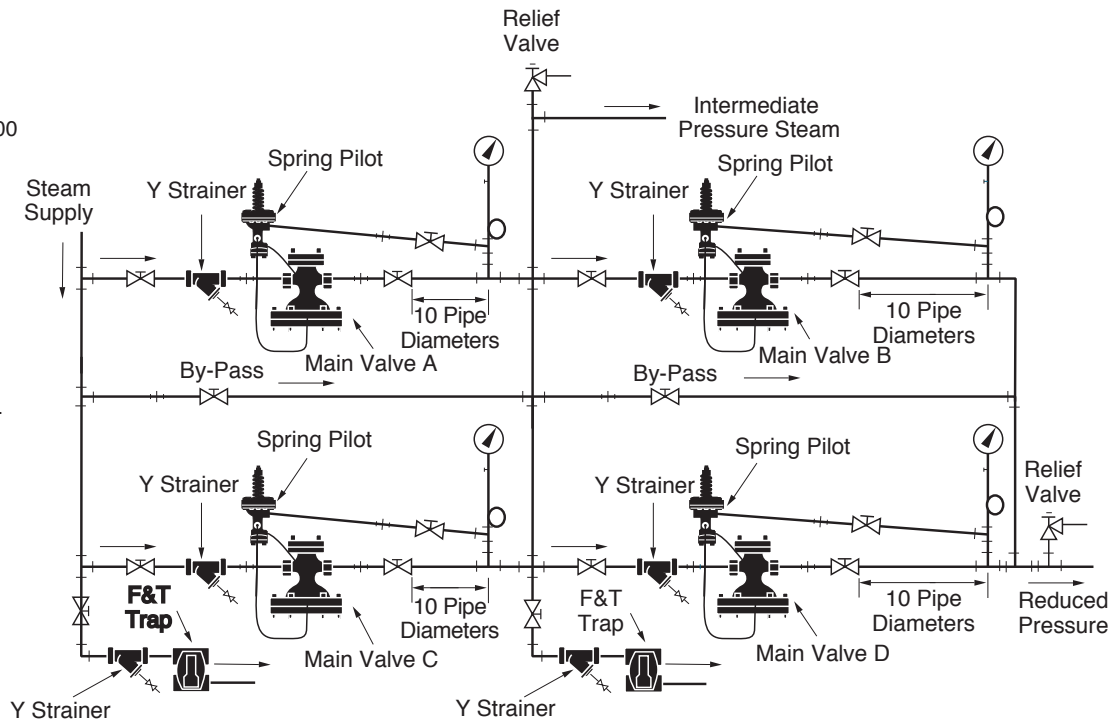

Series 2000 Typical Applications (continued)

Control of Temperature for Storage Tanks

Description: A Series 2000 Main Valve may be used to control temperature in a hot water storage tank. For low pressure steam applications use a Self-Contained Temperature pilot. For high pressure steam applications use a Self-Contained Temperature Pilot and a Spring Pressure Pilot.

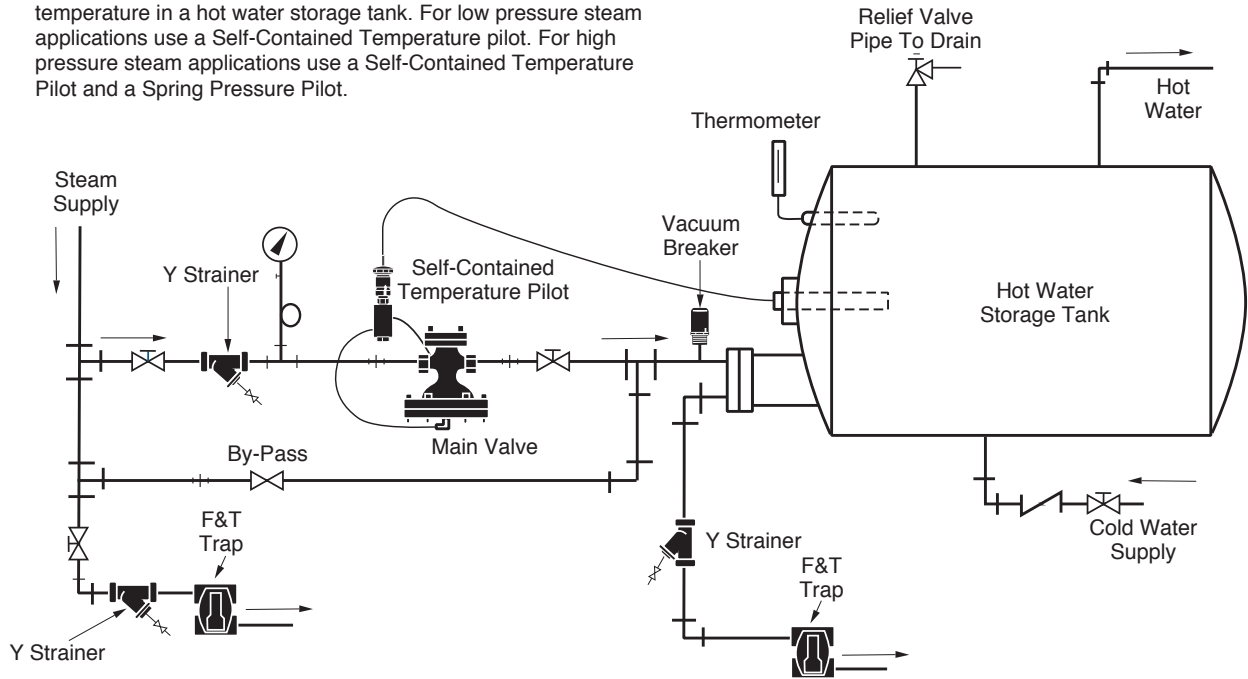

Control of Temperature for Storage Tanks

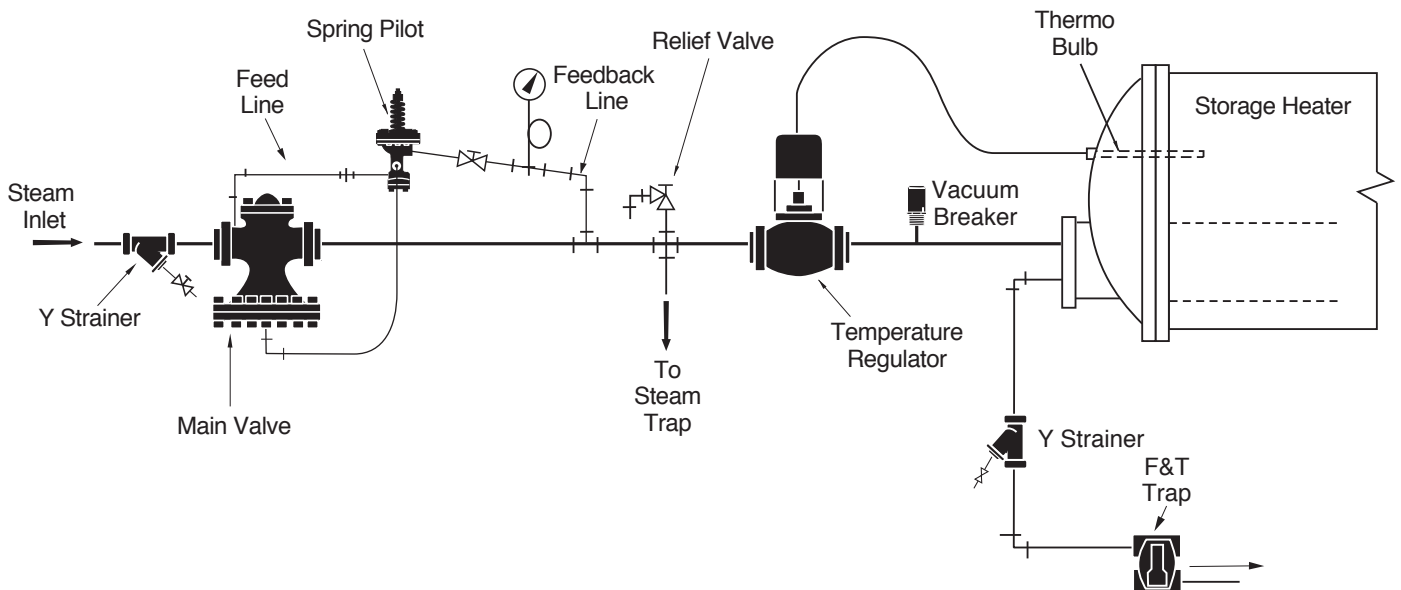

Description: A Series 2000 Main Valve and a Spring Pressure Pilot may be used to reduce steam pressure to a Direct-Acting Temperature Regulator.

Series 1140 & 1141 Temperature Regulators

How to Size Series 1140 & 1141 Regulators

For Steam

1. Use the Selection Data Chart (page 60) to determine the body code required.
2. Determine the capacity required by using the General Usage Formulas and tables (page 104).
3. Determine the available initial steam inlet pressure.
4. Determine the outlet pressure required, based on your heating or cooling equipment.
5. Use the capacity tables to select the regulator required.

Example:

What size regulator is required to heat 500 GPH (1892 LPH) of water from 60°F (15.5°C) to 160° (71.1°C) [100°F (55°C) temperature rise]? The regulator inlet pressure is 15 psig (1.0 bar) and the heat exchanger operating pressure is 9 psig (.6 bar).

Solution:

Use Table to determine the required capacity of 420 lbs./hr. (190 kg/hr.). Use the single seat body code 01 or 02 capacity tables. You can use a 1-1/4" NPT valve rated for 572 lbs./hr. (260 kg/hr.)

For Water

1. Use the Selection Data Chart (page 60) to determine the body code required.
2. Determine the capacity required by using the General Usage Formulas and tables (page 104).
3. Determine size required:
 - For **body codes 01, 02, and 02R** use Cv/Kv in capacity tables.
 - For **body codes 05, 05R, 06** use capacity graphs.

To determine the Cv when you know the required flow rate (in GPM) and the differential pressure; use the formula, page 104.

Gravity can be ignored when the water temperature is under 200°F (93°C).

Example:

To handle a maximum flow of 20 GPM at 22 psi differential, the Cv required is:

$$CV = \frac{20}{\sqrt{22}} = 4.26$$

Solution:

You can use a 3/4" body code 01 or 02 with an actuator for the required temperature.

Note: To convert GPM to LPM, multiply the GPM by 3.78.

Steam and Water Vents

Selection Guidelines – Steam Vents

Steam vents are used in one-pipe steam heating systems. As such, steam vents are primarily replacement items. Information required for sizing and selection:

1. Type of service

Determine the type of service where the vent is to be installed.

- a) Radiator Vent
- b) Convector Vent
- c) Main Vent

Model Number	Radiator (Angle type)	Convector (Bottom Inlet)	Unit Heater	Mains	Thermostatic Vent (only)
1A	X				
1B		X			
3					X
4					X
4A				X	
8C					X
40	X				
41		X			
43		X			
45		X			
70A	X				
71A		X			
71B		X			
71C		X			
74			X		
75				X	
75H				X	
76				X	
508		X			

2. System operating pressure

Determine the operating pressure of the steam system.

- (a) The rated operating pressure of the vent must be higher than the maximum operating pressure in the steam system. When the system pressure exceeds the vent operating pressure rating, the vent cannot open and air will remain in the system. Air in the system produces inefficient steam system operation.
- (b) On steam systems with pressures up to 125 psig, Thermostatic Traps such as Model 8C and 9C may be used as air vents.
- (c) Determine if the vent is to be installed in a vacuum system. The Model 76 Main Vent is for vacuum service. It should be used on systems with a vacuum pump or a vapor system with a coal or wood fired boiler. Systems converted from coal or wood fired to oil or gas should use non-vacuum vents such as the Model 75.

3. Connection size

Determine the NPT connection size where the vent is to be installed.

Steam and Water Vents (continued)

Selection Guidelines – Water Vents

Water vents are used in hydronic heating systems and chilled water systems to vent air out of the system. Information required for sizing and selection.

1. Type of service

Determine the type of service where the vent is to be installed.

- a) Radiator Vent
- b) Convector Vent
- c) Main Vent

Model Number	Radiator	Convector	Mains	Built-in Vacuum Check	Remarks
77	X	X			Small Systems
78			X	X	High Pressure
79			X	X	Low Pressure
790		X			Small Systems
791		X	X		Small Systems
792			X		Cast Iron Body
508	X	X			Moisture Type
550		X			Air Chamber

2. System operating pressure

Determine the operating pressure of the system. The rated operating pressure of the vent must be higher than the maximum system operating pressure. When the system pressure exceeds the vent operating pressure rating, the vent will remain closed and air will remain in the system.

3. Connection size

Determine the NPT connection size where the vent is to be installed.

4. Capacity

Vent capacity determines the speed that air is initially vented from the system. Once the system is initially filled with water, very little air should re-enter the system. Thus water vent capacity is relatively unimportant.

5. Additional features

The Model 792 water vent has a 1/4 NPT outlet in the cover. This allows the installation of a 1/4-inch gate valve for manual venting or testing of the vent.

Glossary of Terms

The definitions given in this section are only those applying to heating and particularly as used in this catalog. Some do not define the terms for all usages.

Absolute Humidity: The weight of water vapor in grains actually contained in one cubic foot of the mixture of air and moisture.

Absolute Pressure: The actual pressure above zero. It is the atmospheric pressure added to the gauge pressure. It is expressed as a unit pressure such as lbs.per sq. in. absolute.

Absolute Temperature: The temperature of a substance measured above absolute zero. To express a temperature as absolute temperature add 460° to the reading of a Fahrenheit thermometer or 273° to the reading of a Centigrade.

Absolute Zero: The temperature (-460°F. approx.) at which all molecular motion of a substance ceases, and at which the substance contains no heat.

Air: An elastic gas. It is a mechanical mixture of oxygen and nitrogen and slight traces of other gases. It may also contain moisture known as humidity. Dry air weighs 0.075 lbs. per cu. ft.

One Btu will raise the temperature of 55 cu. ft. of air one degree F.

Air expands or contracts approximately 1/490 of its volume for each degree of rise or fall in temperature from 32° F.

Air Change: The number of times in an hour the air in a room is changed either by mechanical means or by the infiltration of outside air leaking into the room through cracks around doors and windows, etc.

Air Cleaner: A device designed for the purpose of removing air-borne impurities such as dust, fumes, and smokes. (Air cleaners include air washers and air filters.)

Air Conditioning: The simultaneous control of the temperature, humidity, air motion, and air distribution within an enclosure. When human comfort and health are involved, a reasonable air purity with regard to dust, bacteria, and odors is also included. The primary requirement of a good air conditioning system is a good heating system.

Air Infiltration: The leakage of air into a house through cracks and crevices, doors, windows, and other openings, caused by wind pressure and/or temperature difference.

Air Valve: See Vent Valve.

Atmospheric Pressure: The weight of a column of air, one square inch in cross section and extending from the earth to the upper level of the blanket of air surrounding the earth. This air exerts a pressure of 14.7 pounds per square inch at sea level, where water will boil at 212°F. High altitudes have lower atmospheric pressure with correspondingly lower boiling point temperatures.

Boiler: A closed vessel in which steam is generated or in which water is heated by fire.

Boiler Feed Pump: A pump that is governed by a control that monitors the actual boiler water level; and only adds water to the boiler when the boiler needs it. The pump controller is mounted on the boiler.

Boiler Feed Unit: A pre-packaged system consisting of a tank, pump, and makeup water line that returns condensate to the boiler

Boiler Heating Surface: The area of the heat transmitting surfaces in contact with the water (or steam) in the boiler on one side and the fire or hot gases on the other.

Boiler Horsepower: The equivalent evaporation of 34.5 lbs. of water per hour at 212° F. to steam at 212° F. This is equal to a heat output of 33,475 Btu per hour, which is equal to approximately 140 sq. ft. of steam radiation (EDR) .

British Thermal Unit (BTU): The quantity of heat required to raise the temperature of 1 lb. of water 1°F. This is somewhat approximate but sufficiently accurate for any work discussed in this catalog.

BSPT: British Standard Pipe Thread

Bucket Trap (Inverted): A float trap with an open float. The float or bucket is open at the bottom. When the air or steam in the bucket has been replaced by condensate the bucket loses its buoyancy and when it sinks it opens a valve to permit condensate to be pushed into the return.

Bucket Trap (Open): The bucket (float) is open at the top. Water surrounding the bucket keeps it floating and the pin is pressed against its seat. Condensate from the system drains into the bucket. When enough has drained into it so that the bucket loses its buoyancy it sinks and pulls the pin off its seat and steam pressure forces the condensate out of the trap.

Calorie (Small): The quantity of heat required to raise 1 gram of water 1°C (approx.).

Calorie (Large): The quantity of heat required to raise 1 kilogram of water 1°C (approx.).

Cavitation: Term used to describe when condensate flashes into steam as it passes through a negative pressure in the eye of a centrifugal pump impeller. Steam pockets may form in the impeller eye and then implode as they enter a positive pressure in the impeller passage.

Centigrade: A thermometer scale at which the freezing point of water is 0° and its boiling is 100°.

Central Fan System: A mechanical indirect system of heating, ventilating, or air conditioning consisting of a central plant where the air is heated and/or conditioned and then circulated by fans or blowers through a system of distributing ducts.

Chimney Effect: The tendency in a duct or other vertical air passage for air to rise when heated due to its decrease in density.

Glossary of Terms (cont'd)

Coefficient of Heat Transmission (Over-all)-U-: The amount of heat (BTU) transmitted from air to air in one hour per square foot of the wall, floor, roof, or ceiling for a difference in temperature of one degree Fahrenheit between the air on the inside and outside of the wall, floor, roof, or ceiling.

Column Radiator: A type of direct radiator. This radiator has not been sold by manufacturers since 1926.

Comfort Line: The effective temperature at which the largest percentage of adults feel comfortable.

Comfort Zone (Average): The range of effective temperatures over which the majority of adults feel comfortable.

Concealed Radiator: See Convectector.

Condensate: Water formed by cooling steam. The capacity of traps, pumps, etc., is sometimes expressed in lbs. of condensate they will handle per hour. One pound of condensate per hour is equal to approximately 4 sq. ft. of steam heating surface (240 BTU per hour per sq. ft.).

Condensate Pump: A pump that is controlled by a switch mounted on the condensate tank. It adds water to the boiler when the condensate tank becomes full, whether the boiler needs water or not.

Condensate Return Rate: The rate at which condensate is returned to the boiler

Condensate Return (unit): A pre-packaged system consisting of a tank, pump, and usually a float switch that is used to pump condensate back to the boiler or boiler feed unit.

Conductance (Thermal)-C-: The amount of heat (BTU) transmitted from surface to surface, in one hour through one square foot of a material or construction for the thickness or type under consideration for a difference in temperature of one degree Fahrenheit between the two surfaces.

Conduction (Thermal): The transmission of heat through and by means of matter.

Conductivity (Thermal)-k-: The amount of heat (BTU) transmitted in one hour through one square foot of a homogenous material one inch thick for a difference in temperature of one degree Fahrenheit between the two surfaces of the material.

Conductor (Thermal): A material capable of readily transmitting heat by means of conduction.

Convection: The transmission of heat by the circulation (either natural or forced) of a liquid or a gas such as air. If natural, it is caused by the difference in weight of hotter and colder fluid.

Convectector: A concealed radiator. An enclosed heating unit located either within, adjacent to, or exterior to the room or space to be heated, but transferring heat to the room or space mainly by the process of convection. A shielded heating unit is also termed a convectector. If the heating unit is located exterior to the room or space to be heated, the heat is transferred through one or more ducts or pipes.

Convertor: A piece of equipment for heating water with steam without mixing the two. It may be used for supplying hot water for domestic purposes or for a hot water heating system.

Cooling Leg: A length of uninsulated pipe through which the condensate flows to a trap and which has sufficient cooling surface to permit the condensate to dissipate enough heat to prevent flashing when the trap opens. A thermostatic trap may require a cooling leg to permit the condensate to drop enough in temperature to permit the trap to open.

Degree-Day: (Standard) A unit which is the difference between 65° F. and the daily average temperature when it is below 65°F. The "degree day" on any given day is equal to the number of degrees F. that the average temperature for that day is below 65° F.

Dew-Point Temperature: The air temperature corresponding to saturation (100 percent relative humidity) for a given moisture content. It is the lowest temperature at which air can retain water vapor.

Direct-Indirect Heating Unit: A heating unit located in the room or space to be heated which is fully or partially closed. The enclosed portion is used to heat air which enters from outside the room.

Direct Radiator: Same as radiator.

Domestic Hot Water: Hot water used for purposes other than house heating such as laundering, dishwashing, bathing, etc.

Down-Feed One-Pipe Riser (Steam): A pipe which carries steam downward to the heating units and into which heating units drain condensation.

Down-Feed System (Steam): A steam heating system in which the supply mains are above the level of the heating units which they serve.

Dry-Bulb Temperature: The temperature of the air as determined by an ordinary thermometer.

Dry Return (Steam): A return pipe in a steam heating system which carries both condensation and air.

Dry Saturated Steam: Saturated steam containing no water in suspension.

Equivalent Direct Radiation (E.D.R.): The amount of heating surface which will give off 240 BTU per hour when filled with a heating medium at 215°F. and surrounded by air at 70° F. The equivalent square foot of heating surface may have no direct relation to the actual surface area.

Extended Heating Surface: Heating surface consisting of ribs, fins, or extended surfaces which receive heat by conduction from the prime surface.

Glossary of Terms (cont'd)

Extended Surface Heating Unit: A heating unit having a relatively large amount of extended surface which may be integral with the core containing the heating medium or assembled over a core, making good thermal contact by pressure, or by being soldered to the core or by both pressure and soldering. An extended surface heating unit is usually placed within an enclosure and functions as a convector.

Fahrenheit: A thermometer scale at which the freezing point of water is 32° and its boiling point is 212° above zero.

Flash (Steam): The rapid passing into steam of water at a high temperature when the pressure it is under is reduced so that its temperature is above that of its boiling point for the reduced pressure. For example: If hot condensate is discharged by a trap into a low pressure return or into the atmosphere, a certain percentage of the water will be immediately transformed into steam. It is also called re-evaporation .

Float & Thermostatic Trap: A float trap with a thermostatic element for permitting the escape of air into the return line.

Float Switch: A mechanical switch activated by a float on the end of a rod. This device is used in controlling the condensate pump, makeup valve, low water cutoff, etc.

Float Trap: A steam trap which is operated by a float. When enough condensate has drained (by gravity) into the trap body the float is lifted. In turn, the pin lifts off its seat. This permits the condensate to flow into the return until the float has been sufficiently lowered, to close the port. Temperature does not affect the operation of a float trap.

Furnace: That part of a boiler or warm air heating plant in which combustion takes place. Complete heating unit of a warm air heating system.

Gauge Pressure: The pressure above that of the atmosphere. It is the pressure indicated on an ordinary pressure gauge. It is expressed as a unit pressure such as lbs. per sq. in. gauge.

Head: Unit pressure usually expressed in ft. of water or mil-inches of water.

Heat: That form of energy into which all other forms may be changed. Heat always flows from a body of higher temperature to a body of lower temperature. See also: Latent Heat, Sensible Heat, Specific Heat, Total Heat, Heat of the Liquid.

Heat of the Liquid: The heat (Btu) contained in a liquid due to its temperature. The heat of the liquid for water is zero at 32° F. and increases 1 Btu approximately for every degree rise in temperature.

Heat Unit: In the foot-pound-second system, the British Thermal Unit (Btu) in the centimeter-gram-second system, the calorie (cal.).

Heating Medium: A substance such as water, steam, or air used to convey heat from the boiler, furnace, or other source of heat to the heating units from which the heat is dissipated.

Heating Surface: The exterior surface of a heating unit. See also Extended Heating Surface.

Heating Unit: Radiators, convectors, base boards, finned tubing, coils embedded in floor, wall, or ceiling, or any device which transmits the heat from the heating system to the room and its occupants.

Horsepower: A unit to indicate the time rate of doing work equal to 550 ft.-lb. per second, or 33,000 ft.-lb. per minute. One horsepower equals 2545 Btu per hour or 746 watts.

Hot Water Heating System: A heating system in which water is used as the medium by which heat is carried through pipes from the boiler to the heating units.

Humidistat: An instrument which controls the relative humidity of the air in a room.

Humidity: The water vapor mixed with air.

Insulation (Thermal): A material having a high resistance to heat flow.

Latent Heat of Evaporation: The heat (Btu per pound) necessary to change 1 pound of liquid into vapor without raising its temperature. In round numbers this is equal to 960 Btu per pound of water.

Latent Heat of Fusion: The heat necessary to melt one pound of a solid without raising the temperature of the resulting liquid. The latent heat of fusion of water (melting 1 pound of ice) is 144 Btu.

Low Pressure Steam: As defined by ASME, low pressure steam is 15 PSIG or less.

Low Water Cutoff: Float switch inside the boiler feed receiver set to prevent pumps from operating at low water level conditions.

Mechanical Equivalent of Heat: The mechanical energy equivalent to 1 Btu which is equal to 778 ft.-lb.

Mil-Inch: One one-thousandth of an inch (0.001").

NPSHR and NPSHA: Are short for Net Positive Suction Head Required and Net Positive Suction Head Available. NPSHR curves for centrifugal pumps are needed because all centrifugal pumps operate at a lower pressure in the impeller eye than the pressure existing at the pump suction flange. The curve identifies the pressure over and above fluid flash point or vaporization pressure, which is needed at the pump impeller eye and takes into account decreased pressures within the pump.

NPT: National Pipe Thread

One-Pipe Supply Riser (Steam): A pipe which carries steam to a heating unit and which also carries the condensation from the heating unit. In an up feed riser steam travels upwards and the condensate downward while in a down feed both steam and condensate travel down.

One-Pipe System (Hot Water): A hot water heating system in which one pipe serves both as a supply main and as a return main. The heating units have separate supply and return pipes but both are connected to the same main.

Glossary of Terms (cont'd)

One-Pipe System (Steam): A steam heating system consisting of a main circuit in which the steam and condensate flow in the same pipe. There is one connection to each heating unit which serves as both the supply and the return.

Overhead System: Any steam or hot water system in which the supply main is above the heating units. With a steam system the return must be below the heating units; with a water system, the return may be above the heating units.

Panel Heating: A method of heating involving the installation of the heating units (pipe coils) in the walls, floor or ceiling of the room.

Panel Radiator: A heating unit placed on, or flush with, a flat wall surface and intended to function as a radiator. Do not confuse with panel heating system.

Pilot Valve: A valve that uses a small valve to control a large valve.

Pressure: Force per unit area such as lb. per sq. inch. Unless otherwise qualified, it refers to unit static gauge pressure. See Static, Velocity, Total, Gauge and Absolute Pressures.

Pressure Powered Pump: Motorless pump that uses steam or air pressure to move condensate back to the boiler room.

Pressure Reducing Valve: A device used to decrease the pressure of a gas or liquid.

Prime Surface: A heating surface with the heating medium on one side and air (or extended surface) on the other.

Radiant Heating: A heating system in which the heating is by radiation only. Sometimes used in a Panel Heating System.

Radiation: The transmission of heat in a straight line through space.

Radiator: A heating unit located in the room to be heated and exposed to view. A radiator transfers heat by radiation to objects "it can see" and by conduction to the surrounding air which in turn is circulated by natural convection.

Recessed Radiator: A heating unit recessed in a wall but not enclosed.

Reducing Valve: See Pressure Reducing Valve.

Re-Evaporation: See Flash.

Refrigeration, Ton of: See Ton of Refrigeration.

Relative Humidity: The amount of moisture in a given quantity of air compared with the maximum amount of moisture the same quantity of air could hold at the same temperature. It is expressed as a percentage.

Return Mains: The pipes which return the heating medium from the heating units to the source of heat supply.

Reverse-Return System (Hot Water): A two-pipe hot water heating system in which the water from several heating units is returned along paths so that all radiator circuits of the system are of equal length

Sensible Heat: Heat which increases the temperature of objects as opposed to latent heat.

Specific Heat: In the foot-pound-second system, the amount of heat (Btu) required to raise one pound of a substance one degree Fahrenheit. In the centimeter-gram-second system, the amount of heat (cal.) required to raise one gram of a substance one degree C. The specific heat of water is 1.

Split System: A system in which the heating is accomplished by radiators or convectors and ventilation by separate apparatus.

Spurge Tube: Slotted tube inserted in the condensate return tank or boiler feed tank that injects steam to preheat the condensate. Normally uses waste steam to improve efficiency of the system.

Square Foot of Heating Surface: Equivalent direct radiation (EDR). By definition, that amount of heating surface which will give off 240 Btu per hour when filled with a heating medium at 215°F. and surrounded by air at 70° F. The equivalent square foot of heating surface may have no direct relation to the actual surface area.

Static Pressure: The pressure at which a pipe will burst. It is used to overcome the frictional resistance to flow through the pipe. It is expressed as a unit pressure and may be in absolute or gauge pressure. It is frequently expressed in feet of water column or in the case of pipe friction in mil-inches of water column per ft. of pipe.

Steam: Water in the vapor phase. The vapor formed when water has been heated to its boiling point, corresponding to the pressure it is under. See also Dry Saturated Steam, Wet Saturated Steam, Superheated Steam.

Steam Heating System: A heating system in which the heating units give up their heat to the room by condensing the steam furnished to them by a boiler or other source.

Steam Trap: A device for allowing the passage of condensate and air but preventing the passage of steam. See Thermostatic, Float and Thermostatic, Bucket Trap, Thermodisc Traps.

Storage Capacity: The volume of condensate that the condensate receiver is capable of holding.

Superheated Steam: Steam heated above the temperature corresponding to its pressure.

Supply Mains: The pipes through which the heating medium flows from the boiler or source of supply to the run-outs and risers leading to the heating units.

Tank Regulator: See Temperature Regulator.

Temperature Regulator: A device for controlling the admission of steam to a hot water or liquid heating device in correct quantities so that the temperature of the liquid will remain constant.

Glossary of Terms (cont'd)

Thermostat: An instrument which responds to changes in temperature and which directly or indirectly controls the room temperature.

Thermodisc Trap: A steam trap that operates by the cycling of a free-floating disc. The disc cycles in reaction to the inlet pressure of condensate and air against the bottom of the disc and pressure from flash steam that is trapped between the top of the disc and the trap cap chamber. Inlet pressure forces the disc off its seat. Flash steam, created from hot condensate reacting to the lower downstream pressure, builds pressure of top of the disc in the cap chamber and forces the disc down onto its seating surfaces. Pressure in the cap chamber drops due to cooling from natural heat losses. When the inlet pressure becomes greater than the cap chamber pressure, the cycle repeats.

Ton of Refrigeration: The heat which must be extracted from one ton (2,000 lbs.) of water at 32° F. to change it into ice at 32°F. in 24 hours. It is equal to 288,000 Btu/24 hours, 12,000 Btu/hour, or 200 Btu/minute.

Total Heat: The latent heat of vaporization added to the heat of the liquid with which it is in contact.

Total Pressure: The sum of the static and velocity pressures. It is also used as the total static pressure over an entire area, that is, the unit pressure multiplied by the area on which it acts.

Trap: See Steam Trap, Thermostatic Trap, Float Trap, Bucket Trap, Float and Thermostatic Trap and Themodisc Trap.

Tube Bundle: A single tube (pipe) formed into a tight array so as to present a large surface area in a small space.

Two-Pipe System (Steam or Water): A heating system in which one pipe is used for the supply main and another for the return main. In a two-pipe hot water system each heating unit receives a direct supply of the heating medium.

Unit Heater: A heating unit consisting of a heat transfer element, housing, fan with motor, and outlet deflectors or diffusers. It is usually suspended from the ceiling and its heat output is controlled by starting and stopping the fan by a room thermostat. The circulation of the heating medium (steam or hot water) is usually continuous. It is used primarily for industrial heating.

Unit Pressure: Pressure per unit area as lbs. per sq. in.

Up-Feed System (Hot Water or Steam): A heating system in which the supply mains are below the level of the heating units which they serve.

Vacuum Heating System (Steam): A one- or two-pipe heating system equipped with the necessary accessory apparatus to permit the pressure in the system to go below atmospheric.

Vapor: Any substance in the gaseous state.

Vapor Heating System (Steam): A two-pipe heating system which operates at or near atmospheric pressure and returns the condensation to the boiler or receiver by gravity.

Velocity Pressure: The pressure used to create the velocity of flow in a pipe. It is expressed as a unit pressure.

Ventilation: Air circulated through a room for ventilating purposes. It may be mechanically circulated with a blower system or through circulation with an open window, etc.

Vent Valve (Steam): A device that permits air to be forced out of a heating unit or pipe and closes against water and steam.

Vent Valve (Water): A device that permits air to be forced out of a heating unit or pipe and closes against water.

Warm Air Heating System: A warm air heating plant consists of a heating unit (fuel-burning furnace) enclosed in a casing, from which the heated air is distributed to the various rooms of the building through ducts. If the motive head producing flow depends on the difference in weight between the heated air leaving the casing and the cooler air entering the bottom of the casing, it is termed a gravity system. A booster fan may, however, be used in conjunction with a gravitydesigned system. If a fan is used to produce circulation and the system is designed especially for fan circulation, it is termed a fan furnace system or a central fan furnace system. A fan furnace system may include air washer, filters, etc.

Wet Bulb Temperature: The lowest temperature which a water-wetted body will attain when exposed to an air current.

Wet Return (Steam): That part of the return main of a steam heating system which is completely filled with water of condensation.

Wet Saturated Steam: Saturated steam containing some water particles in suspension.

Date Code Information

Hoffman Specialty products manufactured after 1972 feature a stamped date code, so you can easily check the life expectancy and recommended replacement intervals.

If a product has no date stamp or does not have the Bell & Gossett logo on it – consider replacing it.

Below are guides to help you translate the date code on Hoffman Specialty products.

 Bell & Gossett a xylem brand Product Date Code Translation		
Month	Year	Example
A = January	97 = 1979	K09 Translates to October 1990
B = February	08 = 1980	
C = March	18 = 1981	
D = April	28 = 1982	
E = May	38 = 1983	
F = June	48 = 1984	
G = July	58 = 1985	
H = August	68 = 1986	
J = September	78 = 1987	
K = October	88 = 1988	
L = November	98 = 1989	
M = December	09 = 1990	
	19 = 1991	
	29 = 1992	
	39 = 1993	
	49 = 1994	
	59 = 1995	
	96 = 1996	
	97 = 1997	Beginning 2009 month designator proceeds year and year designator is again reversed. K11 Translates to October 2011
	00 = 2000	
	01 = 2001	
	02 = 2002	
	03 = 2003	
	04 = 2004	
	05 = 2005	
	06 = 2006	
	07 = 2007	
	08 = 2008	
	09 = 2009	
	01 = 2010	
	11 = 2011	
	21 = 2012	
	31 = 2013	
	41 = 2014	
	51 = 2015	
	61 = 2016	
	71 = 2017	
	81 = 2018	
	91 = 2019	
	02 = 2020	

Warranty Policy

Bell & Gossett warrants for a period of two (2) years from the date of manufacture or one (1) year from date of installation, whichever comes first, that all Bell & Gossett and all Hoffman Specialty products furnished by it are free from defects in materials and workmanship.

Bell & Gossett's liability for any breach of this Warranty shall be limited solely to replacement or repair at the sole option of Bell & Gossett, of any part or parts found to be defective during the Warranty Period providing the Product is properly installed and is being used for its intended purpose. Buyer must notify Bell & Gossett of any breach of this warranty, within the aforementioned Warranty Period by notifying the Bell & Gossett representative with responsibility for servicing the Buyer's account. Further, product alleged to be defective must be shipped by buyer to Bell & Gossett's representative, transportation charges prepaid.

It is expressly agreed that this shall be the sole and exclusive remedy of the buyer, under no circumstances shall Bell & Gossett be liable for any costs, loss, expense, damages, special damages, incidental damages or consequential damages arising directly or indirectly from the design, manufacture, sale, or use or repair of the product whether based upon warranty, contract, negligence or strict liability. In no event will liability exceed the purchase price of the product.

The warranty and limits of liability contained herein are in lieu of all other warranties and liabilities expressed or implied. All implied warranties or merchantability and fitness for a particular purpose are hereby disclaimed by Bell & Gossett and excluded from the warranty.

Bell & Gossett neither assumes nor authorizes any person to assume for it, any other Warranty obligation in connection with the sale of the Product. This Warranty shall not apply to any product or parts of products which (a) have been repaired or altered outside of authorized Bell & Gossett facilities; (b) have been subject to misuse, negligence or accident; or (c) have been used in a manner contrary to Bell & Gossett instructions.

In the case of Products not manufactured by Bell & Gossett, there is no warranty from Bell & Gossett, but Bell & Gossett will extend to the buyer any Warranty from Bell & Gossett's supplier of such products

Return Goods Policy

Unused material may be returned for credit only with the written or oral consent of Bell & Gossett. This consent is in the form of an RGA number issued by Bell & Gossett, and is subject to the following conditions.

1. Materials must be unused, of current design, and in original cartons.
2. Credit will be issued based upon either a referenced invoice or product date code if an invoice is not referenced. Requester is to supply copy of the referenced invoice if requested.
3. A 25% restocking charge will apply.
4. Unauthorized material returned to Bell & Gossett will be either refused or sent back to the sender freight collect by a carrier chosen by Bell & Gossett.
5. If material is received but subsequently found not to have met the above conditions, it will be sent back to the sender freight collect by a carrier chosen by Bell & Gossett.
6. Products which are obsolete or made to special order are not returnable.

Warranty Procedure

Return product to place of purchase or contact our local Manufacturer's Representative.

Xylem |'zīləm|

- 1) The tissue in plants that brings water upward from the roots;
- 2) a leading global water technology company.

We're a global team unified in a common purpose: creating innovative solutions to meet our world's water needs. Developing new technologies that will improve the way water is used, conserved, and re-used in the future is central to our work. We move, treat, analyze, and return water to the environment, and we help people use water efficiently, in their homes, buildings, factories and farms. In more than 150 countries, we have strong, long-standing relationships with customers who know us for our powerful combination of leading product brands and applications expertise, backed by a legacy of innovation.

For more information on how Xylem can help you, go to www.xylem.com

The Little Red Schoolhouse® - Training the Industry



Seminars currently offered are:

- Modern Hydronic System Design - Basic*
- Modern Hydronic System Design - Advanced*
- Design & Application of Water Based HVAC Systems
- Large Chilled Water System Design*
- Pump Service & Maintenance School
- Steam Systems Design & Applications
- Steam System Operation & Maintenance
- Plumbing Systems Design

Bell & Gossett has long been known for its dedication to training. The "Little Red Schoolhouse®" has graduated over 60,000 students since it was founded in 1954.

Graduates from the "Little Red Schoolhouse" may be found throughout North America, Europe, Africa, Asia and Australia.

For applications to attend these seminars, please contact a Bell & Gossett Representative in your area. They will have the schedule dates for all seminars and will make all the arrangements for you. As a service and a continuing educational source to the HVAC industry, these seminars are offered free of charge. IACET certified CEU credits are awarded for each seminar.

* The USGBC has approved the technical and instructional quality of the Modern Hydronic Heating Systems - Basic Seminar (15 GBCI CE Hours) and the Large Chilled Water Design Seminar (11 GBCI CE Hours). These courses are approved for GBCI Continuing Education Hours towards LEED Credential Maintenance Programs.



Xylem Inc.
8200 N. Austin Avenue
Morton Grove, Illinois 60053
Phone: (847) 966-3700
Fax: (847) 965-8379
www.bellgossett.com