

# NIBCO®

AHEAD OF THE FLOW®

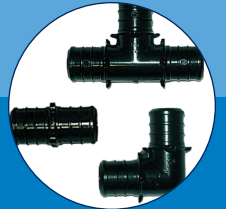
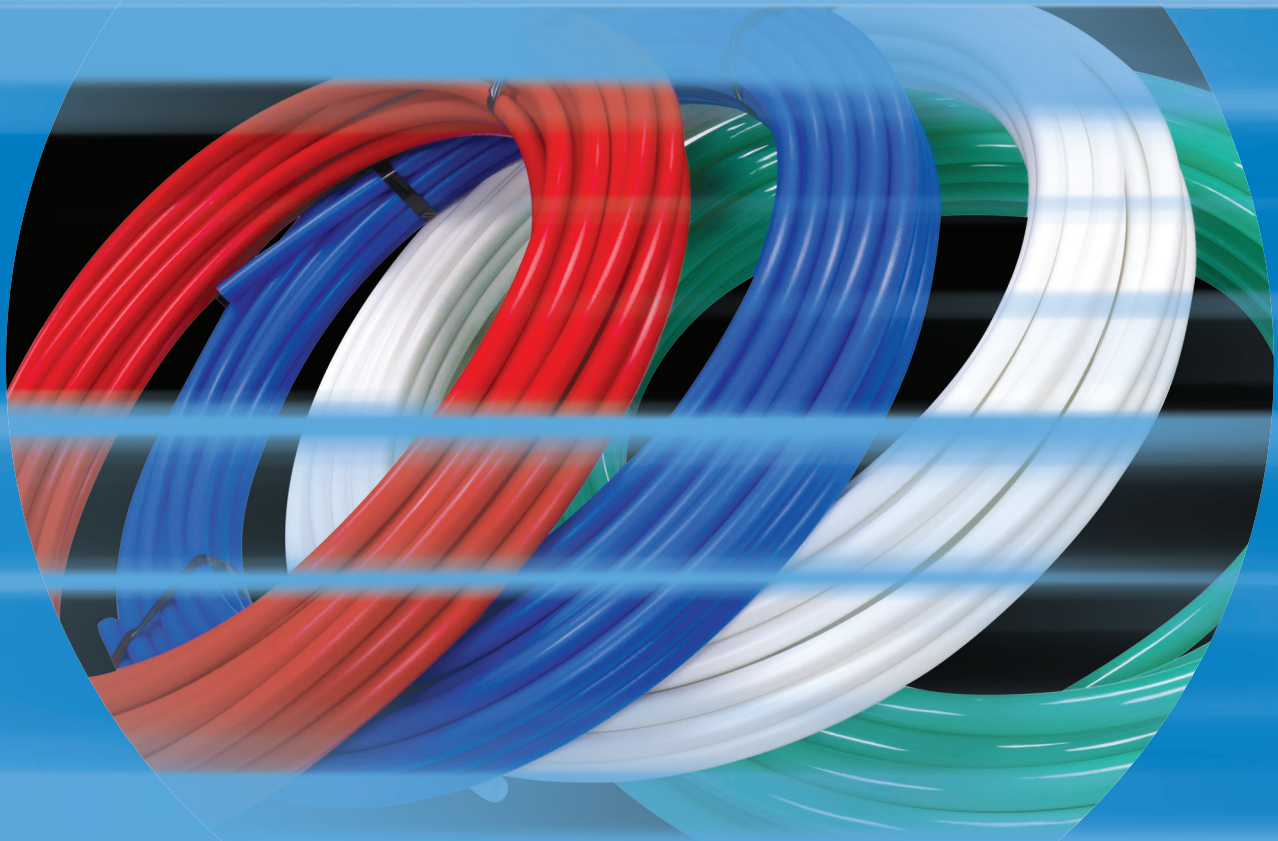

NIBCO® Flexible  
Piping Systems

# Business-to-Business Solutions

Look to NIBCO for technology leadership.

The velocity with which e-business evolves demands that new products and services be continuously developed and introduced to keep our customers at the center of our business efforts. NIBCO provides an entire suite of business-to-business solutions that is changing the way we interact with customers.



**NIBCOpartner.com<sup>SM</sup>** is an exclusive set of secure web applications that allow quick access to customer-specific information and online order processing. This self-service approach gives you 24/7 access to your order status putting you in total control of your business.

Real time information includes:

- Online order entry
- Viewable invoices & reports
- Inventory availability
- Current price checks
- Order status
- Online library of price sheets, catalogs & submittals



**Electronic Data Interchange (EDI)** makes it possible to trade business documents at the speed of light. This technology cuts the cost of each transaction by eliminating the manual labor and paperwork involved in traditional order taking. This amounts to cost-savings, increased accuracy and better use of resources.

With EDI, you can trade:

- Purchase orders
- PO Acknowledgements
- Invoices
- Product activity data
- Advanced ship notices
- Remittance advice



**Vendor Managed Inventory (VMI)**, a sophisticated service for automated inventory management, reduces your overhead by transferring inventory management, order entry and forecasting to NIBCO. This is an on-going, interactive partnership with NIBCO.

Through automation, VMI brings results:

- Improves customer service
- Optimum inventory efficiencies
- Better forecasting
- Cuts transaction costs
- Peace of mind
- Relief from day-to-day management



*Visit our website for the most current information.*

## Table Of Contents

Introduction.....	4
Material Selection.....	6
NIBCO <sup>®</sup> PE-RT.....	10
NIBCO <sup>®</sup> PEX-c.....	12
NIBCO <sup>®</sup> PEX-b.....	17
NIBCO <sup>®</sup> Barrier PE-RT.....	18
NIBCO <sup>®</sup> Barrier PEX.....	19
Metal Insert Fittings.....	20
Plastic Insert Fittings.....	25
Multiport Tees.....	27
Connections (Crimp Rings and Sleeves).....	28
Manifolds.....	29
Valves.....	33
Radiant Heating.....	34
Tools.....	37
Installation Accessories.....	40
NIBCO <sup>®</sup> PEX Warranty.....	41
NIBCO <sup>®</sup> PE-RT Warranty.....	42
Quick Reference Guide.....	44

## NIBCO® Flexible Piping is a Complete System

NIBCO® PEX and PE-RT tubing, fittings, valves, and manifolds are designed to be used as a complete system. Therefore, NIBCO cannot guarantee that tubing and/or components from other systems are compatible for use with the NIBCO® Flexible Piping system. NIBCO offers more versatility with the choice of three different connections - copper crimp ring, copper crimp sleeve, and stainless steel sleeve.

## The NIBCO® PEX Manufacturing Process

Cross-linking is the process that gives NIBCO® PEX tubing its superior characteristics. The long, simple chains in a polyethylene molecule are altered to form a more stable, three-dimensional network. This process changes the material from a thermoplastic into a thermoset. A thermoset differs from a thermoplastic because a thermoset cannot be melted and then reformed. This change in molecular structure creates a polyethylene product with enhanced mechanical properties.

## Standards and Approvals

NIBCO® PEX is an outside diameter controlled tubing of one standard dimension ratio (SDR 9) that is manufactured to comply with the requirements of CSA B137.5, ASTM F 876, and ASTM F 2023. NIBCO® PEX insert fittings and copper crimp rings are manufactured to comply with CSA B137.5 and ASTM F 1807. NIBCO® PEX tubing, fittings, and crimp rings are tested as a system to the requirements of ASTM F 877. NIBCO® PEX tubing components are listed for compliance to NSF/ANSI 14 and NSF/ANSI 61 by NSF International for use in potable water systems. NIBCO® PEX tubing has also been tested and certified by the International Association of Plumbing and Mechanical Officials (IAPMO).



NIBCO® PE-RT is an outside diameter controlled tubing of one standard dimension ratio (SDR 9) that is manufactured to comply with the requirements of CSA B137.18, ASTM F2769, and ASTM F 2023. NIBCO® PE-RT tubing is listed for compliance to NSF/ANSI 14 and NSF/ANSI 61 by NSF International for use in potable water systems.

## Operating Limits

Water: 160 PSI @ 73° F (1.10 MPa @ 23° C)  
100 PSI @ 180° F (0.69 MPa @ 82° C)  
80 PSI @ 200° F (0.55 MPa @ 93° C)

Chlorinated Water: 80 PSI @ 140° F (0.55 MPa @ 60° C)

The water temperature must be 140° F (60° C) or lower and the water pressure must be 80 PSI (0.55 MPa) or lower

## Thermal Expansion

Heated water expands and must be accommodated within the plumbing system. Protection against increased water pressure from thermal expansion utilizing a pressure relief valve and expansion tank to keep pressure under the maximum of 80 PSI (0.55 MPa) must be incorporated in the system.

*Visit our website for the most current information.*

## Installation Notes

Use of recirculating loops with hot water distribution is gaining popularity in some areas of the country. However, there is debate about the efficiency of these systems due to the constant heating of hot water including during periods of low demand. Data published in the PPI/PPFA/NAHB PEX Design Guide shows a properly designed Home Run manifold system can reduce time to deliver hot water and water use 30 – 40% without recirculation.

If recirculating loops are used with NIBCO PEX-C, the use of a timer is recommended and the following conditions must be observed:

Max Pressure	80 psi @ 140°F
Max Recirculation Time	12 hrs/day

Please note many building codes forbid constant recirculation and require the use of a timer or other device to make water heating periodic in nature.

*Visit our website for the most current information.*

# Material Selection

## Plastic Piping Standards

Many commercial, industrial, and governmental standards or specifications are available to assist the design engineer in specifying plastic piping systems. Standards most frequently specified in plastic piping systems are American Society for Testing and Materials (ASTM) Standards. Below is a list and description of those standards most typically applied to industrial plastic piping.

### Polyethylene (PE)

Polyethylene is the most common olefin material and is typically used in transporting water. Because olefins cannot be joined with cements, barbed insert fittings are used for mechanical assembly. PE is light weight, low cost, has excellent chemical resistance, low coefficient of friction, and is non-toxic.

### Cross-Linked Polyethylene (PEX)

PEX is the common name for cross-linked polyethylene. PEX tubing is predominantly used in water distribution systems, hydronic radiant heating systems, and natural gas systems.

Almost all PEX is made from high density polyethylene (HDPE). PEX contains cross-linked bonds that are introduced into the polymer structure, changing the thermoplastic into a thermoset. Cross-linking is accomplished during or after the extrusion of the tubing. The required degree of cross-linking, according to ASTM F 876, is between 65 to 89 percent.

The cross-linking process improves high-temperature mechanical properties, low-temperature impact, tensile strength, resistance to brittle fracture, and scratch resistance properties.

Cross-linking may be done by the peroxide (Engel) method, silane (moisture cure) method, or electron beam method.

### Polyphenylsulfone (PPSU)

Polyphenylsulfone is a thermoplastic that is tough, rigid, high-strength, and retains its properties between -148° F and 302° F (-100° C and 150° C). PPSU has very high dimensional stability; the size change when exposed to boiling water or 302° F (150° C) air generally falls below 0.1 percent. Polyphenylsulfone is highly resistant to mineral acids, alkali, and electrolytes, in pH ranging from 2 to 13. PPSU is resistant to oxidizing agents; therefore, can be cleaned by bleaches. Also, PPSU is resistant to surfactants and hydrocarbon oils. However, PPSU is not resistant to low-polar organic solvents (e.g., ketones and chlorinated hydrocarbons) and aromatic hydrocarbons. In addition, PPSU is often chosen for difficult applications including high water temperatures, chlorides, or when water quality may increase the risk of dezincification, a type of corrosion that can adversely affect metal fittings.

### Brass

Brass is the term used for copper alloys where zinc is the principle alloying element along with copper. Brass has a yellow color, somewhat similar to gold. Brass plumbing components may be machined from extruded shapes, forged, or cast. This alloy is mainly used for decorative fixtures, plumbing components, and electrical applications. Today, almost 90% of all brass alloys are recycled.

### Copper (Cu)

Copper (Cu) is a natural element that has historically been the dominant material used in plumbing, heating, cooling, and other piping applications. Copper is a ductile metal with excellent thermal conductivity and is corrosion resistant. The materials used in copper piping products comply with the requirements of specifications established by the American Society for Testing and Materials (ASTM). The alloy customarily used for copper tube and copper fittings is designated as C12200 (Copper No. 122). This alloy contains a minimum of 99.9% pure copper and is deoxidized by the addition of phosphorus. Other copper alloys may be used.

Visit our website for the most current information.

# Material Selection

## Plastic Piping Standards

### NSF/ANSI 61

Drinking Water System Components - Health Effects. This is the American National Standard for health effects of drinking water system components. This standard establishes the health effects requirements for the chemical contaminants and impurities that are indirectly imparted to drinking water from products, components and materials used in drinking water systems. This Standard is maintained by a Joint Committee with equal representation from regulators (such as; EPA, Health Canada, and state drinking water officials), users (such as; water purveyors, utilities, and engineers) and manufacturers. NSF/ANSI Standard 61 is approved by the American National Standards Institute, which ensures the standard is developed and maintained using an open consensus process and has representation by all stakeholders.

### NSF/ANSI 14

Plastics Piping System Components and Related Materials. NSF/ANSI Standard 14 establishes minimum physical, performance, health effects, quality assurance, marking, and record keeping requirements for plastic piping components and related materials such as: Thermoplastic Materials, Thermoset Materials, Non-plastic Components, Piping and Tubing, Fittings and Valves, Appurtenances, Joining Materials, and Gaskets, Ingredients of Materials and Special Engineered Products and Materials. Standard 14 outlines production facility inspection, quality control, short-term performance testing, long-term performance evaluation, and chemical extraction testing of the products to ensure continued compliance. The NSF Mark for these certified products include such things as the manufacturer name or trademark; the certification agency/laboratory name or trademark; the reference performance standard (such as ASTM F 876 and F 877); product end use (pw or rfh), material type designation such as PEX or PEX/AL/PEX; product size, date of production and manufacturer identification code for tubing. For products with size constraints that do not accommodate complete marking, the manufacturer must include all such details on the product packaging.

### ASTM Standard F 876

Standard Specification for Cross-linked Polyethylene (PEX) Tubing. This Standard contains finite dimensional requirements for tubing in addition to burst, sustained pressure, and other relevant performance tests at different water temperatures.

### ASTM Standard F 877

Standard Specification for Cross-linked Polyethylene (PEX) Plastic Hot- and Cold-Water Distribution Systems. This Standard contains performance requirements for PEX tubing and fittings systems. Also, this Standard contains test methods and methods

of marking for components used in PEX hot- and cold-water distribution systems intended for 100 psi (0.69 MPa) water service up to and including 180°F (82°C).

### ASTM Standard F 1807

Standard Specification for Metal Insert Fittings Utilizing a Copper Crimp Ring for SDR9 Cross-linked Polyethylene (PEX) Tubing. This Standard contains material and dimensional requirements for the insert fittings and crimp rings used with PEX tubing. The performance requirements for these products are defined within ASTM F 877.

### ASTM Standard F 2098

Specification for Stainless Steel Clamps for Securing SDR9 Cross-Linked Polyethylene (PEX) Tubing to Metal Insert Fittings. This standard covers stainless steel clamps for use with insert fittings that comply with ASTM F 1807, and cross-linked polyethylene (PEX) tubing that complies with ASTM F 876. These clamps are intended as an alternative to the copper-alloy crimp-rings defined in ASTM F 1807 or ASTM F 2159 and for use in 100 psi (689.5 kPa) hot- and cold-water distribution systems operating at temperatures up to and including 180°F (82°C). This Standard includes requirements for materials, workmanship, dimensions, and marking of the stainless steel clamps. Also, these clamps are covered by international patents held by Oetiker International.

### ASTM Standard F 2159

Specification for Plastic Insert Fittings Utilizing a Copper Crimp Ring for SDR9 Cross-linked Polyethylene (PEX) Tubing. This Standard covers Polyphenylsulfone insert fittings and copper crimp rings for use with cross-linked polyethylene (PEX) tubing. These fittings are intended for use in 100 psi (689.5 kPa) hot- and cold-water distribution systems operating at temperatures up to and including 180°F (82°C). This Standard includes requirements for material, molded part properties, performance, workmanship, dimensions, and markings for the fittings and rings.

### ASTM F2769

Standard Specification for Polyethylene Raised Temperature (PE-RT) Tubing. This Standard contains dimensional requirements for tubing in addition to burst, sustained pressure, and other relevant performance tests at different water temperatures.

Visit our website for the most current information.

# Material Selection

## Plastic Piping Standards

### ASSE Standard 1061

Removable and Non-Removable Push-Fit Fittings. This Standard covers removable and non-removable push-fit fittings that employ a quick assembly push-fit connector, as well as push-fit connectors integrated into plumbing devices. This Standard applies to fittings that may be approved for use with PEX tubing that conforms to ASTM F 876, Type K, L, and M seamless copper tubing that conforms to ASTM B 88, and CPVC tubing that conforms to ASTM D 2846. The standard includes minimum requirements for materials, performance for the fitting joints, marking, and identification requirements. When this type of fitting connection is used with PEX tubing, a tube liner must be inserted into the end of the tubing before assembly.

### NSF-pw

Identification mark for products that meet all applicable performance standards for pressure-rated potable water applications as required by NSF/ANSI Standard 14 and that comply with NSF/ANSI Standard 61 for health effects.

### NSF-rfh

Identification mark for products that meet all applicable performance standards for a pressure-rated in-floor heating application as required by NSF/ANSI Standard 14. No health effects evaluation is required.

### NSF-61

Identification mark for products that meet the applicable requirements of NSF/ANSI 61.

### California Proposition 65

In November 1986, California voters approved a ballot initiative to address concerns about exposures to toxic chemicals. That initiative became The Safe Drinking Water and Toxic Enforcement Act of 1986, better known by its original name, Proposition 65. This Proposition requires the Governor of California to publish a list of chemicals that are known to the State of California to cause cancer, birth defects or other reproductive harm. Over 750 chemicals and materials, including many metals and plastics, have been listed as of December 12, 2006. Second, Manufacturers are required to provide a "clear and reasonable" warning before exposing anyone to a listed chemical. This warning can be given by a variety of means, such as by labeling a consumer product, by posting signs at the workplace, or by publishing notices in a newspaper. A Proposition 65 warning means that the Manufacturer issuing the warning believes that one or more listed chemicals is present in its product, even if it is only present in trace quantities.

### Kentucky

Metal insert fittings utilizing a copper crimp ring for cross-linked polyethylene (PEX) tubing must be produced and labeled as ASTM F 1807. Stainless steel clamps substituted for the copper crimp ring must be produced and labeled as ASTM F 2098. Methods of joining other than mentioned above shall be prohibited unless documentation is provided, from the systems manufacturer, honoring full warranty of the system installed. Fittings which have a smaller ID (inside diameter) other than what is required for the insert portion of the fitting shall not be permitted. A system consisting of material from multiple manufacturers (i.e. fittings, tubing and crimp rings) shall be prohibited unless documentation from manufacturers is produced providing full warranty. Connections for PEX systems other than those in section 1 of this regulation will be prohibited.

*Visit our website for the most current information.*



# Fitting Terms and Abbreviations

FIP = Female Iron Pipe  
MIP = Male Iron Pipe  
NPSM = Straight Pipe Thread  
CTS = Copper Tube Size

SVL = Swivel  
PB = Polybutylene

## Tube Markings

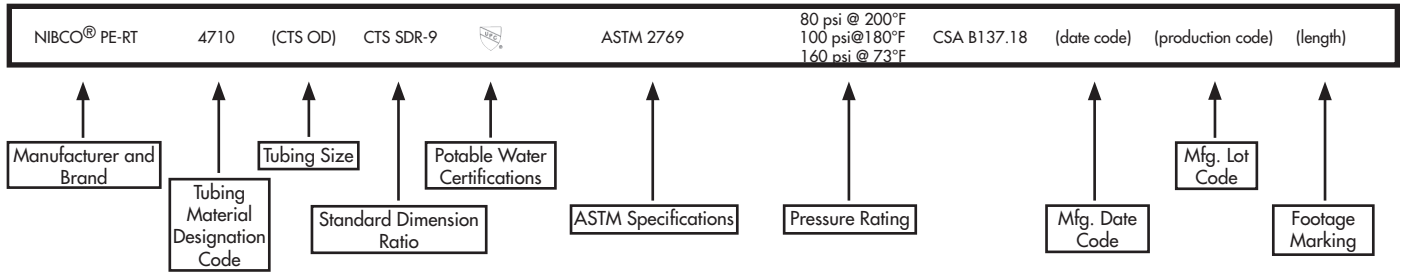
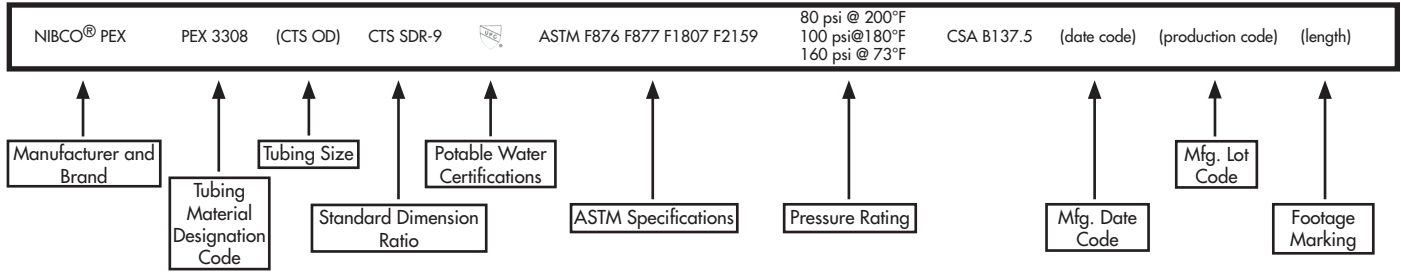

Visit our website for the most current information.

**NIBCO® PE-RT TUBE**  
POTABLE WATER

**NIBCO®**  
**PERTpro™**

**RED**

**PT60**



**PE-RT RED STICKS**

Figure No.	Material No.	Size	Weight/ Foot	Weight/ Stick	Feet/ Bundle	Pieces/ Bundle
PT60	PT60014P	1/2 x 20	0.0540	1.08	1,000	50
PT60	PT60021P	3/4 x 20	0.1025	2.05	500	25
PT60	PT60027P	1 x 20	0.1670	3.34	300	15

**PT60**



**PE-RT RED COIL**

Figure No.	Material No.	Size	Weight/ Foot	Weight/ Coil	Feet/ Pallet	Coils/ Pallet
PT60	PT40014P	1/2 x 100	0.0540	5.40	2,000	20
PT60	PT40018P	1/2 x 250	0.0540	13.50	2,500	10
PT60	PT40020P	1/2 x 500	0.0540	27.00	4,000	8
PT60	PT40030P	3/4 x 100	0.1025	10.25	1,300	13
PT60	PT40034P	3/4 x 250	0.1025	25.63	2,250	9

**WHITE**

**PT80**



**PE-RT WHITE STICKS**

Figure No.	Material No.	Size	Weight/ Foot	Weight/ Stick	Feet/ Bundle	Pieces/ Bundle
PT80	PT60214P	1/2 x 20	0.0540	1.08	1,000	50
PT80	PT60221P	3/4 x 20	0.1025	2.05	500	25
PT80	PT60227P	1 x 20	0.1670	3.34	300	15
PT80	PT60231P	1-1/4 x 20	0.2530	5.06	200	10

All sticks sold in 5 bundle minimum quantity. Sizes and colors can be mixed to make up the 5 bundle minimum.

**PT80**



**PE-RT WHITE COIL**

Figure No.	Material No.	Size	Weight/ Foot	Weight/ Coil	Feet/ Pallet	Coils/ Pallet
PT80	PT40201P	1/4 x 100	0.0300	3.00	4,000	40
PT80	PT40205P	3/8 x 100	0.0410	4.10	3,500	35
PT80	PT40214P	1/2 x 100	0.0540	5.40	2,000	20
PT80	PT40220P	1/2 x 500	0.0540	27.00	4,000	8
PT80	PT40230P	3/4 x 100	0.1025	10.25	1,300	13
PT80	PT40234P	3/4 x 250	0.1025	25.63	2,250	9
PT80	PT40238P	3/4 x 500	0.1025	51.25	2,500	4
PT80	PT40242P	1 x 100	0.1670	16.70	800	8
PT80	PT40246P	1 x 250	0.1670	41.75	1,000	4
PT80	PT40251P	1 x 500	0.1670	83.50	1,000	2
PT80	PT40254P	1-1/4 x 100	0.2530	25.30	800	8

Visit our website for the most current information.

**NIBCO® PE-RT TUBE**  
POTABLE WATER



**BLUE**

**PT70**



**PE-RT BLUE STICKS**

Figure No.	Material No.	Size	Weight/ Foot	Weight/ Stick	Feet/ Bundle	Pieces/ Bundle
PT70	PT60114P	1/2 x 20	0.0540	1.08	1,000	50
PT70	PT60121P	3/4 x 20	0.1025	2.05	500	25
PT70	PT60127P	1 x 20	0.1670	3.34	300	15

All sticks sold in 5 bundle minimum quantity. Sizes and colors can be mixed to make up the 5 bundle minimum.

**PT70**



**PE-RT BLUE COIL**

Figure No.	Material No.	Size	Weight/ Foot	Weight/ Coil	Feet/ Pallet	Coils/ Pallet
PT70	PT40114P	1/2 x 100	0.0540	5.40	2,000	20
PT70	PT40118P	1/2 x 250	0.0540	13.50	2,500	10
PT70	PT40120P	1/2 x 500	0.0540	27.00	4,000	8
PT70	PT40130P	3/4 x 100	0.1025	10.25	1,300	13
PT70	PT40134P	3/4 x 250	0.1025	25.63	2,250	9
PT70	PT40138P	3/4 x 500	0.1025	51.25	2,500	4
PT70	PT40142P	1 x 100	0.1670	16.70	800	8

Visit our website for the most current information.

# NIBCO® PEX-c TUBE

POTABLE WATER

RED

NP60



## PEX-c RED STICKS

Figure No.	Material No.	Size	Weight/ Foot	Weight/ Stick	Feet/ Bundle	Pieces/ Bundle
NP60	PX60012R*	1/2" x 5'	0.0540	0.27	250	50
NP60	PX60013R*	1/2" x 10'	0.0540	0.54	500	50
NP60	PX60014	1/2" x 20'	0.0540	1.08	1,000	50
NP60	PX60019R*	3/4" x 5'	0.1025	0.51	250	50
NP60	PX60020R*	3/4" x 10'	0.1025	1.03	250	25
NP60	PX60021	3/4" x 20'	0.1025	2.05	500	25
NP60	PX60026R*	1" x 10'	0.1670	1.67	150	15
NP60	PX60027	1" x 20'	0.1670	3.34	300	15
PT80	PT60231P	1-1/4" x 20'	0.2530	5.06	200	10

All sticks sold in 5 bundle minimum quantity. Sizes and colors can be mixed to make up the 5 bundle minimum.

NP60



## PEX-c RED COIL

Figure No.	Material No.	Size	Weight/ Foot	Weight/ Coil	Feet/ Pallet	Coils/ Pallet
NP60	PX40014	1/2" x 100'	0.0540	5.40	2,000	20
NP60	PX40018	1/2" x 250'	0.0540	13.50	2,500	10
NP60	PX40019*	1/2" x 300'	0.0540	16.20	3,000	10
NP60	PX40020	1/2" x 500'	0.0540	27.00	4,000	8
NP60	PX40022	1/2" x 1000'	0.0540	54.00	5,000	5
NP60	PX40030	3/4" x 100'	0.1025	10.25	1,300	13
NP60	PX40035*	3/4" x 300'	0.1025	30.75	2,100	7
NP60	PX40038	3/4" x 500'	0.1025	51.25	5,000	5
NP60	PX40042*	1" x 100'	0.1670	16.70	800	8
NP60	PX40048*	1" x 300'	0.1670	50.10	900	3
NP60	PX40051*	1" x 500'	0.1670	83.50	1,500	3

WHITE

NP80



## PEX-c WHITE STICKS

Figure No.	Material No.	Size	Weight/ Foot	Weight/ Stick	Feet/ Bundle	Pieces/ Bundle
NP80	PX60201*	1/4" x 5'	0.0300	0.15	250	50
NP80	PX60202*	1/4" x 10'	0.0300	0.30	500	50
NP80	PX60203*	1/4" x 20'	0.0300	0.60	1,000	50
NP80	PX60206*	3/8" x 5'	0.0410	0.21	250	50
NP80	PX60207*	3/8" x 10'	0.0410	0.41	500	50
NP80	PX60208*	3/8" x 20'	0.0410	0.82	1,000	50
NP80	PX60212	1/2" x 5'	0.0540	0.27	250	50
NP80	PX60213*	1/2" x 10'	0.0540	0.54	500	50
NP80	PX60214	1/2" x 20'	0.0540	1.08	1,000	50
NP80	PX60219*	3/4" x 5'	0.1025	0.51	125	25
NP80	PX60220*	3/4" x 10'	0.1025	1.03	250	25
NP80	PX60221	3/4" x 20'	0.1025	2.05	500	25
NP80	PX60225*	1" x 5'	0.1670	0.84	75	15
NP80	PX60226R*	1" x 10'	0.1670	1.67	150	15
NP80	PX60227	1" x 20'	0.1670	3.34	300	15
NP80	PX60231	1-1/4" x 20'	0.2530	5.06	200	10

All sticks sold in 5 bundle minimum quantity. Sizes and colors can be mixed to make up the 5 bundle minimum.

\*SKU's are assemble-to-order or made-to-order, and may require longer lead times. Contact customer service or your account representative for details.

Visit our website for the most current information.

# NIBCO® PEX-c TUBE

POTABLE WATER

WHITE

NP80



## PEX-c WHITE COIL

Figure No.	Material No.	Size	Weight/ Foot	Weight/ Coil	Feet/ Pallet	Coils/ Pallet
NP80	PX60204*	1/4" x 25'	0.0300	0.75	2,500	100
NP80	PX40201	1/4" x 100'	0.0300	3.00	4,000	40
NP80	PX40203*	1/4" x 500'	0.0300	15.00	7,500	15
NP80	PX40204*	1/4" x 1000'	0.0300	30.00	5,000	5
NP80	PX60210*	3/8" x 50'	0.0410	2.05	2,500	50
NP80	PX40205	3/8" x 100'	0.0410	4.10	3,500	35
NP80	PX40210*	3/8" x 500'	0.0410	20.50	5,000	10
NP80	PX40212*	3/8" x 1000'	0.0410	41.00	6,000	6
NP80	PX60217*	1/2" x 50'	0.0540	2.70	1,500	30
NP80	PX40214	1/2" x 100'	0.0540	5.40	2,000	20
NP80	PX40219*	1/2" x 300'	0.0540	16.20	3,000	10
NP80	PX40220	1/2" x 500'	0.0540	27.00	4,000	8
NP80	PX40222	1/2" x 1000'	0.0540	54.00	5,000	5
NP80	PX40230	3/4" x 100'	0.1025	10.25	1,300	13
NP80	PX40235*	3/4" x 300'	0.1025	30.75	2,100	7
NP80	PX40238	3/4" x 500'	0.1025	51.25	5,000	5
NP80	PX40242	1" x 100'	0.1670	16.70	800	8
NP80	PX40245*	1" x 200'	0.1670	33.40	1,000	5
NP80	PX40246*	1" x 250'	0.1670	41.75	1,000	4
NP80	PX40248	1" x 300'	0.1670	50.10	1,500	5
NP80	PX40251*	1" x 500'	0.1670	83.50	1,000	2
NP80	PX40254	1-1/4" x 100'	0.2530	25.30	800	8
NP80	PX40255	1-1/4" x 250'	0.2530	63.25	1,000	4

BLUE

NP70



## PEX-c BLUE STICKS

Figure No.	Material No.	Size	Weight/ Foot	Weight/ Stick	Feet/ Bundle	Pieces/ Bundle
NP70	PX60112R*	1/2" x 5'	0.0540	0.27	250	50
NP70	PX60113R*	1/2" x 10'	0.0540	0.54	500	50
NP70	PX60114	1/2" x 20'	0.0540	1.08	1,000	50
NP70	PX60119R*	3/4" x 5'	0.1025	0.51	125	25
NP70	PX60120R*	3/4" x 10'	0.1025	1.03	250	25
NP70	PX60121	3/4" x 20'	0.1025	2.05	500	25
NP70	PX60125R*	1" x 5'	0.1670	0.84	75	15
NP70	PX60117R*	1" x 10'	0.1670	1.67	150	15
NP70	PX60127	1" x 20'	0.1670	3.34	300	15

All sticks sold in 5 bundle minimum quantity. Sizes and colors can be mixed to make up the 5 bundle minimum.

\*SKU's are assemble-to-order or made-to-order, and may require longer lead times. Contact customer service or your account representative for details.

Visit our website for the most current information.

# NIBCO® PEX-c TUBE

POTABLE WATER

BLUE

NP70



## PEX-c BLUE COIL

Figure No.	Material No.	Size	Weight/ Foot	Weight/ Coil	Feet/ Pallet	Coils/ Pallet
NP70	PX60115*	1/2" x 25'	0.0540	1.35	1,250	50
NP70	PX40114	1/2" x 100'	0.0540	5.40	2,000	20
NP70	PX40118	1/2" x 250'	0.0540	13.50	2,500	10
NP70	PX40119*	1/2" x 300'	0.0540	16.20	3,000	10
NP70	PX40120	1/2" x 500'	0.0540	27.00	4,000	8
NP70	PX40122	1/2" x 1000'	0.0540	54.00	5,000	5
NP70	PX60122*	3/4" x 25'	0.1025	2.56	1,000	40
NP70	PX60124*	3/4" x 50'	0.1025	5.13	1,250	25
NP70	PX40130	3/4" x 100'	0.1025	10.25	1,300	13
NP70	PX40135*	3/4" x 300'	0.1025	30.75	2,100	7
NP70	PX40138	3/4" x 500'	0.1025	51.25	5,000	5
NP70	PX40142	1" x 100'	0.1670	16.70	800	8
NP70	PX40148	1" x 300'	0.1670	50.10	900	3
NP70	PX40151*	1" x 500'	0.1670	83.50	1,000	2

## TERRA COTTA

NP65



## PEX-c TERRA COTTA STICKS

Figure No.	Material No.	Size	Weight/ Foot	Weight/ Stick	Feet/ Bundle	Pieces/ Bundle
NP65	PX60506	3/8" x 5'	0.0410	0.21	250	50
NP65	PX60512R	1/2" x 5'	0.0540	0.27	250	50
NP65	PX60513R	1/2" x 10'	0.0540	0.54	500	50
NP65	PX60514	1/2" x 20'	0.0540	1.08	1,000	50
NP65	PX60519R	3/4" x 5'	0.1025	0.51	125	25
NP65	PX60520R	3/4" x 10'	0.1025	1.03	250	25
NP65	PX60521	3/4" x 20'	0.1025	2.05	500	25
NP65	PX60525*	1" x 5'	0.1670	0.84	75	15
NP65	PX60526	1" x 10'	0.1670	1.67	150	15
NP65	PX60527	1" x 20'	0.1670	3.34	300	15

All sticks sold in 5 bundle minimum quantity. Sizes and colors can be mixed to make up the 5 bundle minimum.

\*SKU's are assemble-to-order or made-to-order, and may require longer lead times. Contact customer service or your account representative for details.

Visit our website for the most current information.

# NIBCO® PEX-c TUBE

POTABLE WATER

## TERRA COTTA

### NP65



### PEX-c TERRA COTTA COIL

Figure No.	Material No.	Size	Weight/ Foot	Weight/ Coil	Feet/ Pallet	Coils/ Pallet
NP65	PX60509	3/8" x 25'	0.0410	1.03	1,750	70
NP65	PX40508*	3/8" x 300'	0.0410	12.30	3,000	10
NP65	PX40510*	3/8" x 500'	0.0410	20.50	5,000	10
NP65	PX60515	1/2" x 25'	0.0540	1.35	1,250	50
NP65	PX40514	1/2" x 100'	0.0540	5.40	2,000	20
NP65	PX40518	1/2" x 250'	0.0540	13.50	2,500	10
NP65	PX40519*	1/2" x 300'	0.0540	16.20	3,000	10
NP65	PX40520	1/2" x 500'	0.0540	27.00	4,000	8
NP65	PX60522	3/4" x 25'	0.1025	2.56	1,000	40
NP65	PX40530	3/4" x 100'	0.1025	10.25	1,300	13
NP65	PX40531*	3/4" x 150'	0.1025	15.36	1,500	10
NP65	PX40532*	3/4" x 200'	0.1025	20.50	2,000	10
NP65	PX40534	3/4" x 250'	0.1025	25.63	2,250	9
NP65	PX60528*	1" x 25'	0.1670	4.18	625	25
NP65	PX60530*	1" x 50'	0.1670	8.35	750	15
NP65	PX40542*	1" x 100'	0.1670	16.70	800	8
NP65	PX40544	1" x 150'	0.1670	25.05	900	6
NP65	PX40548	1" x 300'	0.1670	50.10	900	3

## SPOOLS

### NP60

### NP70



### PEX-c SPOOLS

Figure No.	Material No.	Description	Weight/ Foot
NP60	PX40019SP	1/2" X 300' Red Tube On Spool	0.0540
NP70	PX40119SP	1/2" X 300' Blue Tube On Spool	0.0540

\*SKU's are assemble-to-order or made-to-order, and may require longer lead times. Contact customer service or your account representative for details.

Visit our website for the most current information.

# NIBCO® PEX-c TUBE

## ICEMAKER TUBING, RISERS AND INSULATED TUBING

### NP80



### PEX-c ICEMAKER TUBING

Figure No.	Material No.	Size	Weight/ Foot	Weight/ Coil	Feet/ Pallet	Coils/ Pallet
NP80	PX40700	1/8" (1/4" OD) x 100'	0.0300	0.88	2,500	25

### RISERS

- NP45
- NP45F
- NP46
- NP46F
- NP47

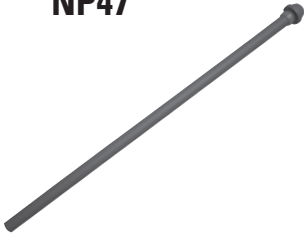

### PEX-c RISER TUBING

Figure No.	Material No.	Size	Weight	Bag Qty	Master Ctn Qty
NP01-LF	PX80521A	1/2"	0.032	50	1,000
NP01R-LF	PX80540A	3/4 x 1/2"	0.056	25	500
NP01-LF	PX80550A	3/4"	0.058	25	500
NP01R-LF	PX80560E	1 x 3/4"	0.093	15	120
NP01-LF	PX80580E	1 1/4"	0.126	25	150

### INSULATED TUBING

### NP90



### INSULATED PEX-c TUBING

Figure No.	Material No.	Description	Weight/ Foot	Weight/ Coil	Feet/ Pallet	Coils/ Pallet
NP90	PX41010	2 x 1" x 75' Insulated PEX	0.8000	60	75	1
NP90	PX41015	2 x 1" x 100' Insulated PEX	0.8000	80	100	1
NP90	PX41020	2 x 1" x 125' Insulated PEX	0.8000	100	125	1
NP90	PX41025	2 x 1" x 150' Insulated PEX	0.8000	120	150	1

### NP90CAP



### INSULATED PEX TUBING ACCESSORIES

Figure No.	Material No.	Description	Weight	Bag Qty	Master Ctn Qty
NP90CAP	PX41005	Insulate PEX End Cap (4 3/4" OD) Legacy	0.4000	1	25
NP90CAP5	PX41006	Insulate PEX End Cap (5 3/4" OD)	0.5000	1	25

Visit our website for the most current information.



# NIBCO® PEX-b TUBE

POTABLE WATER

## RED

### PR60



#### PEX-b RED STICKS

Figure No.	Material No.	Size	Weight/ Foot	Weight/ Stick	Feet/ Bundle	Pieces/ Bundle
PR60	PR60014	1/2 x 20	0.0540	1.08	1,000	50
PR60	PR60021	3/4 x 20	0.1025	2.05	500	25
PR60	PR60027	1 x 20	0.1670	3.34	300	15

All sticks sold in 5 bundle minimum quantity. Sizes and colors can be mixed to make up the 5 bundle minimum.

### PR60



#### PEX-b RED COIL

Figure No.	Material No.	Size	Weight/ Foot	Weight/ Coil	Feet/ Pallet	Coils/ Pallet
PR60	PR40014	1/2 x 100	0.0540	5.40	2,000	20
PR60	PR40018	1/2 x 250	0.0540	13.50	2,500	10
PR60	PR40019	1/2 x 300	0.0540	16.20	3,000	10
PR60	PR40020	1/2 x 500	0.0540	27.00	4,000	8
PR60	PR40022	1/2 x 1000	0.0540	54.00	3,000	3
PR60	PR40030	3/4 x 100	0.1025	10.25	1,300	13
PR60	PR40034	3/4 x 250	0.1025	25.63	2,250	9
PR60	PR40035	3/4 x 300	0.1025	30.75	2,100	7
PR60	PR40038	3/4 x 500	0.1025	51.25	2,000	4
PR60	PR40042	1 x 100	0.1670	16.70	800	8
PR60	PR40048	1 x 300	0.1670	50.10	900	3
PR60	PR40051	1 x 500	0.1670	83.50	1,500	3

## WHITE

### PR80



#### PEX-b WHITE STICKS

Figure No.	Material No.	Size	Weight/ Foot	Weight/ Stick	Feet/ Bundle	Pieces/ Bundle
PR80	PR60214	1/2 x 20	0.0540	1.08	1,000	50
PR80	PR60221	3/4 x 20	0.1025	2.05	500	25
PR80	PR60227	1 x 20	0.1670	3.34	300	15
PR80	PR60231	1-1/4 x 20			200	10

All sticks sold in 5 bundle minimum quantity. Sizes and colors can be mixed to make up the 5 bundle minimum.

### PR80



#### PEX-b WHITE COIL

Figure No.	Material No.	Size	Weight/ Foot	Weight/ Coil	Feet/ Pallet	Coils/ Pallet
PR80	PR40214	1/2 x 100	0.0540	5.40	2,000	20
PR80	PR40219	1/2 x 300	0.0540	16.20	3,000	10
PR80	PR40220	1/2 x 500	0.0540	27.00	4,000	8
PR80	PR40222	1/2 x 1000	0.0540	54.00	5,000	3
PR80	PR40230	3/4 x 100	0.1025	10.25	1,300	13
PR80	PR40235	3/4 x 300	0.1025	30.75	2,100	7
PR80	PR40238	3/4 x 500	0.1025	51.25	2,500	4
PR80	PR40242	1 x 100	0.1670	16.70	800	8
PR80	PR40248	1 x 300	0.1670	50.10	1,500	5
PR80	PR40251	1 x 500	0.1670	83.50	1,000	2
PR80	PR40254	1-1/4 x 100	0.2530	25.30	800	8
PR80	PR40255	1-1/4 x 250	0.2530	63.25	1,000	4

Visit our website for the most current information.

# NIBCO® PEX-b TUBE

POTABLE WATER

**BLUE**

**PR70**



## PEX-b BLUE STICKS

Figure No.	Material No.	Size	Weight/ Foot	Weight/ Stick	Feet/ Bundle	Pieces/ Bundle
PR70	PR60114	1/2 x 20	0.0540	1.08	1,000	50
PR70	PR60121	3/4 x 20	0.1025	2.05	500	25
PR70	PR60127	1 x 20	0.1670	3.34	300	15

All sticks sold in 5 bundle minimum quantity. Sizes and colors can be mixed to make up the 5 bundle minimum.

**PR70**



## PEX-b BLUE COIL

Figure No.	Material No.	Size	Weight/ Foot	Weight/ Coil	Feet/ Pallet	Coils/ Pallet
PR70	PR40114	1/2 x 100	0.0540	5.40	2,000	20
PR70	PR40118	1/2 x 250	0.0540	13.50	2,500	10
PR70	PR40119	1/2 x 300	0.0540	16.20	3,000	10
PR70	PR40120	1/2 x 500	0.0540	27.00	4,000	8
PR70	PR40122	1/2 x 1000	0.0540	54.00	3,000	3
PR70	PR40130	3/4 x 100	0.1025	10.25	1,300	13
PR70	PR40135	3/4 x 300	0.1025	30.75	2,100	7
PR70	PR40138	3/4 x 500	0.1025	51.25	2,000	4
PR70	PR40142	1 x 100	0.1670	16.70	800	8
PR70	PR40148	1 x 300	0.1670	50.10	900	3
PR70	PR40151	1 x 500	0.1670	83.50	1,000	2

# NIBCO® PE-RT TUBE

RADIANT HEAT

**NIBCO**  
**PERTpro™**

**PK75**



## BARRIER-PE-RT STICKS

Figure No.	Material No.	Size	Weight/ Foot	Weight/ Stick	Feet/ Bundle	Pieces/ Bundle
PK75	PK50068	1/2 x 20	0.0535	1.07	500	25
PK75	PK50069	3/4 x 20	0.0760	1.52	200	10
PK75	PK50064	1 x 20	0.1030	2.06	100	5

All sticks sold in 5 bundle minimum quantity. Sizes and colors can be mixed to make up the 5 bundle minimum.

**PK75**



## BARRIER-PE-RT COIL

Figure No.	Material No.	Size	Weight/ Foot	Weight/ Coil	Feet/ Pallet	Coils/ Pallet
PK75	PK50018	1/2 x 250	0.0535	13.38	2,500	20
PK75	PK50019	1/2 x 300	0.0535	16.05	3,000	10
PK75	PK50020	1/2 x 500	0.0535	26.75	4,000	8
PK75	PK50022	1/2 x 1000	0.0535	53.50	3,000	3
PK75	PK50030	3/4 x 100	0.0760	7.60	1,300	13
PK75	PK50034	3/4 x 250	0.0760	19.00	2,250	9
PK75	PK50035	3/4 x 300	0.0760	22.80	2,100	7
PK75	PK50038	3/4 x 500	0.0760	38.00	2,500	5
PK75	PK50041	3/4 x 1200	0.0760	76.00	2,400	2
PK75	PK50042	1 x 100	0.1030	10.30	800	8

Visit our website for the most current information.

# NIBCO® PEX TUBE

## RADIANT HEAT

### NP75



### BARRIER-PEX STICKS

Figure No.	Material No.	Size	Weight/ Foot	Weight/ Stick	Feet/ Bundle	Pieces/ Bundle
NP75	PX50076	1/2" x 5'	0.0535	0.285	500	100
NP75	PX50068	1/2" x 20'	0.0535	1.140	500	25
NP75	PX50061*	3/4" x 5'	0.1023	0.525	200	40
NP75	PX50069	3/4" x 20'	0.1023	2.100	200	10
NP75	PX50073*	1" x 5'	0.1670	0.835	100	20
NP75	PX50064	1" x 20'	0.1670	3.340	100	5

### NP75



### BARRIER-PEX COIL

Figure No.	Material No.	Size	Weight/ Foot	Weight/ Coil	Feet/ Pallet	Coils/ Pallet
NP75	PX50014	1/2" x 100'	0.0535	5.40	2,000	20
NP75	PX50018	1/2" x 250'	0.0535	13.50	2,500	10
NP75	PX50019	1/2" x 300'	0.0535	16.20	3,000	10
NP75	PX50020	1/2" x 500'	0.0535	27.00	4,000	8
NP75	PX50021	1/2" x 600'	0.0535	32.40	4,200	7
NP75	PX50022	1/2" x 1000'	0.0535	54.00	3,000	3
NP75	PX50023	1/2" x 1200'	0.0535	64.80	2,400	2
NP75	PX50029	5/8" x 100'	0.0760	7.60	2,000	20
NP75	PX50024	5/8" x 250'	0.0760	19.00	2,500	10
NP75	PX50026	5/8" x 500'	0.0760	38.00	3,500	7
NP75	PX50028	5/8" x 1000'	0.0760	76.00	3,000	3
NP75	PX50030	3/4" x 100'	0.1030	10.30	1,300	13
NP75	PX50034	3/4" x 250'	0.1030	25.75	2,250	9
NP75	PX50035	3/4" x 300'	0.1030	30.90	2,100	7
NP75	PX50038	3/4" x 500'	0.1030	51.50	2,500	5
NP75	PX50039	3/4" x 600'	0.1030	61.80	1,800	3
NP75	PX50040	3/4" x 1000'	0.1030	103.00	2,000	2
NP75	PX50041	3/4" x 1,200'	0.1030	123.60	2,400	2
NP75	PX50042	1" x 100'	0.1670	16.70	800	8
NP75	PX50048	1" x 300'	0.1670	50.10	900	3
NP75	PX50051	1" x 500'	0.1670	83.50	1,000	2

*BARRIER-PEX is used for radiant systems with ferrous components (e.g. cast iron boiler). The oxygen barrier layer meets the standard DIN 4276.*

\*SKU's are assemble-to-order or made-to-order, and may require longer lead times. Contact customer service or your account representative for details.

Visit our website for the most current information.

# METAL INSERT FITTINGS FOR PEX AND PE-RT LEAD-FREE\* PERFORMANCE BRONZE®

## COUPLINGS

NP01-LF  
NP01R-LF



### COUPLINGS

Figure No.	Material No.	Size	Weight	Bag Qty	Master Ctn Qty
NP01-LF	PX80500X	3/8"	0.018	25	2,000
NP01R-LF	PX80510A	1/2" x 3/8"	0.024	50	1,000
NP01-LF	PX80521A	1/2"	0.032	50	1,000
NP01R-LF	PX80540A	3/4 x 1/2"	0.056	25	500
NP01-LF	PX80550A	3/4"	0.058	25	500
NP01R-LF	PX80560A	1 x 3/4"	0.093	15	120
NP01-LF	PX80570A	1"	0.106	15	120
NP01R-LF	PX80590A	1 1/4 x 3/4"	0.095	10	80
NP01R-LF	PX80600X	1 1/4 x 1"	0.126	10	80
NP01-LF	PX80580E	1 1/4"	0.126	25	150

## ELBOWS

NP07-LF  
NP07R-LF



### ELBOWS

Figure No.	Material No.	Size	Weight	Bag Qty	Master Ctn Qty
NP07-LF	PX80631A	1/2"	0.0440	50	750
NP07R-LF	PX80640A	3/4" x 1/2"	0.1280	25	300
NP07-LF	PX80650A	3/4"	0.0820	25	300
NP07-LF	PX80660A	1"	0.1800	15	150
NP07-LF	PX80670E	1 1/4"	0.2730	10	100

## TEES

NP11-LF  
NP11R-LF

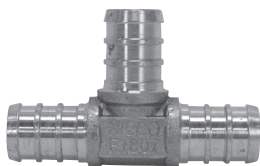

### Tees

Figure No.	Material No.	Size	Weight	Bag Qty	Master Ctn Qty
NP11-LF	PX80711A	1/2"	0.065	50	500
NP11R-LF	PX80720E	1/2 x 1/2" x 3/4"	0.150	25	250
NP11R-LF	PX80730A	3/4 x 1/2" x 1/2"	0.128	25	250
NP11R-LF	PX80740A	3/4 x 1/2" x 3/4"	0.102	25	250
NP11R-LF	PX80750A	3/4 x 3/4" x 1/2"	0.092	25	250
NP11-LF	PX80760A	3/4"	0.125	25	250
NP11R-LF	PX80800A	1 x 1 x 1/2"	0.130	15	120
NP11R-LF	PX80810A	1 x 1" x 3/4"	0.211	15	120
NP11-LF	PX80820X	1"	0.198	10	120
NP11-LF	PX80860X	1 1/4"	0.355	10	60
NP11R-LF	PX80880X	1 1/4" x 1" x 1"	0.289	10	60
NP11R-LF	PX80870E	1 1/4" x 1 1/4" x 1"	0.275	10	80

\*Weighted average lead content ≤ 0.25%

Visit our website for the most current information.

# METAL INSERT FITTINGS FOR PEX AND PE-RT LEAD-FREE\* PERFORMANCE BRONZE®

## STUB OUTS\*

NP21T  
NP21S



### COPPER STUB OUT ELBOWS

Figure No.	Material No.	Description	Weight	Bag Qty	Master Ctn Qty
NP21	PX80950	1/2" Stub Out Elbow (3-1/2" x 8")	0.2580	25	25
NP21	PX80960	3/4" Stub Out Elbow (4" x 8")	0.4120	50	50
NP21S	PX80970	1/2" Stub Out Elbow w/Flange (3-1/2"-8")	0.3070	25	25
NP21S	PX80990	3/4" Stub Out Elbow w/Sq O Strap (4"-8")	0.4860	25	25

NP24A



### COPPER TUB/SHOWER PRESSURE CONNECTIONS

Figure No.	Material No.	Description	Weight	Bag Qty	Master Ctn Qty
NP24A	PX81170	1/2" x 1/2" M Sweat (6x3) Tub/Shw	0.2000	25	25

Visit our website for the most current information.

# METAL INSERT FITTINGS FOR PEX AND PE-RT LEAD-FREE\* PERFORMANCE BRONZE®

## ADAPTERS

### NP22F-LF



#### SWEAT ELBOW ADAPTERS

Figure No.	Material No.	Description	Weight	Bag Qty	Master Ctn Qty
NP22F	PX81030E	3/4" x 3/4" Female Sweat Elbow Adapter	0.1080	10	50

### NP23-LF

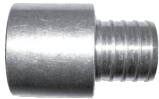

#### MALE SWEAT ADAPTERS

Figure No.	Material No.	Description	Weight	Bag Qty	Master Ctn Qty
NP23-LF	PX81070X	1/2" x 1/2" Male Sweat Adapter	0.032	50	500
NP23-LF	PX81090A	3/4" x 3/4" Male Sweat Adapter	0.064	25	250
NP23-LF	PX81100A	1" x 1" Male Sweat Adapter	0.116	15	120

### NP23F-LF

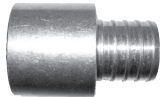

#### FEMALE SWEAT ADAPTERS

Figure No.	Material No.	Description	Weight	Bag Qty	Master Ctn Qty
NP23F-LF	PX81121A	1/2" x 1/2" Female Sweat Adapter	0.032	25	500
NP23F-LF	PX01676X	1/2" x 3/4" Female Sweat Adapter	0.084	50	500
NP23F-LF	PX81130A	3/4" x 3/4" Female Sweat Adapter	0.062	25	250
NP23F-LF	PX81140A	1" x 1" Female Sweat Adapter	0.130	15	120

### NP25B-LF



#### MIP ADAPTERS

Figure No.	Material No.	Description	Weight	Bag Qty	Master Ctn Qty
NP25B-LF	PX81180X	3/8" x 1/2" MIP Brass Adapter	0.080	25	500
NP25B-LF	PX81191A	1/2" x 1/2" MIP Brass Adapter	0.084	25	100
NP25B-LF	PX81200X	1/2" x 3/4" MIP Brass Adapter	0.130	25	250
NP25B-LF	PX81210A	3/4" x 1/2" MIP Brass Adapter	0.087	25	250
NP25B-LF	PX81220X	3/4" x 3/4" MIP Brass Adapter	0.151	10	300
NP25B-LF	PX81250E	3/4" x 1" MIP Brass Adapter	0.209	25	200
NP25B-LF	PX81240A	1" x 3/4" MIP Brass Adapter	0.137	15	120
NP25B-LF	PX81260A	1" x 1" MIP Brass Adapter	0.242	15	120

\*Weighted average lead content ≤ 0.25%

Visit our website for the most current information.

# METAL INSERT FITTINGS FOR PEX AND PE-RT LEAD-FREE\* PERFORMANCE BRONZE®

## ADAPTERS

### NP25BE-LF



### MIP ELBOWS

Figure No.	Material No.	Description	Weight	Bag Qty	Master Ctn Qty
NP25BE-LF	PX81500X	1/2" x 1/2" MIP Elbow	0.1840	50	250
NP25BE-LF	PX81502A	3/4" x 1/2" MIP Elbow	0.1900	25	250

### NP26BS-LF

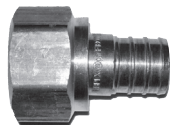

### SWIVEL ADAPTERS

Figure No.	Material No.	Description	Weight	Bag Qty	Master Ctn Qty
NP26BS-LF	PX81340A	1/2" x 3/4" NPSM Swivel Adapter - Brass Nut	0.170	25	50
NP26BS-LF	PX81360A	3/4" x 3/4" NPSM Swivel Adapter - Brass Nut	0.150	25	250

### NP26PS-LF NP44-LF

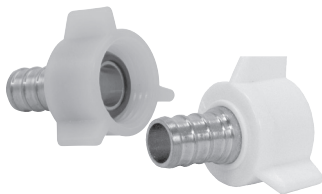

### FAUCET AND SWIVEL ADAPTERS

Figure No.	Material No.	Description	Weight	Bag Qty	Master Ctn Qty
NP26PS-LF	PX81330A	3/8" x Faucet Swivel Adapter - Plastic Nut	0.044	25	50
NP26PS-LF	PX02345A	1/2" x Faucet Swivel Adapter - Plastic Nut	0.048	50	500
NP44-LF	PX81380A	1/2" x Closet Swivel Adapter - Plastic Nut	0.062	10	50

### NP27P-LF

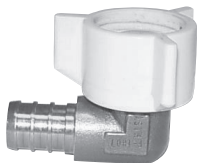

### FAUCET ELBOWS

Figure No.	Material No.	Description	Weight	Bag Qty	Master Ctn Qty
NP27P-LF	PX02245A	1/2 x 1/2" NPSM Faucet Elbow (Plastic Nut)	0.091	50	250

NOTE: Faucet and Swivel Adapters are to be hand tightened ONLY.

### NP26BE-LF



### FEMALE ELBOW NON-SWIVEL ADAPTERS

Figure No.	Material No.	Description	Weight	Bag Qty	Master Ctn Qty
NP26BE-LF	PX81317X	1/2 x 3/4 FIP Elbow Non-Swivel Adapter	0.1610	25	200

\*Weighted average lead content ≤ 0.25%

Visit our website for the most current information.

# METAL INSERT FITTINGS FOR PEX AND PE-RT LEAD-FREE\* PERFORMANCE BRONZE®

## ADAPTERS

### NP26B-LF

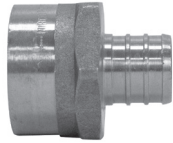

### FIP NON-SWIVEL ADAPTERS

Figure No.	Material No.	Description	Weight	Bag Qty	Master Ctn Qty
NP26B-LF	PX81271A	1/2" x 1/2" FIP Non-Swivel Adapter	0.1200	25	100
NP26B-LF	PX81280X	1/2" x 3/4" FIP Non-Swivel Adapter	0.1320	25	250
NP26B-LF	PX81285X	3/4" x 1/2" FIP Non-Swivel Adapter	0.1320	25	250
NP26B-LF	PX81300A	3/4" x 3/4" FIP Non-Swivel Adapter	0.1650	25	250
NP28B-LF	PX81305X	3/4" x 1" FIP Non-Swivel Adapter	0.1500	15	120
NP26B-LF	PX81310A	1" x 1" FIP Non-Swivel Adapter	0.2280	15	120
NP26B-LF	PX81313E	1 1/4" x 1" FIP Non-Swivel Adapter	0.2290	10	60

## MISCELLANEOUS FITTINGS

### NP18-LF



### PLUGS

Figure No.	Material No.	Description	Weight	Bag Qty	Master Ctn Qty
NP18-LF	PX81450A	1/2"	0.023	50	1,500
NP18-LF	PX81460A	3/4"	0.046	25	1,000
NP18-LF	PX81480E	1"	0.066	15	120
NP18-LF	PX81470E	1 1/4"	0.071	15	120

### NP28-LF



### FIP DROP EAR ELBOWS

Figure No.	Material No.	Description	Weight	Bag Qty	Master Ctn Qty
NP28-LF	PX81400A	1/2" x 1/2" FIP Drop Ear Elbow	0.1780	25	200
NP28-LF	PX81420E	3/4" x 3/4" FIP Drop Ear Elbow	0.2870	25	100

### NP29R-LF



### POLYBUTYLENE TRANSITION FITTINGS

Figure No.	Material No.	Description	Weight	Bag Qty	Master Ctn Qty
NP29R-LF	PX02283A	1/2" x 1/2" PB Transition Fitting w/Rings	0.0500	25	250
NP29R-LF	PX02293A	3/4" x 3/4" PB Transition Fitting w/ Rings	0.1000	25	100

Kit includes fitting, PEX/PE-RT crimp ring, PB crimp ring

### NP100 NP100SW NP101



### COMPRESSION FITTINGS (not for use with potable water)

Figure No.	Material No.	Description	Weight	Bag Qty	Master Ctn Qty
NP100SW	PX81650	1/2" COMP x COMP Coupling	0.0300	10	80
NP01WT083	PX81610	5/8" COMP x COMP Coupling	0.1800	10	80
NP25W7083	PX81600	5/8" COMP x 3/4" Male Sweat	0.1830	10	80
NP100SWM	PX81640	1/2" COMP x 3/4" Male Sweat	0.0300	10	80

\*Weighted average lead content ≤ 0.25%

Visit our website for the most current information.



# PLASTIC INSERT FITTINGS

## NPD01 NPD01R



### POLY COUPLINGS

Figure No.	Material No.	Size	Weight	Bag Qty	Master Ctn Qty
NPD01	PX00508C	3/8"	0.0070	50	2,500
NPD01R	PX00518C	1/2" x 3/8"	0.0070	50	2,000
NPD01	PX00528G	1/2"	0.0020	50	500
NPD01R	PX00538G	3/4" x 1/2"	0.0100	50	500
NPD01	PX00548G	3/4"	0.0100	50	500
NPD01R	PX00558C	3/4" x 1"	0.0200	25	500
NPD01	PX00578C	1"	0.0200	25	500

## NPD07 NPD07R



### POLY ELBOWS

Figure No.	Material No.	Size	Weight	Bag Qty	Master Ctn Qty
NPD07	PX00588G	1/2"	0.0100	50	500
NPD07R	PX00598C	3/4" x 1/2"	0.0200	25	250
NPD07	PX00608G	3/4"	0.0200	25	600
NPD07R	PX00612C	1" x 3/4"	0.0370	25	250
NPD07	PX00618G	1"	0.0500	25	250

## NPD11 NPD11R



### POLY TEES

Figure No.	Material No.	Size	Weight	Bag Qty	Master Ctn Qty
NPD11	PX00628C	3/8"	0.0160	25	1,200
NPD11	PX00638C	1/2"	0.0100	50	500
NPD11R	PX00648C	1/2" x 1/2" x 3/4"	0.0200	25	500
NPD11R	PX00658G	3/4" x 1/2" x 1/2"	0.0200	25	300
NPD11R	PX00668G	3/4" x 1/2" x 3/4"	0.0200	25	400
NPD11R	PX00678C	3/4" x 3/4" x 1/2"	0.0200	25	400
NPD11	PX00688C	3/4"	0.0300	25	300
NPD11R	PX00698C	3/4" x 3/4" x 1"	0.0500	25	300
NPD11R	PX00708C	1" x 3/4" x 3/4"	0.0500	25	250
NPD11R	PX00718C	1" x 3/4" x 1"	0.0500	25	200
NPD11R	PX00728G	1" x 1" x 1/2"	0.0400	25	250
NPD11R	PX00738C	1" x 1" x 3/4"	0.0500	25	250
NPD11	PX00748C	1"	0.0600	25	150

## PLUGS

### NP18P



### POLY PLUGS

Figure No.	Material No.	Size	Weight	Bag Qty	Master Ctn Qty
NP18P	PX01975C	3/8"	0.0060	20	3,000
NP18P	PX01980G	1/2"	0.0060	100	1,000
NP18P	PX01990C	3/4"	0.0130	100	1,000
NP18P	PX01995C	1"	0.1690	25	250

**Note: If poly fittings come in contact with glues, chemicals, sealers, or solvents; they should be discarded.**

Visit our website for the most current information.

# PLASTIC INSERT FITTINGS

## NPD22

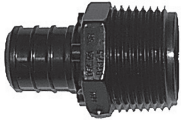

### MALE POLY ADAPTERS

Figure No.	Material No.	Description	Weight	Bag Qty	Master Ctn Qty
NPD22	PX01758C	1/2" x 1/2" MIP Poly Adapter	0.0200	50	500
NPD22	PX01768G	3/4" x 3/4" MIP Poly Adapter	0.0200	25	400
NPD22	PX01778C	1/2" x 3/4" MIP Poly Adapter	0.0180	25	700
NPD22	PX01788C	3/4" x 1/2" MIP Poly Adapter	0.0180	25	600
NPD22	PX01798C	1" MIP Poly Adapter	0.0200	25	300

## NPD25BE



### MALE ELBOW POLY ADAPTERS

Figure No.	Material No.	Description	Weight	Bag Qty	Master Ctn Qty
NPD25BE	PX01948C	1/2" X 3/8" MIP Poly Adapter Elbow	0.0180	25	900
NPD25BE	PX01958C	1/2" X 1/2" MIP Poly Adapter Elbow	0.0180	50	800
NPD25BE	PX01968C	3/4" x 1/2" MIP Poly Adapter Elbow	0.0180	25	500
NPD25BE	PX01978C	3/4" MIP Poly Adapter Elbow	0.0180	25	400
NPD25BE	PX01988C	1" X 3/4" MIP Poly Adapter Elbow	0.0180	25	500

## NPD26 NPD26E



### FEMALE POLY SWIVEL ADAPTERS

Figure No.	Material No.	Description	Weight	Bag Qty	Master Ctn Qty
NPD26	PX01898C	3/4" x 3/4" NPSM Poly Swivel	0.0400	50	500
NPD26	PX02148C	3/8" x 1/2" NPSM Poly Swivel (Faucet)	0.0300	50	600
NPD26	PX01888C	1/2" x 1/2" NPSM Poly Swivel (Faucet)	0.0260	25	500
NPD26C	PX02358C	1/2" x 7/8" NPSM Poly Swivel (Closet/Ballcock)	0.0300	25	400
NPD26E	PX02248C	1/2" x 1/2" NPSM Poly Swivel Elbow (Faucet)	0.0300	10	500
NPD26E	PX02348C	3/4" x 3/4" NPSM Poly Swivel Elbow	0.0300	25	400

**Note: If poly fittings come in contact with glues, chemicals, sealers, or solvents; they should be discarded.**

# MULTIPORT TEES

## NPDCMT

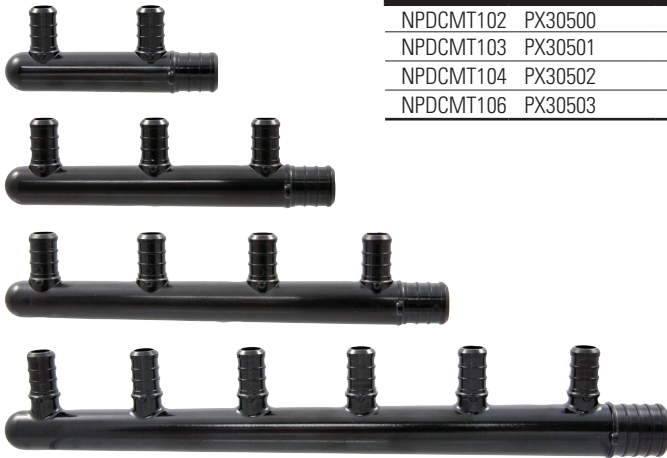

## MULTIPORT TEES - CLOSED

Figure No.	Material No.	Description	Weight	Bag Qty	Master Ctn Qty
NPDCMT102	PX30500	MULTIPORT TEE 3/4" 2-PORT CLOSED	0.036	10	100
NPDCMT103	PX30501	MULTIPORT TEE 3/4" 3-PORT CLOSED	0.054	10	100
NPDCMT104	PX30502	MULTIPORT TEE 3/4" 4-PORT CLOSED	0.072	10	100
NPDCMT106	PX30503	MULTIPORT TEE 1" 6-PORT CLOSED	0.143	10	100

## NPDOMT



## MULTIPORT TEES - OPEN

Figure No.	Material No.	Description	Weight	Bag Qty	Master Ctn Qty
NPDOMT102	PX30504	MULTIPORT TEE 3/4" 2-PORT OPEN	0.039	10	100
NPDOMT103	PX30505	MULTIPORT TEE 3/4" 3-PORT OPEN	0.058	10	100
NPDOMT104	PX30506	MULTIPORT TEE 3/4" 4-PORT OPEN	0.076	10	100
NPDOMT106	PX30507	MULTIPORT TEE 3/4" 6-PORT OPEN	0.112	10	100

Visit our website for the most current information.

# CONNECTIONS (CRIMP, SLEEVE, CLAMP)

## CONNECTIONS

### NP19



#### COPPER CRIMP RINGS

Figure No.	Material No.	Description	Weight	Bag Qty	Master Ctn Qty
NP19	PX80905	3/8" Copper Crimp Ring (black)	0.0110	25	250
NP19	PX80915	1/2" Copper Crimp Ring (black)	0.0130	100	1,000
NP19	PX80925	3/4" Copper Crimp Ring (black)	0.0170	50	500
NP19	PX80935	1" Copper Crimp Ring (black)	0.0220	50	250
NP19	PX80945	1-1/4" Copper Crimp Ring (black)	0.2530	25	250

### NP19CS



#### COPPER CRIMP SLEEVES

Figure No.	Material No.	Description	Weight	Bag Qty	Master Ctn Qty
NP19CS	PX80911	1/2" Copper Crimp Sleeve	0.019	50	600
NP19CS	PX80921	3/4" Copper Crimp Sleeve	0.028	50	500
NP19CS	PX80931	1" Copper Crimp Sleeve	0.031	50	250

### NP50



#### STAINLESS STEEL SLEEVES

Figure No.	Material No.	Description	Weight	Bag Qty	Master Ctn Qty
NP50	PX02110	1/2" SS Sleeve	0.0060	50	5,000
NP50	PX02120	3/4" SS Sleeve	0.0100	50	2,500
NP50	PX02130	1" SS Sleeve	0.0100	50	2,500

Visit our website for the most current information.

# HOME RUN MANIFOLD®



## 6-PORT AND 12-PORT MANIFOLDS - LEAD FREE\* 1" CTS Trunk, 3/4" and 1" End Connections, 1/2" Ports

All manifolds (except bulk models) come with:

- Mounting clip(s) and screws
- Hot and cold label sheets
- Mounting template
- Instructions



6-Port



12-Port

Figure No.	Material No.	Description	Trunk Joints		Valves 1/2"	Dimensions		
			END 1	END2		Length	Width	Height
PM6-A	PX90002	6-Port Manifold	None	None	No	16"	3"	1-1/8"
PM6-LF	PX90003E	6-Port Manifold	1"	1" Plug	No	17-1/4"	3"	1-1/8"
PM6-LF	PX90004E	6-Port Manifold	3/4"	1" Plug	No	17-1/8"	3"	1-1/8"
PM6-V1-LF	PX90005E	6-Port Manifold w/Valves	1"	1" Plug	6	17-1/4"	3"	1-1/8"
PM6-V1-LF	PX90006E	6-Port Manifold w/Valves	3/4"	1" Plug	6	17-1/8"	3"	1-1/8"
PM6-B	PX90069	6-Port Manifold - Bulk	None	None	No	16"	3"	1-1/8"
PM6-P-LF	PX90067E	6-Port Manifold - 1" Plug Ends	1" Plug	1" Plug	No	16"	3"	1-1/8"
PM12-LF	PX90007E	12-Port Manifold	1"	1" Plug	No	34-3/8"	3"	1-1/8"
PM12-LF	PX90008E	12-Port Manifold	3/4"	1" Plug	No	33-7/8"	3"	1-1/8"
PM12-V1-LF	PX90009E	12-Port Manifold w/Valves	1"	1" Plug	12	34-3/8"	3"	1-1/8"
PM12-V1-LF	PX90010E	12-Port Manifold w/Valves	3/4"	1" Plug	12	33-7/8"	3"	1-1/8"
PM12-P-LF	PX90068E	12-Port Manifold - 1" Plug Ends	1" Plug	1" Plug	No	34-3/8"	3"	1-1/8"

\*Weighted average lead content ≤ 0.25%

Visit our website for the most current information.



# HOME RUN MANIFOLD®

**8-PORT AND 16-PORT MANIFOLDS - LEAD FREE\***  
**1 1/4" CTS Trunk, 3/4", 1" and 1-1/4" End Connections, 1/2" Ports**

V1 Models - 1/2" Valves

All manifolds (except bulk models) come with:

- Mounting clip(s) and screws
- Hot and cold label sheets
- Mounting template
- Instructions



8-Port

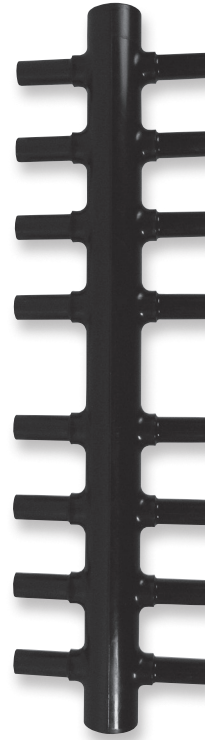

16-Port

Figure No.	Material No.	Description	Trunk Joints		Valves 1/2"	Dimensions		
			END 1	END2		Length	Width	Height
PH8-A	PX90011	8-Port Manifold	None	None	No	9-1/8"	5"	1-3/8"
PH8-LF	PX90012E	8-Port Manifold	1-1/4"	1-1/4" Plug	No	10-1/2"	5"	1-3/8"
PH8-LF	PX90013E	8-Port Manifold	1"	1-1/4" Plug	No	10-1/4"	5"	1-3/8"
PH8-LF	PX90014E	8-Port Manifold	3/4"	1-1/4" Plug	No	10-1/8"	5"	1-3/8"
PH8-V1-LF	PX90015E	8-Port Manifold w/valves	1-1/4"	1-1/4" Plug	8	10-1/2"	5"	1-3/8"
PH8-V1-LF	PX90016E	8-Port Manifold w/valves	1"	1-1/4" Plug	8	10-1/4"	5"	1-3/8"
PH8-V1-LF	PX90017E	8-Port Manifold w/valves	3/4"	1-1/4" Plug	8	10-1/8"	5"	1-3/8"
PH16-A	PX90021	16-Port Manifold	None	None	No	18-1/4"	5"	1-3/8"
PH16-LF	PX90022E	16-Port Manifold	1-1/4"	1-1/4" Plug	No	20-1/2"	5"	1-3/8"
PH16-LF	PX90023E	16-Port Manifold	1"	1-1/4" Plug	No	20-1/4"	5"	1-3/8"
PH16-LF	PX90024E	16-Port Manifold	3/4"	1-1/4" Plug	No	20-1/8"	5"	1-3/8"
PH16-LF	PX90088E	16-Port Manifold 1" FIP	1" FIP	1-1/4" Plug	No	20-1/4"	5"	1-3/8"
PH16-V1-LF	PX90025E	16-Port Manifold w/valves	1-1/4"	1-1/4" Plug	16	20-1/2"	5"	1-3/8"
PH16-V1-LF	PX90026E	16-Port Manifold w/valves	1"	1-1/4" Plug	16	20-1/4"	5"	1-3/8"
PH16-V1-LF	PX90027E	16-Port Manifold w/valves	3/4"	1-1/4" Plug	16	20-1/8"	5"	1-3/8"

\*Weighted average lead content ≤ 0.25%

Visit our website for the most current information.

# HOME RUN MANIFOLD®



**16, 24, 32 AND 40-PORT  
DUAL TEMPERATURE MANIFOLDS - LEAD FREE\***  
1 1/4" CTS Trunk, 3/4", 1" and 1-1/4" End Connections, 1/2" Ports

V1 Models - 1/2" Valves

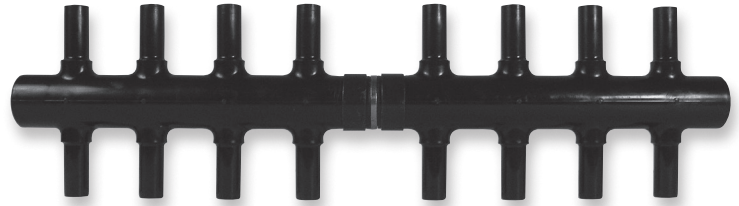

16-Port Dual Temperature

All manifolds (except bulk models) come with:

- Mounting clip(s) and screws
- Hot and cold label sheets
- Mounting template
- Instructions

Manifold Size	Side A	Side B
16-Port	8	8
24-Port	16	8
32-Port	16	16
40-Port	24	16

Figure No.	Material No.	Description	Trunk Joints		Valves 1/2"	Dimensions		
			END 1	END2		Length	Width	Height
PH16D-LF	PX90031E	16-Port DUAL TEMP	1-1/4"	1-1/4"	No	20-1/2"	5"	1-3/8"
PH16D-LF	PX90032E	16-Port DUAL TEMP	1"	1"	No	20-1/4"	5"	1-3/8"
PH16D-LF	PX90033E	16-Port DUAL TEMP	3/4"	3/4"	No	20"	5"	1-3/8"
PH16D-V1-LF	PX90034E	16-Port DUAL TEMP w/valves	1-1/4"	1-1/4"	16	20-1/2"	5"	1-3/8"
PH16D-V1-LF	PX90035E	16-Port DUAL TEMP w/valves	1"	1"	16	20-1/4"	5"	1-3/8"
PH16D-V1-LF	PX90036E	16-Port DUAL TEMP w/valves	3/4"	3/4"	16	20"	5"	1-3/8"
PH24D-LF	PX90040E	24-Port DUAL TEMP	1-1/4"	1-1/4"	No	29-1/2"	5"	1-3/8"
PH24D-LF	PX90041E	24-Port DUAL TEMP	1"	1"	No	29-1/8"	5"	1-3/8"
PH24D-LF	PX90042E	24-Port DUAL TEMP	3/4"	3/4"	No	28-3/4"	5"	1-3/8"
PH24D-V1-LF	PX90043E	24-Port DUAL TEMP w/valves	1-1/4"	1-1/4"	24	29-1/2"	5"	1-3/8"
PH24D-V1-LF	PX90044E	24-Port DUAL TEMP w/valves	1"	1"	24	29-1/8"	5"	1-3/8"
PH24D-V1-LF	PX90045E	24-Port DUAL TEMP w/valves	3/4"	3/4"	24	28-3/4"	5"	1-3/8"
PH32D-LF	PX90049E	32-Port DUAL TEMP	1-1/4"	1-1/4"	No	38-3/4"	5"	1-3/8"
PH32D-LF	PX90050E	32-Port DUAL TEMP	1"	1"	No	38-1/2"	5"	1-3/8"
PH32D-LF	PX90051E	32-Port DUAL TEMP	3/4"	3/4"	No	38-1/8"	5"	1-3/8"
PH32D-V1-LF	PX90052E	32-Port DUAL TEMP w/valves	1-1/4"	1-1/4"	32	38-3/4"	5"	1-3/8"
PH32D-V1-LF	PX90053E	32-Port DUAL TEMP w/valves	1"	1"	32	38-1/2"	5"	1-3/8"
PH32D-V1-LF	PX90054E	32-Port DUAL TEMP w/valves	3/4"	3/4"	32	38-1/8"	5"	1-3/8"
PH40D-LF	PX90058E	40-Port DUAL TEMP	1-1/4"	1-1/4"	No	48"	5"	1-3/8"
PH40D-LF	PX90059E	40-Port DUAL TEMP	1"	1"	No	47-3/4"	5"	1-3/8"
PH40D-LF	PX90060E	40-Port DUAL TEMP	3/4"	3/4"	No	47-3/8"	5"	1-3/8"
PH40D-V1-LF	PX90061E	40-Port DUAL TEMP w/valves	1-1/4"	1-1/4"	40	48"	5"	1-3/8"
PH40D-V1-LF	PX90062E	40-Port DUAL TEMP w/valves	1"	1"	40	47-3/4"	5"	1-3/8"
PH40D-V1-LF	PX90063E	40-Port DUAL TEMP w/valves	3/4"	3/4"	40	47-3/8"	5"	1-3/8"

\*Weighted average lead content ≤ 0.25%

Visit our website for the most current information.

# HOME RUN MANIFOLD® & COPPER MANIFOLDS



## HOME RUN MANIFOLD® ACCESSORIES

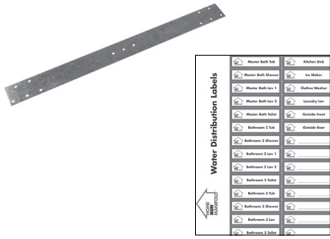

Water Distribution Labels	Material No.	Description
<input type="checkbox"/>	PX90072	Home Run Manifold Sheet of ID Labels - COLD
<input type="checkbox"/>	PX90073	Home Run Manifold Sheet of ID Labels - HOT
<input type="checkbox"/>	PX90080	PH Manifold Stud Strap
<input type="checkbox"/>	PX90077	Mounting Clip for 1" Trunk
<input type="checkbox"/>	PX90078	Mounting Clip for 1-1/4" Trunk
<input type="checkbox"/>	PX14151	Access Panel 14" x 29"
<input type="checkbox"/>	PX14152	Access Panel 14" x 38"
<input type="checkbox"/>	PX01022	8 Br Cp Manifold Open 3/4" x 1/2" Out

Figure No.	Material No.	Description	Weight	Box Qty	Master Ctn Qty
PMLC	PX90072	Home Run Manifold Sheet of ID Labels - <b>COLD</b>	0.0030	100	1000
PMLH	PX90073	Home Run Manifold Sheet of ID Labels - <b>HOT</b>	0.0030	100	1000
PHSTRAP	PX90080	PH Manifold Stud Strap	0.0550	50	500
NP42	PX90077	Mounting Clip for 1" Trunk	0.0100	—	400
NP42	PX90078	Mounting Clip for 1-1/4" Trunk	0.0190	—	400
NP200	PX14151	Access Panel 14" x 29"	4.1500	1	10
NP200	PX14152	Access Panel 14" x 38"	4.3600	1	10
NP208	PX01022	8 Br Cp Manifold Open 3/4" x 1/2" Out	1.0080	—	25

## COPPER MANIFOLDS

**NP203, NP203C**  
**NP204, NP205,**  
**NP205C, NP206C**  
**NP208, NP208C**

## BRANCH MANIFOLDS

Figure No.	Material No.	Description	Weight	Box Qty	Master Ctn Qty
NP203	PX01000	3 Br Cp Manifold Open 3/4" x 1/2" Out	0.5120	—	25
NP203C	PX01009	3 Br Cp Manifold Closed 3/4" x 1/2" Out	0.4520	—	25
NP204	PX01012	4 Br Cp Manifold Open 3/4" x 1/2" Out	0.5600	—	25
NP204C	PX01013	4 Br Cp Manifold Closed 3/4" x 1/2" Out	0.6580	—	25
NP208	PX01022	8 Br Cp Manifold Open 3/4" x 1/2" Out	1.0080	—	25

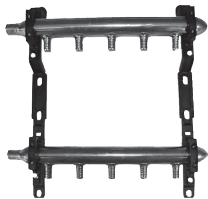
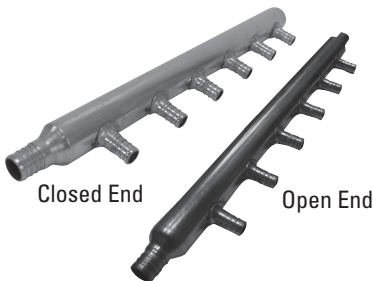

## MANIFOLD BRACKET

Figure No.	Material No.	Description	Weight	Box Qty	Master Ctn Qty
11555	PX10299	Manifold Bracket	0.5000	1	10

**NP204V, NP204VC**  
**NP205V, NP205VC**  
**NP206V, NP206VC**

## VALVE MANIFOLDS

Figure No.	Material No.	Description	Weight	Box Qty	Master Ctn Qty
NP203V	PX01027	3 Br 1" Manifold F x M Swt w/Valves	1.6000	1	10
NP205V	PX01029	5 Br 1" Manifold F x M Swt w/Valves	2.3000	1	10
NP204V	PX01130	4 Br Manifold w/Valve Open 3/4" x 3/4" x 1/2" Out	1.8460	1	10
NP204VC	PX01100	4 Br Manifold w/Valve Closed 3/4" x 1/2" Out	1.8040	1	10

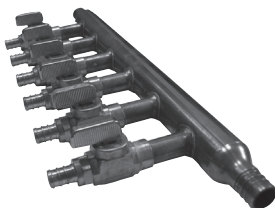

Visit our website for the most current information.



# VALVES

## VALVES

### PXCP400-LF, NPR50A-LF

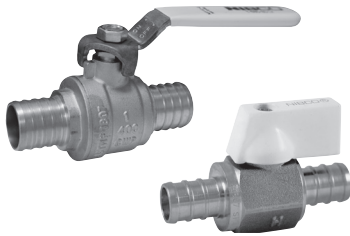

### LEAD-FREE\* BALL VALVES

Figure No.	Material No.	Description	Weight	Bag Qty	Master Ctn Qty
PXCP400-LF	PX01526X	1/2" Brass Ball Valve w/ LH	0.2500	18	18
PXCP400-LF	PX01546X	3/4" Brass Ball Valve w /LH	0.4100	12	12
PXCP400-LF	PX01566X	1" Brass Ball Valve w/ LH	0.5700	6	6
NPR50A-LF	PX10297X	1/2" Mini Brass Ball Valve	0.1500	10	100



### STRAIGHT STOP VALVES

Figure No.	Material No.	Description	Weight	Bag Qty	Master Ctn Qty
NP7160-LF	ND615L8	1/2" x 1/4" OD (Icemaker) Straight Stop	0.1530		5
7160-LF	ND618L6	Straight Supply Stop 1/2" x 3/8"OD	0.1520		10
7160PEX-LF	ND618L7	Straight Supply Stop 1/2" x 1/2"	0.1340		10
7160M-LF	ND618L5	1/2" x 1/2" Male Straight Supply Stop	0.1590		10



### ANGLE STOP VALVES

Figure No.	Material No.	Description	Weight	Bag Qty	Master Ctn Qty
7165-LF	ND615L9	1/2" x 1/4"OD (Icemaker) Angle Supply Stop	0.1650		5
7165-LF	ND619L6	Angle Supply Stop 1/2" x 3/8" OD	0.1640		10
7165PEX-LF	ND619L7	1/2" x Angle Stop	0.1480	5	200

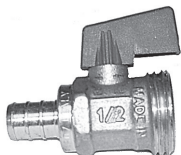

### OTHER VALVES

Figure No.	Material No.	Description	Weight	Bag Qty	Master Ctn Qty
NP7170	PX01521E	1/2" x Hose Thread Valve	0.1500	10	150

\*Weighted average lead content ≤ 0.25%

Visit our website for the most current information.

# RADIANT HEATING

# NIBCO PEX

RADIANT SYSTEMS

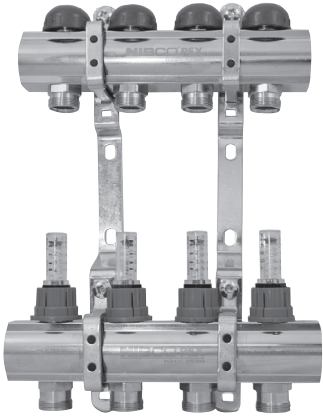

**RADIANT HEAT MANIFOLD**

## RADIANT MANIFOLDS AND ACCESSORIES

Figure No.	Material No.	Description	Weight	Box Qty
NR1	PX10502	NR 2 PORT 1" Radiant Heat Manifold	7.7000	1
NR1	PX10503	NR 3 PORT 1" Radiant Heat Manifold	8.9500	1
NR1	PX10504	NR 4 PORT 1" Radiant Heat Manifold	11.1600	1
NR1	PX10505	NR 5 PORT 1" Radiant Heat Manifold	12.3700	1
NR1	PX10506	NR 6 PORT 1" Radiant Heat Manifold	13.8000	1
NR1	PX10507	NR 7 PORT 1" Radiant Heat Manifold	14.7000	1
NR1	PX10508	NR 8 PORT 1" Radiant Heat Manifold	15.6700	1
NR1	PX10509	NR 9 PORT 1" Radiant Heat Manifold	18.2100	1
NR1	PX10510	NR 10 PORT 1" Radiant Heat Manifold	20.1700	1
NR1	PX10541	NR Valve Set for Manifold 1" FIP Straight	3.1700	1
NR1	PX10542	NR Valve Set for Manifold 1" FIP Angle	2.9420	1
NR1	PX10552	NR Manifold 1/2" Connector	0.1280	10
NR1	PX10554	NR Manifold 5/8" Connector	0.1280	10
NR1	PX10546	NR Fill & Purge Set w/ Air Vents	1.2800	1
NR1	PX10548	NR Actuator 24VAC NC - 2 Wire	0.3200	1



**FIP Valve Set  
Straight**  
2 per set



**FIP Valve Set  
Angle**  
2 per set



**Fill & Purge Set  
w/Air Vents**  
2 per set



**Actuator**



**PEX/PE-RT Connector**

Visit our website for the most current information.

# RADIANT HEATING

# NIBCO PEX

RADIANT SYSTEMS

**NPRHP**  
**NPR180C**  
**NPR90HP2T**

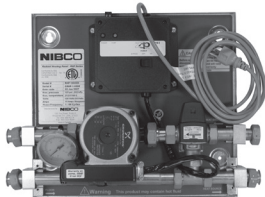

## RADIANT HEAT PANELS

Figure No.	Material No.	Description	Weight	Bag Qty	Master Ctn Qty
NPRHP	PX10231	RHP Radiant Heat Panel	11.8000	1	1
NPRHP	PX10232	RHP-1 Radiant Heat Panel	18.4000	1	1
NPRHP	PX10233	RHP-2 Radiant Heat Panel	22.4000	1	1
NPRHP	PX10234	RHP-2-4 Radiant Heat Panel	25.6500	1	1
NPRHP	PX10235	RHP 3 Radiant Heat Panel	43.0500	1	1
NPR180C	PX10246	Zone Kit For RHP 2-4	1.7000	1	1
NPR90HP2T	PX10247	Radiant Heat Panel - Tankless	23.0000	1	1

## PARTS & ACCESSORIES FOR PANELS

Figure No.	Material No.	Description	Weight	Bag Qty	Master Ctn Qty
NPR310ZV	PX10306	3/4" NPT Zone Valve w/ Union	.950	1	10
NPR315A	PX10308	Actuator 24V For Zone Valve	.330	1	10
NPR285TW	PX10312	FH Thermostat w/ Floor Sensor	.350	1	10
NPR285T	PX10313	FH Thermostat Only	.112	1	25
NPR290TW	PX10314	Floor Sensor	.080	1	25

**NPR230PMV**  
**NPR240PMV**  
**NPR250PMV**  
**NPR260PMV**  
**NPR211C**

## RADIANT PUMPS

Figure No.	Material No.	Description	Weight	Bag Qty	Master Ctn Qty
NPR230PMV	PX10289	Grundfos® 1558 3-Speed Bronze Pump Union Connection	3.7800	1	1
NPR194GP	PX10344X	Pump Connection Kit Sweat for PX10289	0.0100	1	10

Visit our website for the most current information.

# RADIANT HEATING

# NIBCO PEX

RADIANT SYSTEMS

## NPR120TP

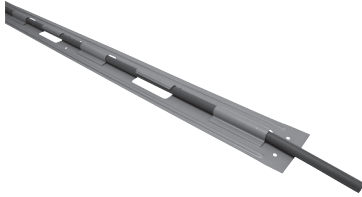

### HEAT TRANSFER PLATES

Figure No.	Material No.	Description	Weight	Bag Qty	Master Ctn Qty
NPR120TP	PX10251	Rad-Trax™ Easy Install Heat Transfer Plate	1.7000	1	20

## NPR10A, 11032



### RADIANT ACCESSORIES

Figure No.	Material No.	Description	Weight	Bag Qty	Master Ctn Qty
NPR10A	PX10296	Thermometer, Strap On	0.2500	1	25
11032	PX10300R	Radiant DVD/CD-ROM	0.3000	30	60
NPPP	PX10328	PEX-Pal Tube Holder	0.6560		40
NPPPEP	PX10329	PEX-Pal End Plate	0.1480		10

## NPR145C, NPR150C NPR160C, NPR170C NPR305FC NPR305WMC

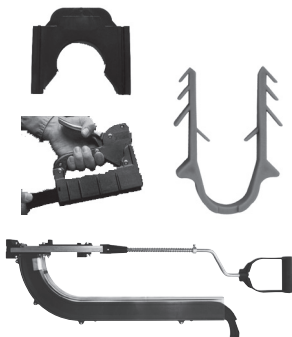

### RADIANT TUBING CLIPS

Figure No.	Material No.	Description	Weight	Bag Qty	Master Ctn Qty
NPR170C	PX10271	1/2" Clips (Legacy)	0.0100	100	10,000
NPR170C	PX10272	3/4" Clips (Legacy)	0.3500	100	10,000
NPR145C	PX10273	Reddi-Strip®* Stand Up Staple Gun	10.9500	1	1
NPR150C	PX10274	Reddi-Strip®* Staples - Box of 200	0.6500	1	50
NPR305FC	PX71250	1/2" Clips for Styrofoam	0.0080	25	1,600
NPR305WMC	PX71251	1/2" Clips for Wire Mesh	0.0160	25	1,000

\* Reddi-Strip® is a registered trademark of Peter Mangone, Inc.

Visit our website for the most current information.

# CRIMP & SLEEVE TOOLS

COPPER CRIMP RINGS OR COPPER CRIMP SLEEVES

**NP32C**  
**NP32S**



## CRIMP TOOLS - COMPACT

Figure No.	Material No.	Description	Weight	Bag Qty	Master Ctn Qty
NP32C	PX02505	3/8" Compact Crimp Tool w/gauge (12")	2.1000	1	20
NP32C	PX02515	1/2" Compact Crimp Tool w/gauge (12")	2.0500	1	10
NP32S	PX02540	3/4" Compact Crimp Tool w/gauge(12")	2.0000	1	10
NP32S	PX02530	1/2" Compact Crimp Tool	2.0000	1	10

**NP32CH**  
**NP32LH**



## CRIMP TOOLS - STANDARD

Figure No.	Material No.	Description	Weight	Bag Qty	Master Ctn Qty
NP32CH	PX02529	Standard 3/8" Crimp Tool	3.0000	1	10
NP32CH	PX02532	Standard 1/2" Crimp Tool	3.0000	1	10
NP32CH	PX02531	Standard 3/4" Crimp Tool	3.0000	1	10
NP32CH	PX02533	Standard 1" Crimp Tool	3.2500	1	10
NP32LH	PX02545	1-1/4" Long Handle Crimp Tool w/gauge (19")	6.0000	1	10

**NP32B**  
**NP33C**

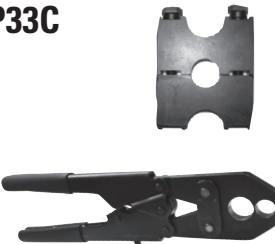

## CRIMP TOOLS - ECONOMY & COMBO

Figure No.	Material No.	Description	Weight	Bag Qty	Master Ctn Qty
NP32B	PX02555	1/2" & 3/4" Block Combo Crimp Tool	0.8500	1	50
NP32B	PX02565	3/8" & 1" Block Combo Crimp Tool	0.9000	10	40
NP33C4IN1	PX01385	3/8", 1/2", 3/4", 1" Block Tool w/gauge	1.1500	1	50
NP32MH	PX02585	1/2" & 3/4" Combo Mid-Handle Crimp Tool	3.4000	1	12
NP33C	PX01340	Combo 1/2" & 3/4" Crimp Tool (12")	4.0000	1	10

STAINLESS STEEL SLEEVES

**NP52**  
**NP52C**



## SLEEVE TOOLS

Figure No.	Material No.	Description	Weight	Bag Qty	Master Ctn Qty
NP52	PX01364C	1/2" Sleeve Tool (12")	3.1000	1	16
NP52C	PX01365	1/2" Compact Sleeve Tool	2.0000	1	10
NP52	PX01366C	3/4" Sleeve Tool (12")	4.0000	1	16
NP52	PX01368	1" Sleeve Tool (12")	4.5000	1	12

Visit our website for the most current information.

## TOOLS & ACCESSORIES

### NP32DC



### OTHER TOOLS & ACCESSORIES

Figure No.	Material No.	Description	Weight	Bag Qty	Master Ctn Qty
NP32DC	PX02575	Decrimping Tool For All Size Rings	0.6000	1	50
NP34	PX01384	3/8" - 1" Go/No Go Gauge	0.1500	10	300
NP34	PX01381	1-1/4" Go/No Go Gauge	0.1000	1	
NP35	PX01360	1/2" - 3/4" Easy Cut Tool	0.3000	1	50
NP35	PX01390	3/8" - 1-1/4" Pipe Cutter	0.3400	1	50
NP37	PX01415	Tube Uncoiler	35.4000	1	1

### NP34



### NP35

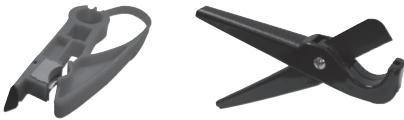

### NP37

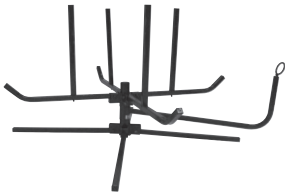

Visit our website for the most current information.

# MINI PRESSING TOOL AND CRIMP JAWS



**PC-20M**



**PCX-200M**



**PCX-1M**  
**PCX-2M**  
**PCX-3M**  
**PCX-6M**  
**PCX-7M**

## PC-20M MINI PRESSING TOOL & CRIMP JAWS

Figure No.	Material No.	Description	Weight	Box Qty
PC-20M	R00205PC	Mini Pressing Tool, 2 - 18V, 1.3 Ah Lithium-ion batteries, 110V charger & case (NO jaws)	17.20	1
PCX-200M	R00205PCX	Mini Pressing Tool, 3 Crimp Jaws (1/2", 3/4" & 1"), 1/2", 3/4", & 1" Gauge, 2 - 18V, 1.3 Ah Lithium-ion batteries, 110V charger & case	18.05	1
PCX-1M	R00215PCX	1/2" Crimp Jaw for PC-20M and PC-10M (Includes 1/2", 3/4", & 1" Gauge)	2.94	1
PCX-6M	R00240PCX	5/8" Crimp Jaw for PC-20M and PC-10M (Includes 5/8", 1-1/4" Gauge)	2.97	1
PCX-2M	R00220PCX	3/4" Crimp Jaw for PC-20M and PC-10M (Includes 1/2", 3/4", & 1" Gauge)	2.90	1
PCX-3M	R00230PCX	1" Crimp Jaw for PC-20M and PC-10M (Includes 1/2", 3/4", & 1" Gauge)	2.92	1
PCX-7M	R00250PCX	1-1/4" Crimp Jaw for PC-20M and PC-10M (Includes 5/8", 1-1/4" Gauge)	3.11	1
PC-4ML	R00245PC	18V, 1.3Ah Lithium-ion Battery for PC-20M	0.80	1
PC-7L	R00175PC	18V, 3.0Ah Lithium-ion Battery for PC-20M	1.30	1
PC-8L	R00187PC	110V Battery Charger for PC-4ML and PC-7L	2.20	1
PC-9L	R00195PC	AC Adapter for PC-20M	1.70	1
PC-4M	R00240PC	1.3 Ah NiCd 9.6V Battery for PC-10M	1.85	1
PC-5M	R00250PC	120V Charger for PC-10M	1.13	1
NP34	PX01388	Go/No Go Crimp Gauge (1/2", 3/4", 1")	0.85	1
NP34	PX01389	Go/No Go Crimp Gauge (5/8", 1-1/4")	0.85	1



**PC-7L**  
18V, 3.0 Ah  
Lithium-ion Battery



**PC-8L**  
110V Battery Charger



**PC-4M**  
9.6V, 1.3 Ah NiMH Battery



**PC-4ML**  
18V, 1.3 Ah  
Lithium-ion Battery



**PC-9L**  
AC Adapter



**PC-5M**  
120V Battery Charger

Visit our website for the most current information.

## INSTALLATION ACCESSORIES

### NP38



#### TUBE TALON

Figure No.	Material No.	Description	Weight	Bag Qty	Master Ctn Qty
NP38	PX02000	3/8" CTS Tube Talon w/Nail	0.0080	100	1,000
NP38	PX02010	1/2" CTS Tube Talon w/Nail	0.0110	100	1,000
NP38	PX02020	3/4" CTS Tube Talon w/Nail	0.0160	100	1,000
NP38	PX02030	1" CTS Tube Talon w/Nail	0.0240	50	500

### NP39

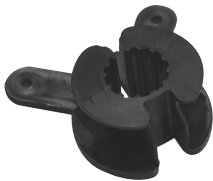

#### INSULATOR CLAMPS

Figure No.	Material No.	Description	Weight	Bag Qty	Master Ctn Qty
NP39	PX02040	3/8" Tubing Insulator Clamp	0.0210	50	500
NP39	PX02050	1/2" Tubing Insulator Clamp	0.0230	50	500
NP39	PX02060	3/4" Tubing Insulator Clamp	0.0190	50	500
NP39	PX02070	1" Tubing Insulator Clamp	0.0170	25	250

### NP40, NP40N NP40P



Plastic Bend Support



Metal Bend Support

#### BEND SUPPORTS

Figure No.	Material No.	Description	Weight	Bag Qty	Master Ctn Qty
NP40	PX02080	1/2" CTS Metal Bend Support	0.1010	50	50
NP40P	PX02083	1/2" Plastic Bend Support	0.0800	25	250
NP40P	PX02084	3/4" Plastic Bend Support	0.1600	10	80
NP40P	PX02086	1" Plastic Support Bend	0.2600	5	50

Visit our website for the most current information.





**NIBCO INC. LIMITED WARRANTY**  
Applicable to NIBCO INC. PEX Piping Systems

NIBCO INC. warrants that when NIBCO® PEX tube is used with NIBCO® PEX fittings, and NIBCO® valves and installation accessories, they will, under normal conditions, use and service in potable water and radiant heat systems, be free from defects in materials and workmanship for a period of twenty-five (25) years from the date of purchase when installed by a licensed professional contractor. This 25-year warranty is voided if any non-NIBCO products are used in the PEX system. NIBCO INC. warrants NIBCO PEX tube, when used under normal conditions, use and service in potable water and radiant heat systems with brass insert fittings meeting NSF/ANSI 61, ASTM F1807 and ASTM F877 to be free from defects in materials and workmanship for a period of ten (10) years from the date of purchase. NIBCO INC. warrants NIBCO® PEX fittings, manifolds, transition fittings and valves under normal conditions, use and service in potable water and radiant heat systems, to be free from defects in materials and workmanship for a period of ten (10) years from the date of purchase. NIBCO INC. warrants NIBCO® associated hardware and tools for a period of 90 days from the date of purchase.

In the event any defect occurs which the owner believes is covered by this warranty, the owner should immediately contact NIBCO Technical Services, either in writing or by telephone at 1.888.446.4226 or 1.574.295.3000. The owner will be instructed to return said tube, fittings or accessories, at the owner's expense, to NIBCO INC., or an authorized representative for inspection. In the event said inspection discloses to the satisfaction of NIBCO INC. that said tube, fitting or accessory is defective, a replacement shall be mailed free of charge to the owner.

IN ORDER FOR THIS LIMITED WARRANTY TO APPLY, THE ABOVE REFERENCED PRODUCTS MUST BE INSTALLED BY A LICENSED PROFESSIONAL PLUMBER IN ACCORDANCE WITH NIBCO INSTALLATION INSTRUCTIONS AND IN COMPLIANCE WITH ALL APPLICABLE CODE REQUIREMENTS. FAILURE TO DO SO WILL VOID ALL APPLICABLE WARRANTIES.

This warranty does not apply and you do not have a right of reimbursement if the failure or resulting damage is caused by:

1. breaks, tearing, kinking, gouges, punctures or other external damages before, during, or after installation;
2. exposure to temperatures and pressures beyond the product ratings as specified on the product or in the NIBCO installation manual;
3. exposure to damaging chemicals, substances or corrosive water conditions;
4. damage from abnormal operating conditions;
5. damage due to accident, abuse, misuse, or unauthorized modification or repair;
6. improper installation due to worn, damaged, unauthorized or improperly calibrated tools;
7. components in the plumbing system other than those manufactured or sold by NIBCO;
8. not designing, installing, inspecting or testing the system in accordance with NIBCO installation instructions at the time of the installation; or
9. failure to follow applicable code requirements and good plumbing practices.

TO THE EXTENT PERMITTED BY LAW, THIS WARRANTY SPECIFICALLY EXCLUDES INCIDENTAL AND CONSEQUENTIAL DAMAGES OF EVERY TYPE AND DESCRIPTION RESULTING FROM ANY CLAIMED DEFECT IN MATERIAL OR WORKMANSHIP, INCLUDING BUT NOT LIMITED TO, PERSONAL INJURIES AND PROPERTY DAMAGES.

Some states or countries do not allow the exclusion or limitation of incidental or consequential damages so these limitations may not apply to you.

TO THE EXTENT PERMITTED BY LAW, IMPLIED WARRANTIES OF MERCHANTABILITY AND FITNESS FOR A PARTICULAR PURPOSE ARE LIMITED IN DURATION.

This warranty gives you specific legal rights, and you may also have other rights which vary from state to state and country to country.



To the best of our knowledge, the information contained in this publication is accurate. However, NIBCO does not assume any liability whatsoever for the accuracy or completeness of such information. Final determinations of the suitability of any information or product for the use to be contemplated is the sole responsibility of the user. The manner of that use, and whether there is any infringement of patents, is also the sole responsibility of the user.

Visit our website for the most current information.



**NIBCO INC. LIMITED WARRANTY**  
Applicable to NIBCO INC. PE-RT Piping Systems

NIBCO INC. warrants that when NIBCO® PE-RT tube is used with NIBCO® fittings, and NIBCO® valves and installation accessories, they will, under normal conditions, use and service in potable water and radiant heat systems, be free from defects in materials and workmanship for a period of twenty-five (25) years from the date of purchase when installed by a licensed professional contractor. This 25-year warranty is voided if any non-NIBCO products are used in the PE-RT system. NIBCO INC. warrants NIBCO PE-RT tube, when used under normal conditions, use and service in potable water and radiant heat systems with brass insert fittings meeting NSF/ANSI 61, ASTM F1807 and ASTM F877 to be free from defects in materials and workmanship for a period of ten (10) years from the date of purchase. NIBCO INC. warrants NIBCO® PEX fittings, manifolds, transition fittings and valves under normal conditions, use and service in potable water and radiant heat systems, to be free from defects in materials and workmanship for a period of ten (10) years from the date of purchase. NIBCO INC. warrants NIBCO® associated hardware and tools for a period of 90 days from the date of purchase.

In the event any defect occurs which the owner believes is covered by this warranty, the owner should immediately contact NIBCO Technical Services, either in writing or by telephone at 1.888.446.4226 or 1.574.295.3000. The owner will be instructed to return said tube, fittings or accessories, at the owner's expense, to NIBCO INC., or an authorized representative for inspection. In the event said inspection discloses to the satisfaction of NIBCO INC. that said tube, fitting or accessory is defective, a replacement shall be mailed free of charge to the owner.

IN ORDER FOR THIS LIMITED WARRANTY TO APPLY, THE ABOVE REFERENCED PRODUCTS MUST BE INSTALLED BY A LICENSED PROFESSIONAL PLUMBER IN ACCORDANCE WITH NIBCO INSTALLATION INSTRUCTIONS AND IN COMPLIANCE WITH ALL APPLICABLE CODE REQUIREMENTS. FAILURE TO DO SO WILL VOID ALL APPLICABLE WARRANTIES.

This warranty does not apply and you do not have a right of reimbursement if the failure or resulting damage is caused by:

1. breaks, tearing, kinking, gouges, punctures or other external damages before, during, or after installation;
2. exposure to temperatures and pressures beyond the product ratings as specified on the product or in the NIBCO installation manual;
3. exposure to damaging chemicals, substances or corrosive water conditions;
4. damage from abnormal operating conditions;
5. damage due to accident, abuse, misuse, or unauthorized modification or repair;
6. improper installation due to worn, damaged, unauthorized or improperly calibrated tools;
7. components in the plumbing system other than those manufactured or sold by NIBCO;
8. not designing, installing, inspecting or testing the system in accordance with NIBCO installation instructions at the time of the installation; or
9. failure to follow applicable code requirements and good plumbing practices.

TO THE EXTENT PERMITTED BY LAW, THIS WARRANTY SPECIFICALLY EXCLUDES INCIDENTAL AND CONSEQUENTIAL DAMAGES OF EVERY TYPE AND DESCRIPTION RESULTING FROM ANY CLAIMED DEFECT IN MATERIAL OR WORKMANSHIP, INCLUDING BUT NOT LIMITED TO, PERSONAL INJURIES AND PROPERTY DAMAGES.

Some states or countries do not allow the exclusion or limitation of incidental or consequential damages so these limitations may not apply to you.

TO THE EXTENT PERMITTED BY LAW, IMPLIED WARRANTIES OF MERCHANTABILITY AND FITNESS FOR A PARTICULAR PURPOSE ARE LIMITED IN DURATION.

This warranty gives you specific legal rights, and you may also have other rights which vary from state to state and country to country.



To the best of our knowledge, the information contained in this publication is accurate. However, NIBCO does not assume any liability whatsoever for the accuracy or completeness of such information. Final determinations of the suitability of any information or product for the use to be contemplated is the sole responsibility of the user. The manner of that use, and whether there is any infringement of patents, is also the sole responsibility of the user.

Visit our website for the most current information.

# NOTES

*Visit our website for the most current information.*

# NOTES

*Visit our website for the most current information.*

# NOTES

*Visit our website for the most current information.*

## NIBCO® PE-RT/PEX

### QUICK REFERENCE GUIDE

Crimp Ring After Crimping		
Size	Min	Max
3/8	0.5800	0.5950
1/2	0.7000	0.7150
3/4	0.9450	0.9600
1	1.1750	1.1900
1-1/4	1.4300	1.4450

Stick Bundle Qty	
Size	Sticks
3/8"	50
1/2"	50
3/4"	25
1"	15
1-1/4"	10

R-Value	
Size	Sticks
1/2"	0.028
3/4"	0.038
1"	0.049
1-1/4"	0.060

**Expansion**  
PEX / PE-RT expands and contracts at a rate of 1.1" per 100 feet of pipe for each 10°F change in temperature

**Operating Limits**  
ASTM F2023 Test Conditions:  
Chlorinated water 80psi @ 140°  
Non-chlorinated 100psi @ 180°

**Support Spacing**  
< 1-1/4" 32" Maximum  
= 1-1/4" 48" Maximum  
Vertical runs must be supported at the half-story level

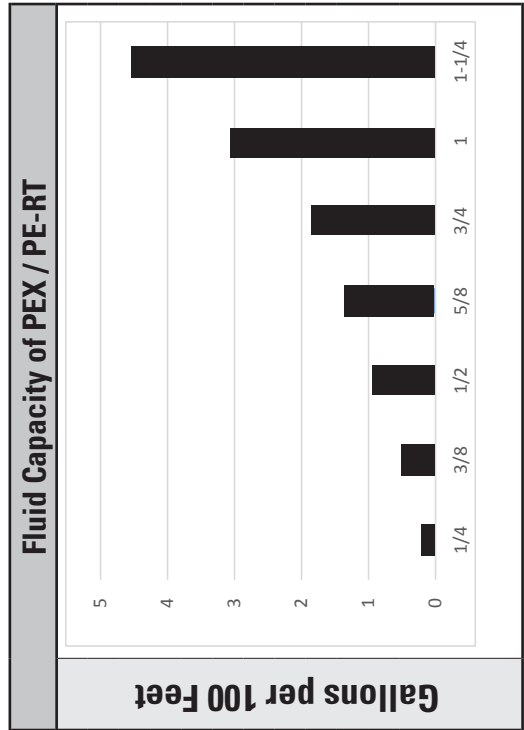

Nominal Size	OD / ID				Computed ID
	OD	Tol	Wall Thickness	Tol	
1/8	0.250	+/- .003	0.047	+ .007	0.156
1/4	0.375	+/- .003	0.062	+ .010	0.251
3/8	0.500	+/- .003	0.070	+ .010	0.360
1/2	0.625	+/- .004	0.070	+ .010	0.485
5/8	0.750	+/- .004	0.083	+ .010	0.584
3/4	0.875	+/- .004	0.097	+ .010	0.681
1	1.125	+/- .005	0.125	+ .013	0.875
1-1/4	1.375	+/- .005	0.153	+ .015	1.069

in inches

GPM	Pressure Drop Table PSI/Ft				
	3/8"	1/2"	5/8"	3/4"	1" 1 1/4"
1	0.071	0.0160	0.006		
2	0.254	0.0580	0.021		
4	0.538	0.1220	0.045		
5		0.2070	0.076	0.0540	
6		0.3130	0.115	0.0760	
7		0.4390	0.161	0.1010	
8		0.5840	0.214	0.1300	
9			0.224	0.1610	0.0510
10			0.340	0.1960	0.0620
12.5				0.2740	0.1320
15				0.4140	0.2240
20					0.3390
25					0.127
30					0.178
40					0.304
50					0.459

Pressure Drop x 2.307 = Feet of Head

Size	Coils per Pallet			
	100'	250'	500'	1000'
1/4	40	30	15	
3/8	28	15	10	8
1/2	20	10	8	6
5/8	20	8	7	3
3/4	13	9	7	4
1	20	5	3	
1-1/4	8	4		

Weight / Foot	
Size	Wt/Ft
1/8	0.0160
1/4	0.0300
3/8	0.0410
1/2	0.0540
5/8	0.0760
5/8 SW	0.0630
3/4	0.1025
7/8 SW	0.0900
1	0.1670
1-1/4	0.2530

in lbs

Bend Radius	
Size	BR
1/4	4"
3/8	5"
1/2	6"
3/4	9"
1	11"
1-1/4	14"

MPG	
	MPG
Potable Tubing	N1
Metal Fittings	N2
PEX Valves	N3
Radiant Tube	N4
Plastic Insert Ftgs	N5
Plastic Push Ftgs	N6
Radiant Accessories	N7
Copper Manifolds	N8
Tools	N9
Power Tools	NA
Plastic Manifolds	NB
Crimp Rings Stubouts	NC
PE-RT Potable	ND
PE-RT Barrier	NE

Visit our website for the most current information.

globally connecting you at all levels

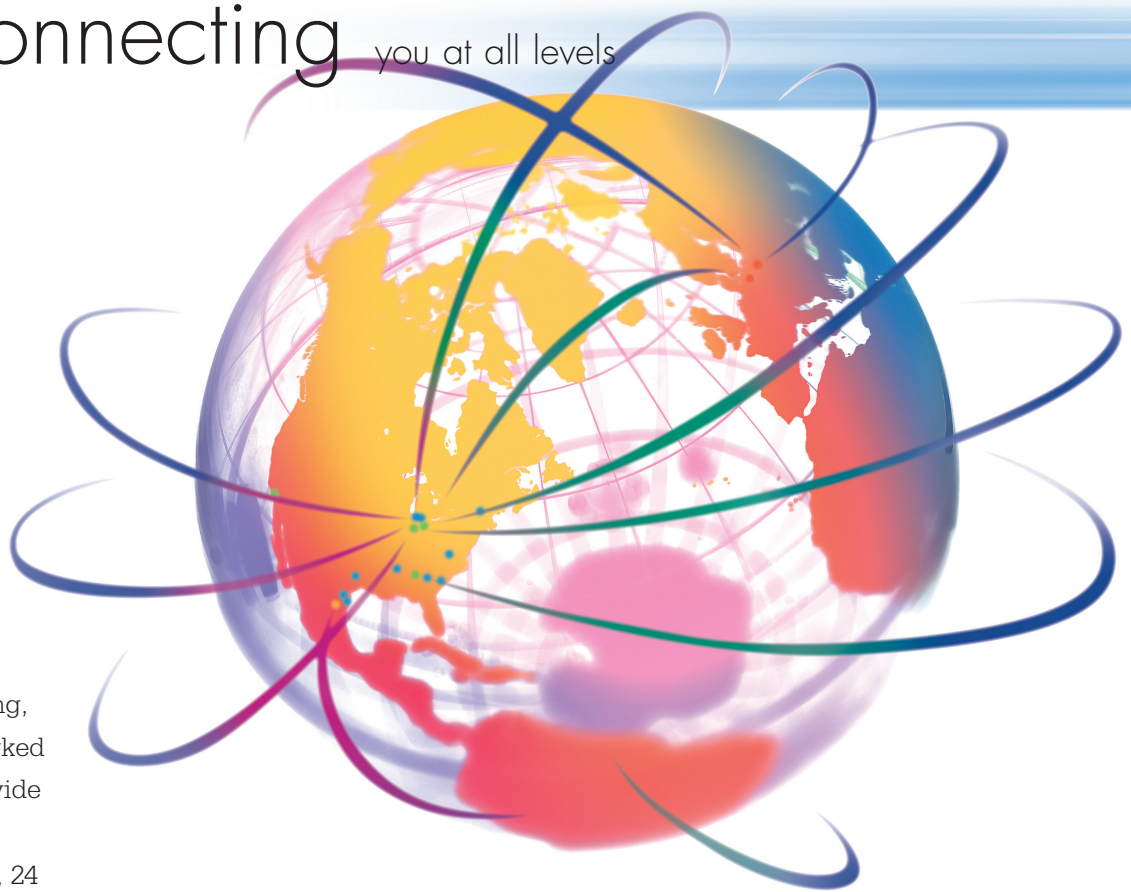

It's a new age of business, and a new way at NIBCO. From Elkhart, Indiana to Lodz, Poland, and points beyond, our company has integrated manufacturing, distribution, and networked communications to provide a seamless source of information and service, 24 hours a day, 7 days a week. But this integration hasn't happened overnight. It's been part of a long-term strategic process that has pushed us to reconsider every aspect of our business. The result? We're a vertically integrated manufacturer with the products and systems in place to deliver low cost and high quality. NIBCO products are manufactured under a Quality Management System conforming to the current revision of ISO-9001 International Standards. We know the flow control industry is only going to get more demanding, and we are more than ready. We will continue to lead. That's what NIBCO is all about.

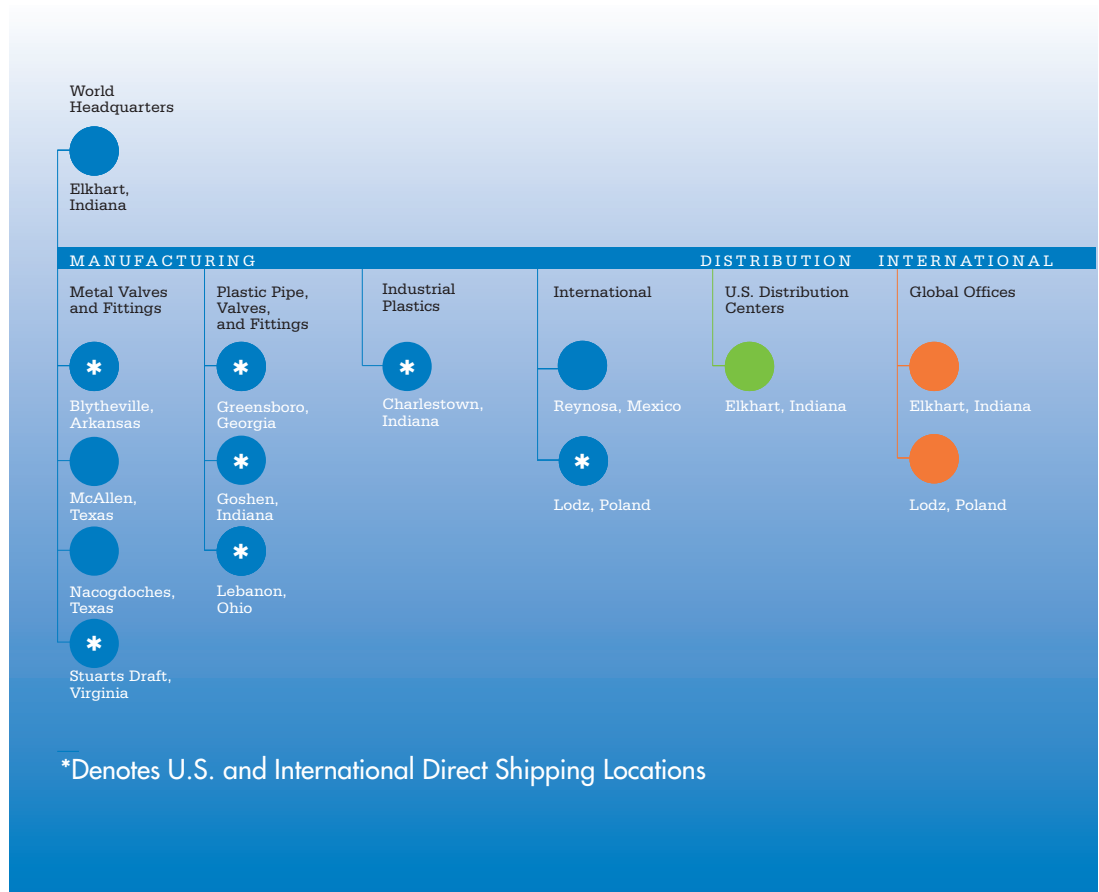

# FEATURING NIBCO® SYSTEMS

C-FLEX-0317

NIBCO® PEX Piping Systems • NIBCO® Press System®

## FITTINGS

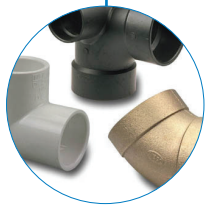

Wrot and cast copper pressure and drainage fittings • Cast copper alloy flanges  
• Wrot and cast press fittings • ABS and PVC DWV fittings • Schedule 40 PVC pressure fittings • CPVC CTS fittings • CPVC CTS-to-metal transition fittings  
• Schedule 80 PVC and CPVC systems • CPVC metric piping systems  
• CPVC BlazeMaster® fire protection fittings • Lead-Free\* fittings

BlazeMaster® is a registered trademark of The Lubrizol Corporation.  
\*Weighted average lead content ≤0.25%

## VALVES & ACTUATION

Pressure-rated bronze, iron and alloy-iron gate, globe and check valves • Pressure-rated bronze ball valves • Boiler specialty valves • Commercial and industrial butterfly valves • Circuit balancing valves • Carbon and stainless steel ball valves  
• ANSI flanged steel ball valves • Pneumatic and electric actuators and controls  
• Grooved ball and butterfly valves • High performance butterfly valves • UL/FM fire protection valves • MSS specification valves • Bronze specialty valves • Low pressure gate, globe, check and ball valves • Frostproof sillcocks • Quarter-turn supply stops • Quarter-turn low pressure valves • PVC ball valves • CPVC CTS ball valves • Bronze & Iron Y-Strainers • Lead-Free\* valves • Coil-Connect™ Kits

\*Weighted average lead content ≤0.25%



## CHEMTROL®



Thermoplastic pipe, valves and fittings in PVC, Corzan® CPVC, polypropylene and PVDF Kynar® • Pneumatic and electric actuation systems

Corzan® is a registered trademark of The Lubrizol Corporation. • Kynar® is a registered trademark of Arkema Inc.

## eNIBCO

EDI—Electronic Data Interchange • VMI—Vendor Managed Inventory  
• NIBCO.com • NIBCOpartner.com



**NIBCO®**  
AHEAD OF THE FLOW®

**NIBCO INC.**  
**WORLD HEADQUARTERS**  
WEB: [www.nibco.com](http://www.nibco.com)

1516 MIDDLEBURY STREET  
ELKHART, IN 46516-4740  
USA

DOMESTIC CUSTOMER SERVICE  
PHONE: 800.234.0227  
FAX: 800.234.0557

TECHNICAL SERVICE  
PHONE: 888.446.4226  
FAX: 888.336.4226

INTERNATIONAL OFFICE  
PHONE: +1/574.295.3327  
FAX: +1/574.295.3455